



THE WAY TO BE  
**CISCO WARRIOR**  
TEORY & PRACTICE

# PREFACE

Assalammu'alaykum wr wb

Alhamdulillah buku ini dapat terselesaikan. Buku ini adalah buku penunjang untuk belajar ilmu jaringan khususnya CISCO. InshaAllah buku ini juga akan digunakan untuk pertama kalinya dalam training “Pesantren Networkers Mengajar”.

CISCO merupakan salahsatu vendor perangkat terbesar dalam dunia jaringan. Selain CISCO, ada juga Mikrotik dan Juniper. Kesemuanya mempunyai sertifikasinya masing-masing. Misalkan di CISCO ada CCNA (Cirsco Certified Network Academy), CCNP (Cirsco Certified Network Professional) dan CCIE (Cisco Certified Internetwork Expert).

Dalam buku ini dituliskan teori dan praktek step by step sehingga mudah diikuti. Walaupun buku ini lebih focus pada CISCO, namun secara teori, sama dengan yang lain semisal Mikrotik dan Juniper. Yang berbeda hanyalah pada commandnya. Dan dalam CISCO, materinya bisa dibilang adalah yang paling lengkap.

Pada akhirnya penulis berharap buku ini bermanfaat dan tidak lupa mengucapkan rasa terimakasih kepada pihak yang telah banyak membantu terselesaikannya buku ini: Pak Dedi, Alam, Ikhwan, Mas Aries, Mas Ali, Mas Bram, Pak Anshori, Mas Rofiq, Mas Okky, teman-teman Pesantren Networkers, SMK IDN dan keluarga ID-Networkers dan teman-teman Ponpes Madinatul Quran.

Wassalammu alaykum wr wb

Jakarta, 29 April 2015

Muhammad Taufik

# CONTENT

## NETWORK FUNDAMENTALS

Pengertian Jaringan  
Jaringan berdasarkan Area  
OSI Layer  
Perangkat Jaringan dan Simbol  
IP Address  
Ethernet Cable  
Subnetting So Easy  
Contoh Soal Subnetting  
Subnetting Challenge  
Broadcast Domain dan Collision Domain  
Perbedaan Hub, Bridge, Switch dan Router

## CHAPTER 1 SWITCHING

Perintah Dasar Switch & Router Cisco  
Konfigurasi Password pada Cisco  
Virtual LAN (VLAN)  
Trunking VLAN  
Inter-VLAN - Router on a Stick  
Inter-VLAN – Switch Layer 3  
DHCP menggunakan Switch  
Port Security  
Spanning Tree Protocol (STP)  
STP Portfast  
Etherchannel

VLAN Trunking Protocol (VTP)

## **CHAPTER 2 ROUTING**

Static Routing

Default Routing

Enhanced Interior Gateway Protocol (EIGRP)

Open Shortest Path First (OSPF)

Standard Access List

Extended Access List

Static NAT

Overloading/Port Address Translation (PAT)

HSRP

## **CHAPTER 3 IPv6**

IPv6 Basic Link-Local

IPv6 Basic Global Unicast

IPv6 Basic EUI-64

IPv6 Static Routing

IPv6 RIPnG

IPv6 EIGRP

IPv6 OSPFv3

IPv6 IPv6IP Tunneling

IPv6 GRE IP Tunneling

IPv6 Tunnel 6to4

IPv6 Tunnel ISATAP

IPv6 Tunnel Auto-TunnelTER 3 IPV6

## **CHAPTER 4 EIGRP**

EIGRP Basic Configuration

EIGRP Filtering - Distribute List

EIGRP Filtering - Prefix List  
EIGRP Filtering - Access List  
EIGRP Filtering - Administrative Distance  
EIGRP Authentication  
EIGRP Summarization  
EIGRP Unicast Update  
EIGRP Default Route – Summary Address  
EIGRP Redistribution - RIP  
EIGRP Redistribution - OSPF  
EIGRP Path Selection - Delay  
EIGRP Path Selection - Bandwidth  
EIGRP Equal Load Balancing  
EIGRP Unequal Load Balancing  
EIGRP Stub – Connected + Summary  
EIGRP Stub – Connected  
EIGRP Stub – Summary  
EIGRP Stub – Static  
EIGRP Stub – Redistributed  
EIGRP Stub – Receive Only

## **CHAPTER 5 OSPF**

OSPF Basic Configuration  
OSPF Virtual Link  
OSPF GRE Tunnel  
OSPF Standar Area  
OSPF Stub Area  
OSPF Totally Stub Area  
OSPF Not So Stubby Area (NSSA)  
OSPF External Route Type 1  
OSPF Summarization – Area Range  
OSPF Summarization – Summary Address

OSPF Path Selection

## **CHAPTER 6 BGP**

BGP - iBGP Configuration

BGP - iBGP Update via Loopback

BGP – eBGP Configuration

BGP – eBGP Configuration 2

BGP – eBGP Configuration 3

BGP – Next Hop Self

BGP – Authentication

BGP Route Reflector

BGP Attribute - Origin

BGP Attribute - Community

BGP Attribute - Community Local-AS and Configuring Confederation

BGP Aggregator

BGP Attribute - Weight

BGP Dualhoming – Load Balance

BGP Dualhoming – Set Weight

BGP Dualhoming – Set MED

BGP Dualhoming – Set AS Path

BGP Multihoming – Equal Load Balance

BGP Multihoming – Unequal Load Balance

# NETWORK FUNDAMENTALS

Pengertian Jaringan  
Jaringan berdasarkan Area  
OSI Layer  
Perangkat Jaringan dan Simbol  
IP Address  
Ethernet Cable  
Subnetting So Easy  
Contoh Soal Subnetting  
Subnetting Challenge  
Broadcast Domain dan Collision Domain  
Perbedaan Hub, Bridge, Switch dan Router

# Network Fundamentals

## Pengertian Jaringan

Jaringan atau network adalah kumpulan perangkat jaringan (network devices) dan perangkat endhost (end devices) yang terhubung satu sama lain dan dapat melakukan sharing informasi serta resources.

Komponen pembentuk jaringan:

- Network devices: hub, bridge, switch dan router.
- End devices: PC, laptop, mobile, dll.
- Interconnection: NIC, konektor, media (cooper, fiber optic, wireless, dll).

## Jaringan berdasarkan Area

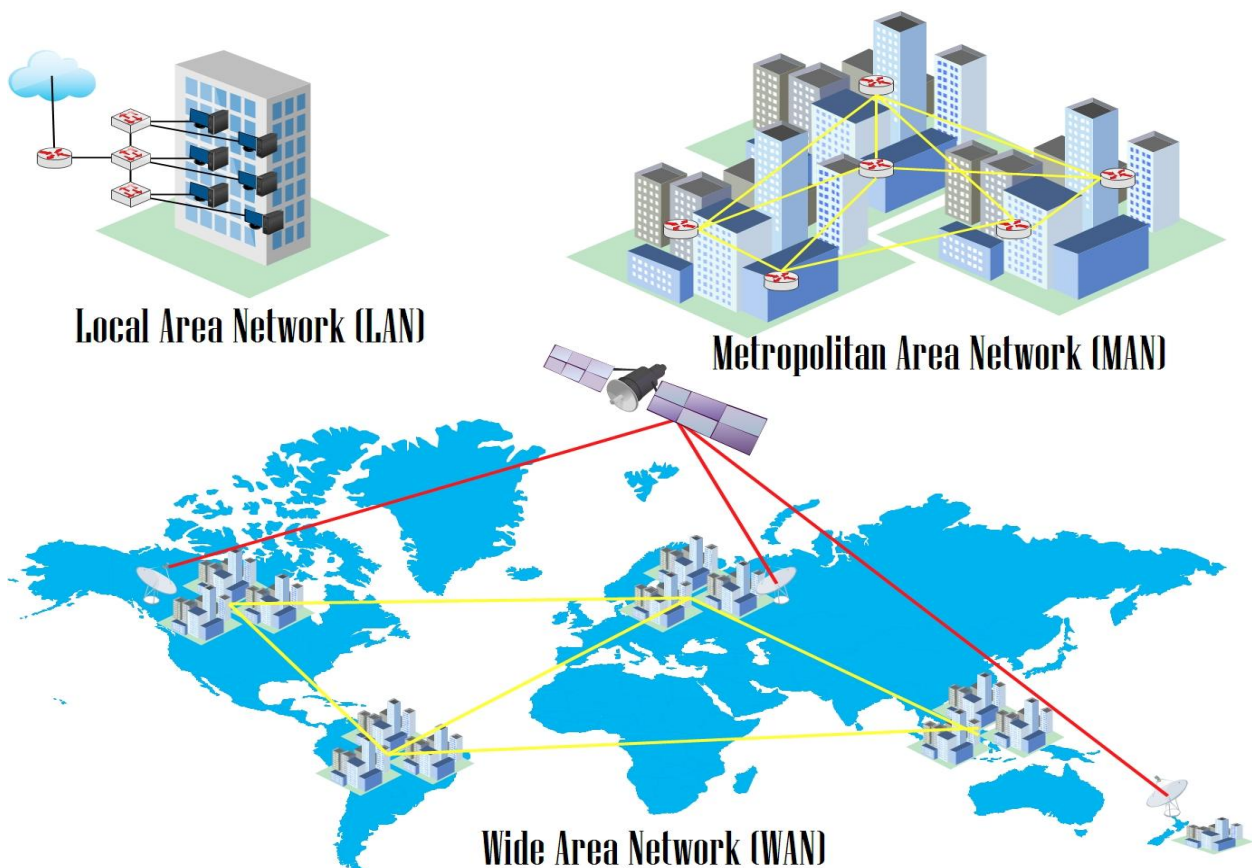

Gambar Jaringan berdasarkan area



- Local Area Network (LAN) merupakan jaringan sederhana dalam satu gedung, kantor, rumah atau sekolah. Biasanya menggunakan kabel UTP.
- Metropolitan Area Network (MAN) adalah gabungan dari banyak LAN dalam suatu wilayah.
- Wide Area Network (WAN) adalah jaringan yang menghubungkan banyak MAN antar pulau, negara atau benua. Mediana dapat berupa fiber optic dan satelit.

## OSI Layer

Adalah standar dalam perangkat jaringan yang membuat berbagai perangkat kompatibel satu sama lain. Ada 7 layer dalam OSI layer, dari bawah layer 1 physical sampai atas layer 7 application.

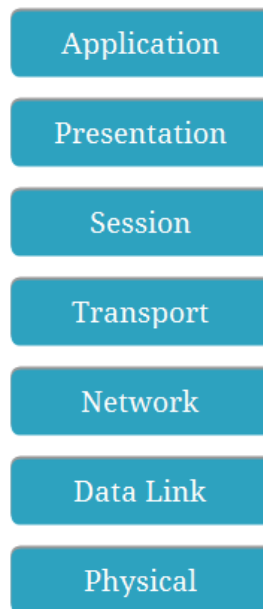

Gambar OSI Layer

Seorang engineer wajib memahami layer 1 sampai 4 untuk memahami fungsi dan cara kerja perangkat jaringan.

	Layer	Perangkat	Data Unit	Pengalamatan
1	Physical	Hub	Bit	Binnary (1 or 0)
2	Data Link	Bridge dan Switch	Frame	MAC Address
3	Network	Router	Packet	IP Address

	Layer	Perangkat	Konektivitas	Memory
1	Physical	Hub	Broadcast ke semua port	-
2	Data Link	Bridge dan Switch	Broadcast berdasarkan MAC Address	MAC Address Tabel
3	Network	Router	Berdasarkan IP Address tujuan	Routing Tabel

## Perangkat Jaringan dan Simbol

Seorang network engineer harus mengetahui berbagai jenis perangkat jaringan dan simbolnya agar dapat membaca topologi jaringan.

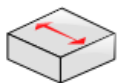

**Hub**

————— **Straight Cable**



**Switch**

----- **Cross-Over Cable**

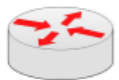

**Router**

⚡ **Serial**



**Internet**

⊕⊕⊕⊕ **Etherchannel**

## IP Address

IP address dipakai untuk pengalamatan dalam jaringan.

- IP Network sebagai identitas network/jaringan. Jika ada IP 192.168.1.0/24 berarti mewakili suatu kelompok IP (network) dari 192.168.1.1 – 192.168.1.254
- IP broadcast merupakan IP terakhir dalam network yang dipakai untuk membroadcast packet broadcast. Misal 192.168.1.255/24.
- Host adalah ip yang disediakan untuk host. Misal: 192.168.1.111/24.

Ada beberapa jenis IP:

- IP public digunakan untuk mengakses internet.
- IP private digunakan untuk jaringan local.

## Ethernet Cable

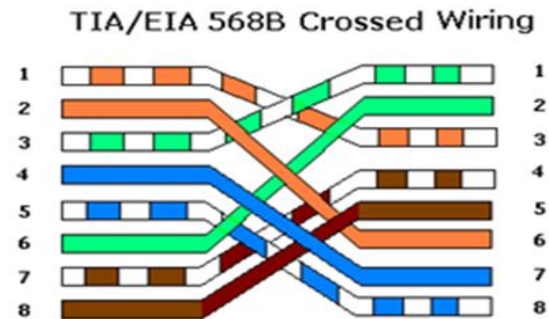
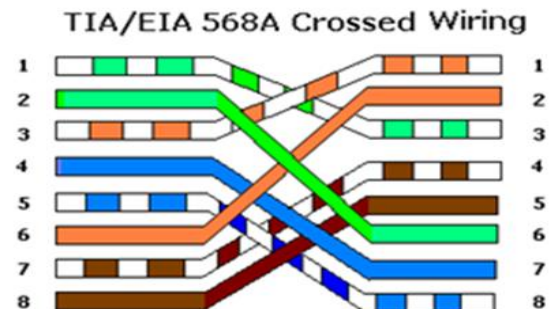

Figure A

*Shows the Pin Out of Straight through Cables*

Figure B

*Shows the Pin Out of Crossover Cables*

# Subnetting so Easy

Subnetting adalah membagi menjadi suatu network menjadi subnetwork yang lebih kecil. Inilah yang disebut subnet. Salah satu aspek dalam suatu design jaringan yang baik adalah pengoptimalan alamat ip. Subnetting meminimalisir alamat ip yang tidak terpakai atau terbuang.

Subnetting juga mempermudah dalam pengelolaan dan kinerja jaringan. Jika subnetting dianalogikan dalam kehidupan nyata, maka akan seperti gambar dibawah. Dengan pengaturan subnetting, maka akan terbentuk seperti gang-gang kecil ke kompleks masing-masing sehingga mudah dalam membedakan jaringan dan pengiriman data ke tujuan.

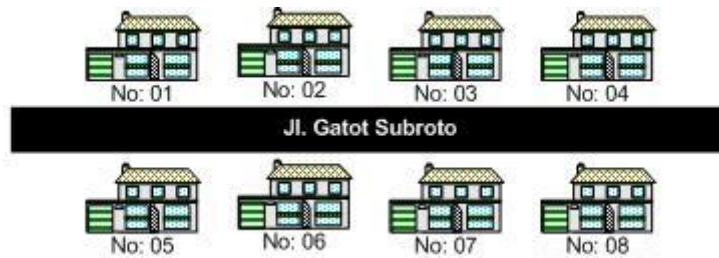

Tanpa Subnet

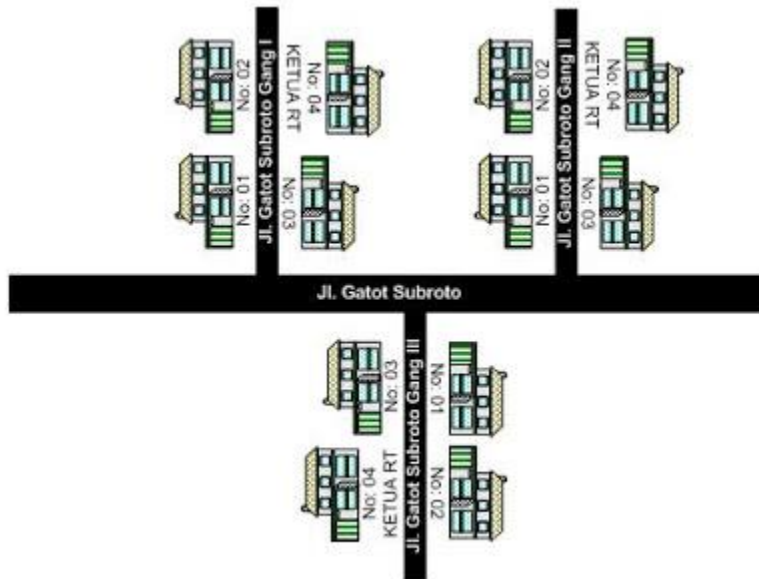

Dengan Subnet

Subnetting ini adalah hal yang wajib dikuasai oleh seorang network engineer. Klo dulu waktu ulangan subnet masih iseng-iseng pake subnet calculator online.

Hehehe... Sekarang harus benar-bener paham. Untuk memahami subnetting ini, terlebih dahulu mengerti tentang bilangan decimal dan biner (nol atau satu).

Dalam subnetting, ada beberapa hal yang paling sering dicari.

## Subnetmask

Misal ada ip 192.168.2.172/26 maka subnetmask atau netmask nya adalah /26 = 11111111.11111111.11111111.11000000. Prefix /26 mengindikasikan biner 1 (Net ID) berjumlah 26 dan sisanya yaitu Host ID berjumlah 6.

Dari 11111111.11111111.11111111.11000000 ini ketika didesimalkan maka didapat subnet mask dari adalah 255.255.255.192.

## Total IP

Total IP ini dihitung dari Host ID. Dari contoh soal, didapat Host ID ada 6bit. Karena IPv4 32bit jadi 32-26 sisa 6. Sehingga maksimal IP didapat  $2^6=64$ .

Rumus menghitung maksimal IP:  $2^{\text{Host ID}}$

## Jumlah Subnet

Jumlah subnet dihitung dari Net ID. Karena Net ID subnet /26 adalah 26 maka Subnet ID nya 2. Loh kok bisa? Karena Net ID 26 dikurangi 24 karena kelas C jadi 2. Intinya klo kelas C dikurangi 24, kelas B dikurangi 16, kelas A dikurangi 8. InshaAllah akan lebih paham dalam pembahasan soal selanjutnya sob. Didapat banyak subnetnya adalah  $2^2=4$  subnet.

Rumus menghitung banyak subnet dengan rumus:  $2^{\text{subnet ID}}$

## Menentukan IP Network dan Broadcast

Karena soalnya IP 192.168.2.172, maka gak mungkin termasuk subnet/network pertama karena  $72 > 64$ . Jadi IP tersebut masuk ke subnet ke berapa ya? Kita hitung aja kelipatan 64. IP Network pasti paling awal dan broadcast paling akhir. Gampangnya ip network setelahnya dikurang 1 itulah broadcast.

	IP Network	Broadcast
1	192.168.2.0	192.168.2.63
2	192.168.2.64	192.168.2.127

3	192.168.2.128	192.168.2.191
4	192.168.2.192	192.168.2.255

Jadi IP 192.168.2.172 masuk dalam subnet ke 3 dengan ip network 192.168.2.128 dan broadcastnya 192.168.2.191.

## IP Client

Dan ini adalah yang paling gampang, yaitu menghitung maksimal ip yang dapat dipakai host. Rumusnya adalah total ip dikurangi 2 karena dipakai untuk network id dan broadcast. Jadi IP Client tiap subnet adalah  $64-2=62$ .

Untuk menghafal subnet lebih cepat, kita dapat memanfaatkan tabel subnet dibawah ini.

	/	Netmask	Block Size	Subnets			Hosts		
				Class A	Class B	Class C	Class A	Class B	Class C
Class A Network	8	255.0.0.0	256	1			16777214		
	9	255.128.0.0	128	2			8388606		
	10	255.192.0.0	64	4			4194302		
	11	255.224.0.0	32	8			2097150		
	12	255.240.0.0	16	16			1048574		
	13	255.248.0.0	8	32			524286		
	14	255.252.0.0	4	64			262142		
	15	255.254.0.0	2	128			131070		
Class B Network	16	255.255.0.0	256	256	1		65534	65534	
	17	255.255.128.0	128	512	2		32766	32766	
	18	255.255.192.0	64	1024	4		16382	16382	
	19	255.255.224.0	32	2048	8		8190	8190	
	20	255.255.240.0	16	4096	16		4094	4094	
	21	255.255.248.0	8	8192	32		2046	2046	
	22	255.255.252.0	4	16384	64		1022	1022	
	23	255.255.254.0	2	32768	128		510	510	
Class C Network	24	255.255.255.0	256	65536	256	1	254	254	254
	25	255.255.255.128	128	131072	512	2	126	126	126
	26	255.255.255.192	64	262144	1024	4	62	62	62
	27	255.255.255.224	32	524288	2048	8	30	30	30
	28	255.255.255.240	16	1048576	4096	16	14	14	14
	29	255.255.255.248	8	2097152	8192	32	6	6	6
	30	255.255.255.252	4	4194304	16384	64	2	2	2

Tabel Subneting

## Contoh Soal Subnetting

Dalam pembahasan ini, kita akan belajar untuk mengerjakan berbagai variasi soal subnetting. Soal subnettingnya sebagai berikut guys.

Carilah total ip, netmask, ip network, broadcast dan host untuk masing-masing ip dibawah:

- 192.168.10.10/25
- 10.10.10.10/13
- 20.20.20.20/23
- 11.12.13.14/20
- 50.50.50.50./15

Ok langsung aja kita bahas bareng dari soal pertama ya...

### IP 192.168.10.10/25 merupakan kelas C

- a. Total IP : 128  
Didapat dari  $2^7 = 128$ , 7 merupakan Host ID dari subnet /25
- b. Netmask : 255.255.255.128  
Didapat dari  $256 - \text{Total IP} = 256 - 128 = 128$  menjadi 255.255.255.128
- c. IP Network : 192.168.10.0  
Jumlah subnet adalah  $2^1$ , 1 adalah Subnet ID. IP 192.168.2.10 masuk dalam subnet ke-1 karena berada dalam range 0-127 sehingga IP Networknya 192.168.10.0
- d. Broadcast : 192.168.10.127  
IP Network setelahnya dikurangi 1 =>  $192.168.10.128 - 1 = 192.168.10.127$
- e. Host : 192.168.10.1 – 192.168.10.126  
Jumlah ip yg dapat dipakai adalah 126 didapat dari  $128 - 2$  karena dipakai untuk IP Network dan broadcast.

## 10.10.10.10./13 merupakan kelas A

a. Total IP : 524288

Subnet 13 merupakan subnet kelas A sehingga untuk memudahkan diubah dulu menjadi subnet kelas C dengan ditambah 8 dua kali menjadi 29. Total host subnet 29 adalah 8. Lalu  $8 \times 256 \times 256$  menjadi 524288. Dikali 256 dua kali karena sebelumnya ditambah 8 dua kali untuk menjadi subnet kelas C.

b. Netmask : 255.248.0.0

Seperti biasa 248 didapat dari 256 – total ip. Karena kelas A ditambah 8 dua kali jadi kelas C maka subnet dimajukan 2 kali dari 255.255.255.248 menjadi 255.248.0.0.

c. IP : 10.8.0.0

Network

Setelah disamakan menjadi kelas C ( $13+8+8=29$ ), maka didapat jumlah subnet /29 adalah  $2^5$ , 5 adalah Subnet ID. Total IP dari subnet /29 adalah 8, maka IP 10.10.10.10 masuk dalam IP Networknya 10.8.0.0.

d. Broadcast : 10.15.255.255

IP Network setelahnya dikurangi 1 =>  $10.16.0.0 - 1 = 10.15.255.255$

e. Host : 10.8.0.1 – 10.15.255.254

Jumlah ip yg dapat dipakai adalah 524286 didapat dari  $524288 - 2$  karena dipakai untuk IP Network dan broadcast.

## 11.12.13.14/20 merupakan kelas B

a. Total IP : 4096

Subnet 20 merupakan subnet kelas B sehingga agar lebih mudah diubah dulu menjadi subnet kelas C dengan ditambah 8 menjadi 28. Total host subnet 28 adalah 16. Lalu  $16 \times 256 = 4096$ . Dikali 256 karena sebelumnya ditambah 8 kali untuk menjadi subnet kelas C.

b. Netmask : 255.255.252.0

252 didapat dari 256 – total ip. Karena kelas B ditambah 8 jadi kelas C maka subnet dimajukan 1 kali dari 255.255.255.252 menjadi 255.255.252.0.



- c. IP : 11.12.0.0  
Network Setelah disamakan menjadi kelas C( $20+8=28$ ), maka didapat jumlah subnet /28 adalah  $2^4$ , 4 adalah Subnet ID. Total IP dari subnet /28 adalah 16, maka IP 11.12.13.14 masuk dalam IP Networknya 11.12.0.0 karena masih dalam rentang 11.12.0.0 – 11.15.255.255.
- d. Broadcast : 11.12.15.255  
IP Network setelahnya dikurangi 1 => 11.16.0.0 – 1 = 11.15.255.255
- e. Host : 11.12.0.1 – 11.12.255.254  
Jumlah ip yg dapat dipakai adalah 4096 didapat dari  $4096 - 2$  karena dipakai untuk IP Network dan broadcast.

## Subnetting Challenge ^\_^

Carilah total ip, netmask, ip network, broadcast dan host untuk masing-masing ip dibawah:

- 172.16.10.111/27
- 99.99.99.99/28
- 100.100.100.100/20
- 111.222.33.44/14
- 8.8.8.8/32

Subnets			
CIDR	Subnet Mask	Addresses	Wildcard
/32	255.255.255.255	1	0.0.0.0
/31	255.255.255.254	2	0.0.0.1
/30	255.255.255.252	4	0.0.0.3
/29	255.255.255.248	8	0.0.0.7
/28	255.255.255.240	16	0.0.0.15
/27	255.255.255.224	32	0.0.0.31
/26	255.255.255.192	64	0.0.0.63
/25	255.255.255.128	128	0.0.0.127
/24	255.255.255.0	256	0.0.0.255
/23	255.255.254.0	512	0.0.1.255
/22	255.255.252.0	1,024	0.0.3.255
/21	255.255.248.0	2,048	0.0.7.255
/20	255.255.240.0	4,096	0.0.15.255
/19	255.255.224.0	8,192	0.0.31.255
/18	255.255.192.0	16,384	0.0.63.255
/17	255.255.128.0	32,768	0.0.127.255
/16	255.255.0.0	65,536	0.0.255.255
/15	255.254.0.0	131,072	0.1.255.255
/14	255.252.0.0	262,144	0.3.255.255
/13	255.248.0.0	524,288	0.7.255.255
/12	255.240.0.0	1,048,576	0.15.255.255
/11	255.224.0.0	2,097,152	0.31.255.255
/10	255.192.0.0	4,194,304	0.63.255.255
/9	255.128.0.0	8,388,608	0.127.255.255
/8	255.0.0.0	16,777,216	0.255.255.255
/7	254.0.0.0	33,554,432	1.255.255.255
/6	252.0.0.0	67,108,864	3.255.255.255
/5	248.0.0.0	134,217,728	7.255.255.255
/4	240.0.0.0	268,435,456	15.255.255.255
/3	224.0.0.0	536,870,912	31.255.255.255
/2	192.0.0.0	1,073,741,824	63.255.255.255
/1	128.0.0.0	2,147,483,648	127.255.255.255
/0	0.0.0.0	4,294,967,296	255.255.255.255

Decimal to Binary			
Subnet Mask	Wildcard		
<b>255</b>	1111	1111	<b>0</b> 0000 0000
<b>254</b>	1111	1110	<b>1</b> 0000 0001
<b>252</b>	1111	1100	<b>3</b> 0000 0011
<b>248</b>	1111	1000	<b>7</b> 0000 0111
<b>240</b>	1111	0000	<b>15</b> 0000 1111
<b>224</b>	1110	0000	<b>31</b> 0001 1111
<b>192</b>	1100	0000	<b>63</b> 0011 1111
<b>128</b>	1000	0000	<b>127</b> 0111 1111
<b>0</b>	0000	0000	<b>255</b> 1111 1111

### Subnet Proportion

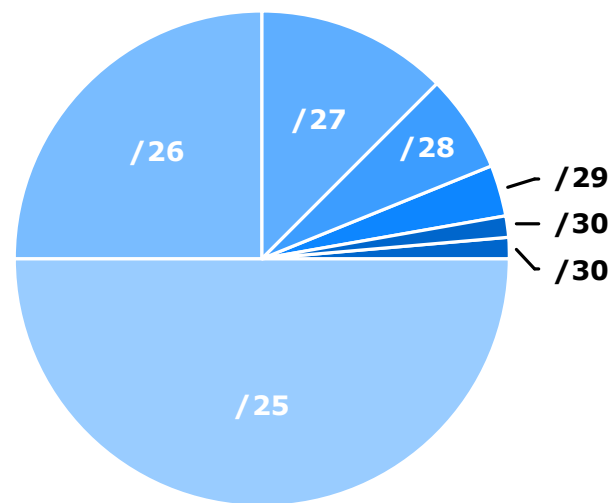

### Classful Ranges

- A** 0.0.0.0 – 127.255.255.255
- B** 128.0.0.0 - 191.255.255.255
- C** 192.0.0.0 - 223.255.255.255
- D** 224.0.0.0 - 239.255.255.255
- E** 240.0.0.0 - 255.255.255.255

### Reserved Ranges

- RFC 1918** 10.0.0.0 - 10.255.255.255
- Localhost** 127.0.0.0 - 127.255.255.255
- RFC 1918** 172.16.0.0 - 172.31.255.255
- RFC 1918** 192.168.0.0 - 192.168.255.255

### Terminology

**CIDR**  
Classless interdomain routing was developed to provide more granularity than legacy classful addressing; CIDR notation is expressed as /XX

**VLSM**  
Variable-length subnet masks are an arbitrary length between 0 and 32 bits; CIDR relies on VLSMs to define routes

## Broadcast Domain dan Collision Domain

Collision domain adalah area dalam suatu jaringan dimana packet data dapat mengalami tabrakan (collision) dikarenakan device mengirimnya pada waktu yang bersamaan. Pada Hub, collision domainnya menjadi 1 (besar) dan pada Switch dan Router, collision domain hanya terjadi pada masing-masing interface.

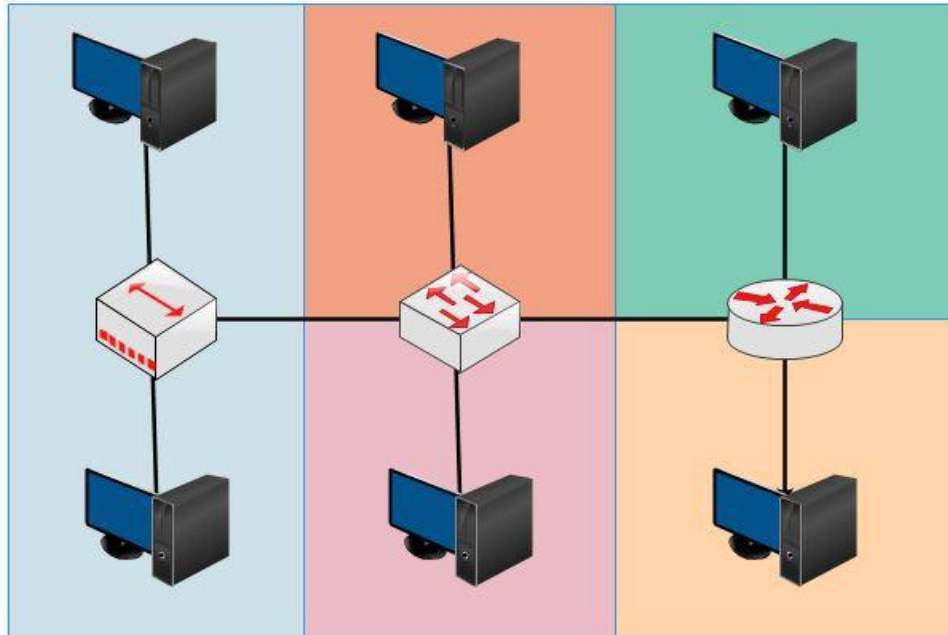

Broadcast domain adalah area dalam suatu jaringan dimana broadcast diforward pada pertama kali. Hub dan Switch mempunyai broadcast domain yang sama karena sama-sama melewati broadcast, sedang Router tidak melewati broadcast.

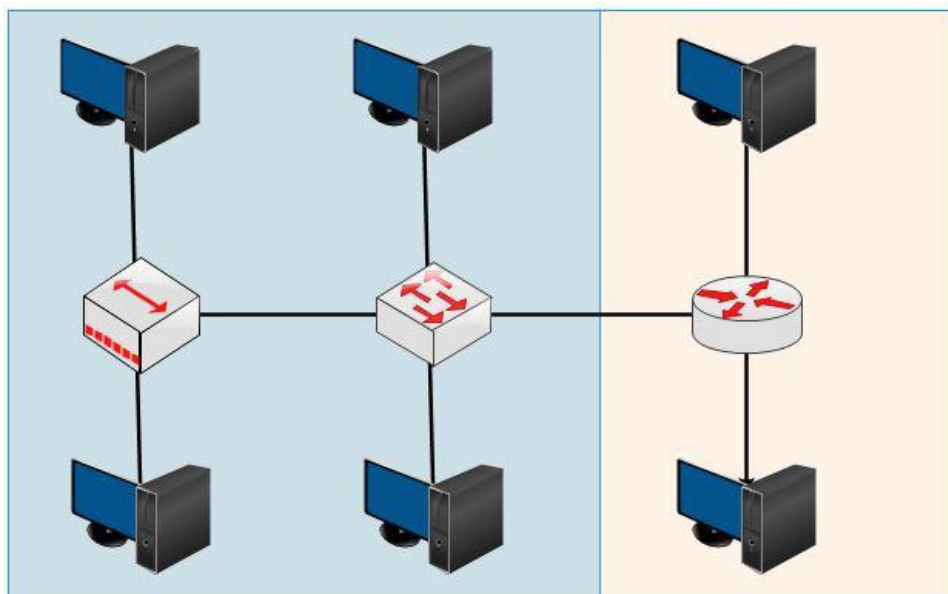

## Perbedaan Hub, Bridge, Switch dan Router

Hub gak lebih dari physical repeater yang bekerja pada layer 1 dan gak punya inteligensi. Cara kerja hub adalah dengan menerima sinyal electric dari satu interface dan mengirimkannya ke semua interface kecuali ke source interface, butuh atau gak butuh.

Karena bekerja pada layer physical dengan half-duplex (satu mengirim, yang lain menunggu), maka dapat terjadi tabrakan (collision) ketika ada packet yang dikirimkan dalam waktu yang bersamaan. Area dimana dapat terjadi collision disebut dengan collision domain.

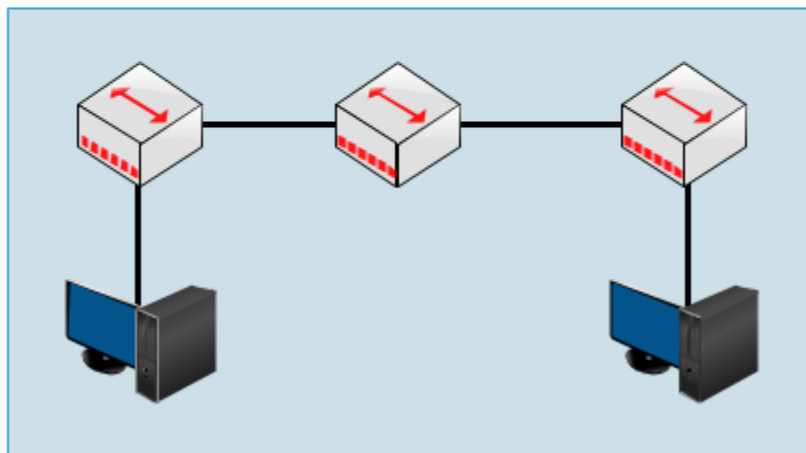
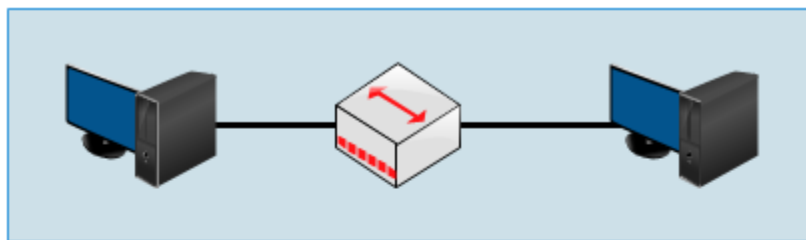

Kedua topologi diatas merupakan single collision domain. Semakin besar jaringan seperti diatas, collision juga semakin besar, dan menurunkan kinerja jaringan (down).

### Terus apa solusinya?

Mengganti dengan perangkat yang bekerja pada layer 2 (data link) dan mempunyai inteligensi yaitu bridge. Karakteristik bridge:

- Memutuskan kemana Ethernet frame dikirim dengan melihat MAC Address.
- Forward Ethernet frame hanya ke port yang membutuhkan.
- Filter Ethernet frames (discard them).

- Flood Ethernet frames (send them everywhere).
- Hanya punya beberapa port.
- Slow.

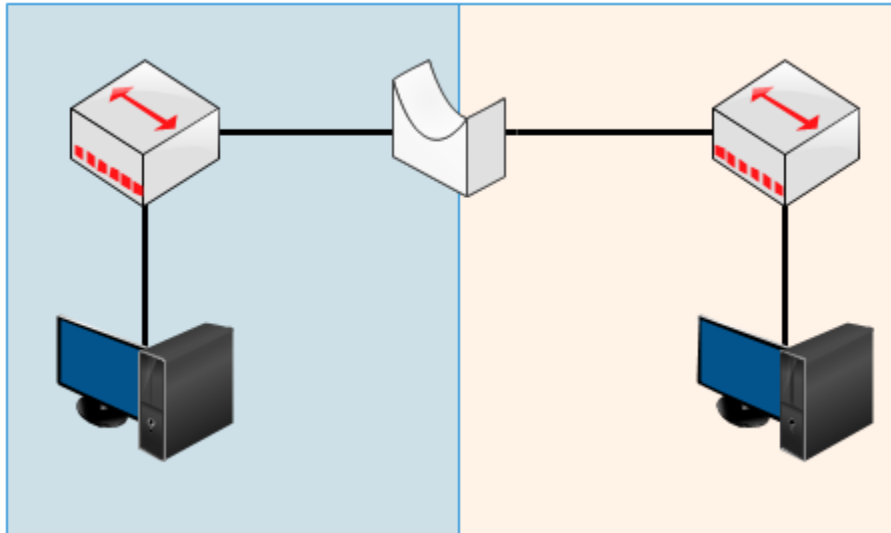

Dengan begitu collision domain terbagi menjadi 2 pada topologi diatas. Tapi sekarang kita gak pake hub atau bridge karena udah ada switch.

Bridge kembar sama switch... tapi gak sama...

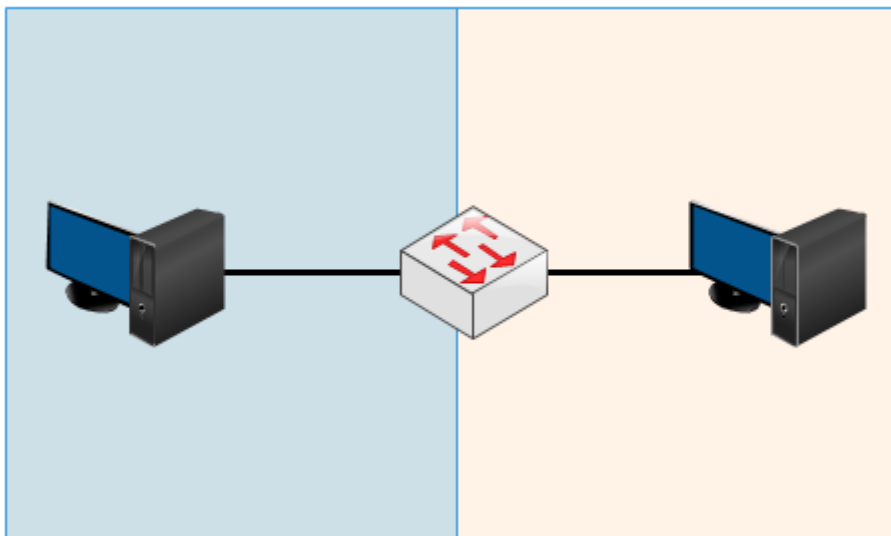

Switch adalah bridge dengan beberapa kelebihan.

- Mempunyai banyak port.
- Mempunyai macam-macam port seperti FastEthernet dan Gigabit.
- Fast internet switching.

– Large buffers.

## Cara kerja switch

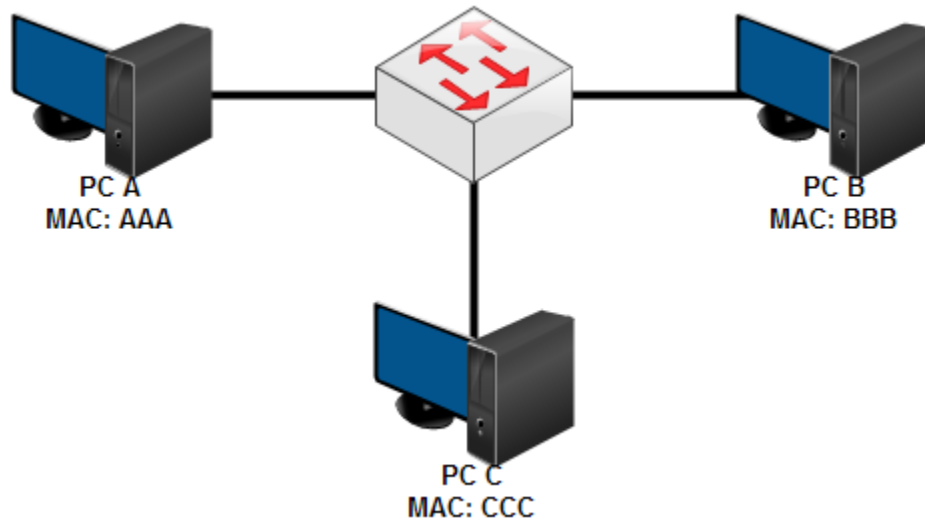

Switch mempunyai tabel MAC Address yang menyimpan MAC Address dari PC yang tersambung ke port-port pada switch. Misal ketika pertama kali ketika PC disambungkan ke switch, PC A ingin mengirimkan data ke C.

–Maka PC A membuat Ethernet frame berisi IP address, MAC address dan tujuannya dan mengirimkannya ke switch.

– switch lalu membroadcastnya ke semua port kecuali source. Sampai sini, switch telah menyimpan MAC address A.

– Setelah dibroadcast, PC C akan mengirim reply berisi MAC addressnya dan ketika lewat switch, switch akan menyimpan MAC address C.

Broadcast dikirim ketika ada packet data yang destination MAC addressnya gak ada pada tabel MAC address switch.

Okey... to the point...

Hub kerja pada layer 1 – Physical

Bridge sama switch kerja di layer 2 – Data Link

Klo router? beda lagi,, kerjanya dilayer 3 – Network

Hub, Bridge sm Switch melewati broadcast... Klo router enggak...

## Optical Terminations



**ST (Straight Tip)**



**SC (Subscriber Connector)**



**LC (Local Connector)**



**MT-RJ**

## Wireless Antennas



**RP-TNC**



**RP-SMA**



**RJ-45**



**RJ-11**



**RJ-21 (25-pair)**



**DE-9 (Female)**



**DB-25 (Male)**



**DB-60 (Male)**

## GBICs



**1000Base-SX/LX**



**1000Base-T**



**Cisco GigaStack**



**1000Base-SX/LX SFP**



**1000Base-T SFP**



**X2 (10Gig)**

## TCP/UDP Port Numbers

7	Echo	554	RTSP	2745	Bagle.H	6891-6901	Windows Live
19	Chargen	546-547	DHCPv6	2967	Symantec AV	6970	Quicktime
20-21	FTP	560	rmonitor	3050	Interbase DB	7212	GhostSurf
22	SSH/SCP	563	NNTP over SSL	3074	XBOX Live	7648-7649	CU-SeeMe
23	Telnet	587	SMTP	3124	HTTP Proxy	8000	Internet Radio
25	SMTP	591	FileMaker	3127	MyDoom	8080	HTTP Proxy
42	WINS Replication	593	Microsoft DCOM	3128	HTTP Proxy	8086-8087	Kaspersky AV
43	WHOIS	631	Internet Printing	3222	GLBP	8118	Privoxy
49	TACACS	636	LDAP over SSL	3260	iSCSI Target	8200	VMware Server
53	DNS	639	MSDP (PIM)	3306	MySQL	8500	Adobe ColdFusion
67-68	DHCP/BOOTP	646	LDP (MPLS)	3389	Terminal Server	8767	TeamSpeak
69	TFTP	691	MS Exchange	3689	iTunes	8866	Bagle.B
70	Gopher	860	iSCSI	3690	Subversion	9100	HP JetDirect
79	Finger	873	rsync	3724	World of Warcraft	9101-9103	Bacula
80	HTTP	902	VMware Server	3784-3785	Ventrilo	9119	MXit
88	Kerberos	989-990	FTP over SSL	4333	mSQL	9800	WebDAV
102	MS Exchange	993	IMAP4 over SSL	4444	Blaster	9898	Dabber
110	POP3	995	POP3 over SSL	4664	Google Desktop	9988	Rbot/Spybot
113	Ident	1025	Microsoft RPC	4672	eMule	9999	Urchin
119	NNTP (Usenet)	1026-1029	Windows Messenger	4899	Radmin	10000	Webmin
123	NTP	1080	SOCKS Proxy	5000	UPnP	10000	BackupExec
135	Microsoft RPC	1080	MyDoom	5001	Slingbox	10113-10116	NetIQ
137-139	NetBIOS	1194	OpenVPN	5001	iperf	11371	OpenPGP
143	IMAP4	1214	Kazaa	5004-5005	RTP	12035-12036	Second Life
161-162	SNMP	1241	Nessus	5050	Yahoo! Messenger	12345	NetBus
177	XDMCP	1311	Dell OpenManage	5060	SIP	13720-13721	NetBackup
179	BGP	1337	WASTE	5190	AIM/ICQ	14567	Battlefield
201	AppleTalk	1433-1434	Microsoft SQL	5222-5223	XMPP/Jabber	15118	Dipnet/Oddbob
264	BGMP	1512	WINS	5432	PostgreSQL	19226	AdminSecure
318	TSP	1589	Cisco VQP	5500	VNC Server	19638	Ensim
381-383	HP Openview	1701	L2TP	5554	Sasser	20000	Usermin
389	LDAP	1723	MS PPTP	5631-5632	pcAnywhere	24800	Synergy
411-412	Direct Connect	1725	Steam	5800	VNC over HTTP	25999	Xfire
443	HTTP over SSL	1741	CiscoWorks 2000	5900+	VNC Server	27015	Half-Life
445	Microsoft DS	1755	MS Media Server	6000-6001	X11	27374	Sub7
464	Kerberos	1812-1813	RADIUS	6112	Battle.net	28960	Call of Duty
465	SMTP over SSL	1863	MSN	6129	DameWare	31337	Back Orifice
497	Retrospect	1985	Cisco HSRP	6257	WinMX	33434+	traceroute
500	ISAKMP	2000	Cisco SCCP	6346-6347	Gnutella		
512	rexec	2002	Cisco ACS	6500	GameSpy Arcade		
513	rlogin	2049	NFS	6566	SANE		
514	syslog	2082-2083	cPanel	6588	AnalogX		
515	LPD/LPR	2100	Oracle XDB	6665-6669	IRC		
520	RIP	2222	DirectAdmin	6679/6697	IRC over SSL		
521	RIPng (IPv6)	2302	Halo	6699	Napster		
540	UUCP	2483-2484	Oracle DB	6881-6999	BitTorrent		

## Legend

<span style="background-color: #e06699; width: 15px; height: 10px; display: inline-block;"></span>	Chat
<span style="background-color: #4a86e8; width: 15px; height: 10px; display: inline-block;"></span>	Encrypted
<span style="background-color: #4caf50; width: 15px; height: 10px; display: inline-block;"></span>	Gaming
<span style="background-color: #d32f2f; width: 15px; height: 10px; display: inline-block;"></span>	Malicious
<span style="background-color: #ffb74d; width: 15px; height: 10px; display: inline-block;"></span>	Peer to Peer
<span style="background-color: #fff9c4; width: 15px; height: 10px; display: inline-block;"></span>	Streaming

IANA port assignments published at <http://www.iana.org/assignments/port-numbers>



# SWITCHING

Perintah Dasar Switch & Router Cisco  
Konfigurasi Password pada Cisco  
Virtual LAN (VLAN)  
Trunking VLAN  
Inter-VLAN - Router on a Stick  
Inter-VLAN – Switch Layer 3  
DHCP menggunakan Switch  
Port Security  
Spanning Tree Protocol (STP)  
STP Portfast  
Etherchannel  
VLAN Trunking Protocol (VTP)

## Cisco Devices Overview

Switch pada cisco biasa disebut catalyst. Perbedaan switch dan router yang paling menonjol adalah switch mempunyai banyak port.



Catalyst 1900 Series



Cisco Catalyst 2690 Series



Cisco Router 2900 series

## Perintah Dasar Switch & Router Cisco

Ada beberapa perintah dasar cisco yang wajib diketahui.

```
Router>
Router>enable
Router#
Router#configure terminal
Router(config)#
```

Ada beberapa hak akses ketika masuk dalam Cisco IOS:

- *User mode* ditandai dengan tanda ">"
- *Privilege mode* ditandai dengan tanda "#". Untuk masuk dari user mode ke privilege mode ketikkan perintah *enable*.
- *Global configuration mode* digunakan untuk mengkonfigurasi perangkat.

## Mengganti Hostname

```
Router(config)#hostname Semarang  
Semarang (config)#
```

## Meyimpan Konfigurasi

Konfigurasi agar ketika device direboot konfigurasi tidak hilang.

```
Router(config)#write
```

atau

```
Router(config)#copy run start
```

## Merest Perangkat Cisco

Untuk mengembalikan konfigurasi ke default.

```
Router(config)#write erase
```

Perintah `show ip interface brief` digunakan untuk melihat informasi interface.

```
R1#show ip interface brief  
Interface                IP-Address      OK? Method Status      Protocol  
FastEthernet0/0          10.10.10.1      YES manual  up          up  
FastEthernet0/1          12.12.12.1      YES manual  up          up  
Loopback0                 1.1.1.1         YES manual  up          up  
Vlan1                     unassigned      YES unset   administratively down down  
R1#
```

Perintah `show running-config` digunakan untuk melihat konfigurasi yang sedang berjalan.

```
R1#show running-config  
Building configuration...  
  
Current configuration : 687 bytes  
!  
version 12.4  
no service timestamps log datetime msec  
no service timestamps debug datetime msec  
no service password-encryption  
!  
hostname R1  
!  
spanning-tree mode pvst  
!  
interface Loopback0
```

```

ip address 1.1.1.1 255.255.255.255
!
interface FastEthernet0/0
ip address 10.10.10.1 255.255.255.0
ip nat inside
duplex auto
speed auto
!
interface FastEthernet0/1
ip address 12.12.12.1 255.255.255.0
ip nat outside
duplex auto
speed auto
!
interface Vlan1
no ip address
shutdown
!
ip nat inside source static 10.10.10.2 12.12.12.12
ip classless
ip route 0.0.0.0 0.0.0.0 12.12.12.2
!
line con 0
!
line aux 0
!
line vty 0 4
login
!
+
end

```

## Konfigurasi Password pada Cisco

Keamanan adalah hal yang penting dalam suatu jaringan. Pemberian autentikasi berupa username dan password dalam device dilakukan agar tidak sembarang orang dapat masuk ke device.

Mengeset Password Line Console maka ketika melakukan config melalui port console akan diminta login.

```

Router>enable
Router#configure terminal
Router(config)#line console 0
Router(config-line)#password 123
Router(config-line)#login

```

Ketika masuk ke device akan muncul tampilan berikut.

```

User Access Verification

Password:

```

Konfigurasi VTY (Virtual Terminal) agar device dapat ditelnet dengan menggunakan username dan password yang spesifik.

```
Router(config)#username admin
Router(config)#enable password cobal
Router(config)#enable secret coba2
```

Ketika di *show run*.

```
Router#sh run
Building configuration...

Current configuration : 598 bytes
!
version 12.4
no service timestamps log datetime msec
no service timestamps debug datetime msec
no service password-encryption
!
hostname Router
!
enable secret 5 $1$mERr$9SLt1DbYs.aoemVq5cCcc.
enable password cobal
!
username admin
```

enable secret = password dienkripsi.

enable password = password tidak dienkripsi dan dapat dilihat dengan show run.

Jika kita mengeset enable secret dan enable password, maka yang dipakai adalah enable secret.

## Virtual LAN (VLAN)

Virtual LAN (VLAN) membagi satu broadcast domain menjadi beberapa broadcast domain, sehingga dalam satu switch bisa saja terdiri dari beberapa network. Host yang berbeda VLAN tidak akan tersambung sehingga meningkatkan security jaringan.

VLAN adalah fasilitas yang dimiliki oleh switch manageable, contohnya cisco. Pada switch unmanageable, port-port nya hanya dapat digunakan untuk koneksi ke network yang sama (satu network) sehingga tidak mendukung fasilitas VLAN.

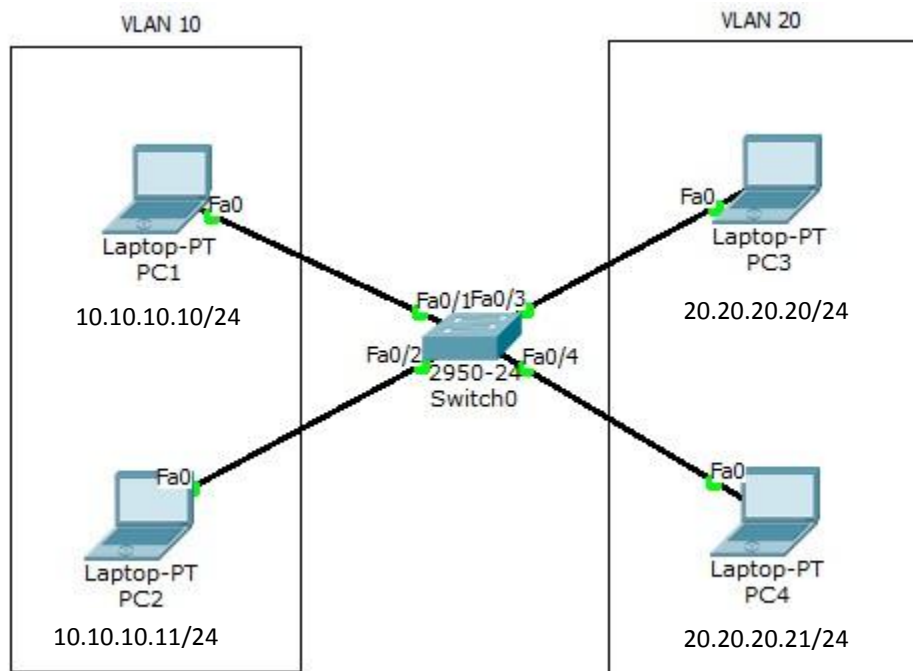

Buatlah topologi seperti pada gambar diatas pada packet tracer. Konfigurasi VLAN pada switch dengan VLAN10 berikan nama Marketing dan VLAN20 dengan nama Sales.

```
Switch>enable
Switch#conf t
Switch(config)#vlan 10
Switch(config-vlan)#name Marketing
Switch(config-vlan)#vlan 20
Switch(config-vlan)#name Sales
Switch(config-vlan)#int f0/1
Switch(config-if)#switchport access vlan 10
Switch(config-if)#int f0/2
Switch(config-if)#switchport access vlan 10
Switch(config-if)#int f0/3
Switch(config-if)#switchport access vlan 20
Switch(config-if)#int f0/4
Switch(config-if)#switchport access vlan 20
```

Untuk pengecekan, ping dari satu PC ke PC lain dan ketikkan perintah show vlan pada switch. PC tidak bisa ping ke beda VLAN.

```

PC>ping 10.10.10.11

Pinging 10.10.10.11 with 32 bytes of data:

Reply from 10.10.10.11: bytes=32 time=0ms TTL=128
Reply from 10.10.10.11: bytes=32 time=0ms TTL=128
Reply from 10.10.10.11: bytes=32 time=0ms TTL=128
Reply from 10.10.10.11: bytes=32 time=0ms TTL=128

Ping statistics for 10.10.10.11:
    Packets: Sent = 4, Received = 4, Lost = 0 (0% loss),
Approximate round trip times in milli-seconds:
    Minimum = 0ms, Maximum = 0ms, Average = 0ms

PC>ping 20.20.20.21

Pinging 20.20.20.21 with 32 bytes of data:

Request timed out.
Request timed out.
Request timed out.
Request timed out.

Ping statistics for 20.20.20.21:
    Packets: Sent = 4, Received = 0, Lost = 4 (100% loss),

PC>

```

```

Switch#show vlan
VLAN Name                Status    Ports
-----
---
1    default                active    Fa0/5, Fa0/6, Fa0/7, Fa0/8
Fa0/9, Fa0/10, Fa0/11,
Fa0/12
Fa0/13, Fa0/14, Fa0/15,
Fa0/16
Fa0/17, Fa0/18, Fa0/19,
Fa0/20
Fa0/21, Fa0/22, Fa0/23,
Fa0/24
10  VLAN0010                active    Fa0/1, Fa0/2
20  VLAN0020                active    Fa0/3, Fa0/4
1002 fddi-default            act/unsup
1003 token-ring-default    act/unsup
1004 fddinet-default        act/unsup
1005 trnet-default         act/unsup

VLAN Type  SAID          MTU   Parent RingNo BridgeNo Stp  BrdgMode Trans1 Trans2
-----
--
1    enet  100001       1500  -     -     -     -   -       0       0

```

```

10 enet 100010 1500 - - - - - 0 0
20 enet 100020 1500 - - - - - 0 0
1002 fddi 101002 1500 - - - - - 0 0
1003 tr 101003 1500 - - - - - 0 0
1004 fdnet 101004 1500 - - - - ieee 0 0
1005 trnet 101005 1500 - - - - ibm 0 0

```

Remote SPAN VLANs

--

```

Primary Secondary Type Ports
-----

```

--

## Trunking VLAN

Trunking berfungsi melewatkan traffic VLAN dari switch yang berbeda. Antara switch lantai 1 dan lantai 2 terhubung. PC1, PC2, PC5 dan PC6 masuk dalam VLAN 10 sedang PC3, PC4, PC7 dan PC8 masuk dalam VLAN 20.

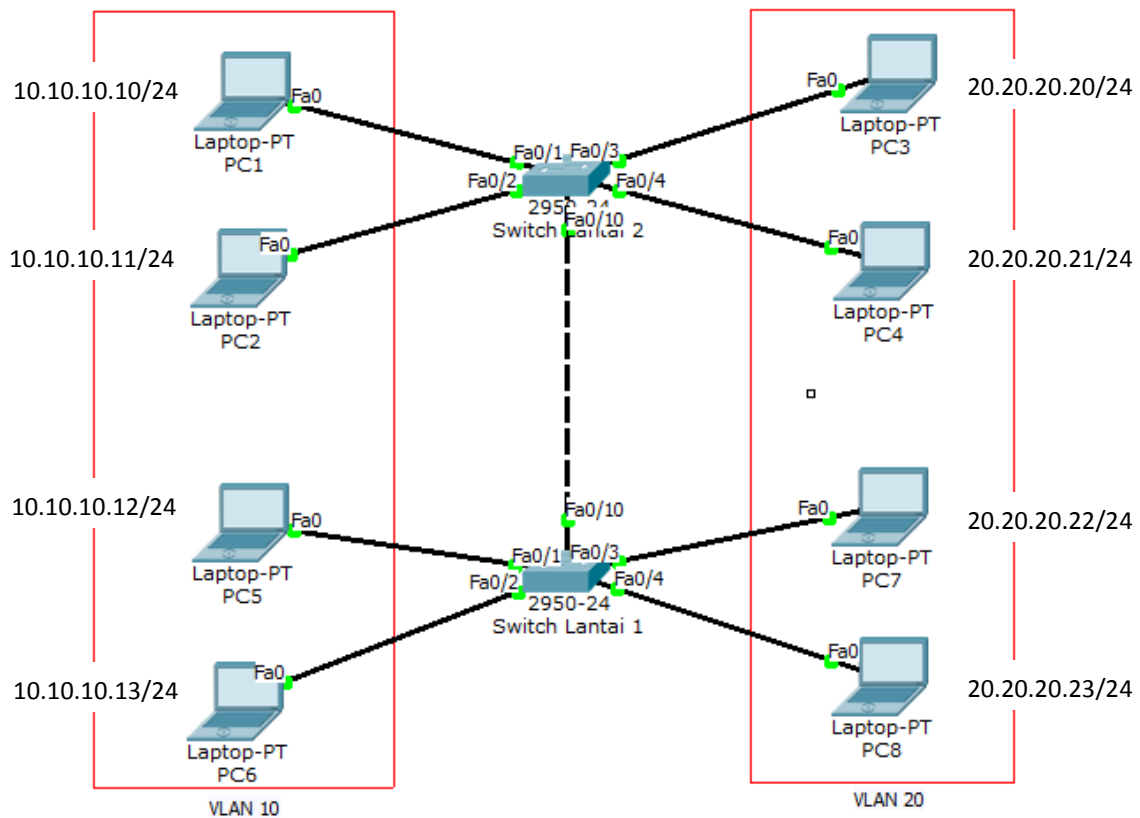

Konfigurasi VLAN pada seperti dibawah. Membuat vlan 10 dan vlan 20.



```
switch1(config)#vlan 10
switch1(config-vlan)#vlan 20
switch1(config-vlan)#int f0/1
switch1(config-if)#sw access vlan 10
switch1(config-if)#int f0/2
switch1(config-if)#sw access vlan 10
switch1(config-vlan)#int f0/3
switch1(config-if)#sw access vlan 10
switch1(config-vlan)#int f0/4
switch1(config-if)#sw access vlan 10
```

```
Switch0(config)#vlan 10
Switch0(config-vlan)#vlan 20
Switch0(config-vlan)#int f0/1
Switch0(config-if)#sw access vlan 10
Switch0(config-if)#int f0/2
Switch0(config-if)#sw access vlan 10
Switch0(config-vlan)#int f0/3
Switch0(config-if)#sw access vlan 10
Switch0(config-vlan)#int f0/4
Switch0(config-if)#sw access vlan 10
```

**Konfigurasi interface yang saling terhubung antar switch dengan mode trunk. Lakukan pada kedua switch.**

```
Switch0(config)#int f0/10
Switch0(config-if)#switchport mode trunk
Switch1(config)#int f0/10
Switch1(config-if)#switchport mode trunk
```

**Ping dari satu PC ke PC lain dan ketikkan perintah show vlan.**

```
PC>ping 10.10.10.11

Pinging 10.10.10.11 with 32 bytes of data:

Reply from 10.10.10.11: bytes=32 time=17ms TTL=128
Reply from 10.10.10.11: bytes=32 time=0ms TTL=128
Reply from 10.10.10.11: bytes=32 time=0ms TTL=128
Reply from 10.10.10.11: bytes=32 time=0ms TTL=128

Ping statistics for 10.10.10.11:
    Packets: Sent = 4, Received = 4, Lost = 0 (0% loss),
    Approximate round trip times in milli-seconds:
        Minimum = 0ms, Maximum = 17ms, Average = 4ms

PC>ping 10.10.10.13

Pinging 10.10.10.13 with 32 bytes of data:

Reply from 10.10.10.13: bytes=32 time=11ms TTL=128
Reply from 10.10.10.13: bytes=32 time=0ms TTL=128
Reply from 10.10.10.13: bytes=32 time=0ms TTL=128
Reply from 10.10.10.13: bytes=32 time=1ms TTL=128

Ping statistics for 10.10.10.13:
```

```

Packets: Sent = 4, Received = 4, Lost = 0 (0% loss),
Approximate round trip times in milli-seconds:
  Minimum = 0ms, Maximum = 11ms, Average = 3ms

PC>ping 20.20.20.20

Pinging 20.20.20.20 with 32 bytes of data:

Request timed out.
Request timed out.
Request timed out.
Request timed out.

Ping statistics for 20.20.20.20:
    Packets: Sent = 4, Received = 0, Lost = 4 (100% loss),

PC>

```

PC dapat melakukan ping ke sesama VLAN beda switch namun tidak bisa ke beda VLAN.

```

Switch1#sh int trunk
Port      Mode           Encapsulation  Status        Native vlan
Fa0/10    on             802.1q         trunking      1

Port      Vlans allowed on trunk
Fa0/10    1-1005

Port      Vlans allowed and active in management domain
Fa0/10    1,10,20

Port      Vlans in spanning tree forwarding state and not pruned
Fa0/10    1,10,20

```

## Inter-VLAN - Router on a Stick

Untuk menghubungkan VLAN yang berbeda, dibutuhkan perangkat layer 3 baik itu router atau switch layer 3. Cara pertama adalah dengan menggunakan satu router melalui satu interface. Teknik ini disebut router on a stick. Kekurangan dari teknik ini adalah akan terjadi collision domain karena hanya menggunakan satu interface.

Ada 2 trunking protocol yang biasa digunakan:

- ISL = cisco proprietary, bekerja pada ethernet, token ring dan FDDI, menambah tag sebesar 30byte pada frame dan semua traffic VLAN ditag.
- IEEE 802.11Q (dot1q) = open standard, hanya bekerja pada ethernet, menambah tag sebesar 4byte pada frame.

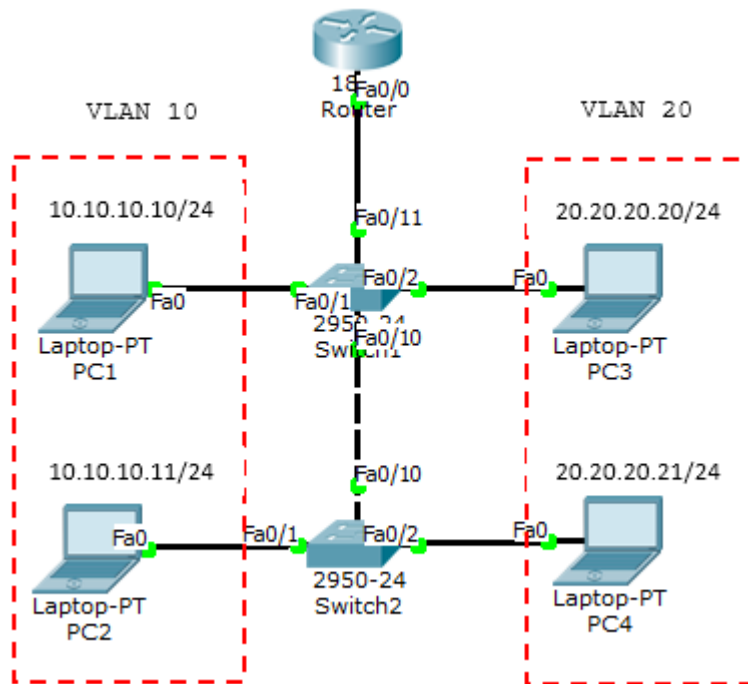

Buat topologi seperti diatas dan konfigurasi VLAN10 dan VLAN20 seperti lab sebelumnya. Tambahkan 1 router. Karena hanya menggunakan 1 interface, maka harus dibuat sub-interface untuk dijadikan gateway VLAN. Port SW1 yang terhubung ke router harus diset mode trunk.

```
Router(config)#interface FastEthernet0/0.10
Router(config-subif)#encapsulation dot1Q 10
Router(config-subif)#ip address 10.10.10.1 255.255.255.0
Router(config-subif)#interface FastEthernet0/0.20
Router(config-subif)#encapsulation dot1Q 20
Router(config-subif)#ip address 20.20.20.1 255.255.255.0
```

Cek interface dengan perintah *show ip int brief*.

```
Router#sh ip int br
Interface                IP-Address      OK? Method Status
Protocol
FastEthernet0/0          unassigned      YES unset  up
FastEthernet0/0.10      10.10.10.1     YES manual  up
FastEthernet0/0.20      20.20.20.1     YES manual  up
FastEthernet0/0.30      30.30.30.30    YES manual  up
FastEthernet0/1          unassigned      YES unset  administratively down down
Vlan1                    unassigned      YES unset  administratively down down
Router#
```

Sekarang ping antar VLAN yang berbeda.

```

PC>ping 20.20.20.21

Pinging 20.20.20.21 with 32 bytes of data:

Request timed out.
Reply from 20.20.20.21: bytes=32 time=1ms TTL=127
Reply from 20.20.20.21: bytes=32 time=0ms TTL=127
Reply from 20.20.20.21: bytes=32 time=0ms TTL=127

Ping statistics for 20.20.20.21:
    Packets: Sent = 4, Received = 3, Lost = 1 (25% loss),
    Approximate round trip times in milli-seconds:
        Minimum = 0ms, Maximum = 1ms, Average = 0ms

PC>tracert 20.20.20.21

Tracing route to 20.20.20.21 over a maximum of 30 hops:

  0  30 ms    0 ms     0 ms     10.10.10.1
  1  0 ms     0 ms     0 ms     20.20.20.21

Trace complete.

```

```

Router#sh ip arp
Protocol Address           Age (min)  Hardware Addr   Type   Interface
-----
Internet 10.10.10.10        4          0000.0C1B.0D20  ARPA
FastEthernet0/0.10
Internet 20.20.20.21        3          0060.7092.05A9  ARPA
FastEthernet0/0.20
Internet 30.30.30.1         1          0001.C7AE.3D52  ARPA
FastEthernet0/0.30
Router#

```

## Inter-VLAN – Switch Layer 3

Untuk menghubungkan antar VLAN dibutuhkan suatu perangkat layer 3 baik itu router atau switch layer 3. Kalau sebelum menggunakan router on a stick, kali ini kita akan menggunakan switch L3 (layer 3). Inilah kerennya cisco, kalo switch yang lain bekerja pada layer 2, switch cisco dapat bekerja pada layer 3 dan menjalankan routing. Namun, meski untuk routing yang lebih luas lebih dianjurkan menggunakan router sesuai fungsinya.

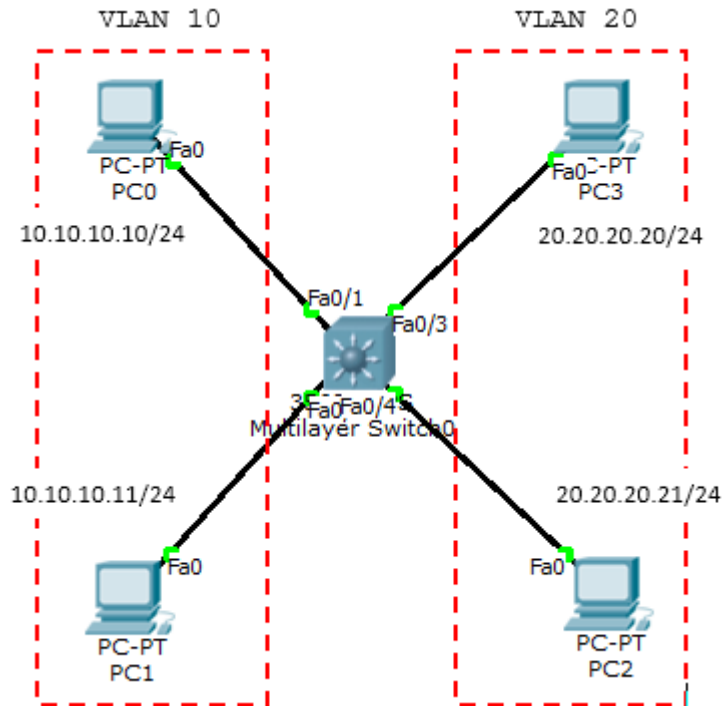

Konfigurasi port ke VLANnya masing-masing.

```
Switch(config)#interface FastEthernet0/1
Switch(config-if)#switchport access vlan 10
Switch(config-if)#switchport mode access
Switch(config-if)#
Switch(config-if)#interface FastEthernet0/2
Switch(config-if)#switchport access vlan 10
Switch(config-if)#switchport mode access
Switch(config-if)#
Switch(config-if)#interface FastEthernet0/3
Switch(config-if)#switchport access vlan 20
Switch(config-if)#switchport mode access
Switch(config-if)#interface FastEthernet0/4
Switch(config-if)#switchport access vlan 20
Switch(config-if)#switchport mode access
```

Buat interface VLAN dan beri ip address.

```
Switch(config)#int vlan 10
Switch(config-if)#ip add 10.10.10.1 255.255.255.0
Switch(config-if)#int vlan 20
Switch(config-if)#ip add 20.20.20.1 255.255.255.0
```

Ketiikkan perintah ip routing untuk merouting VLAN.

```
Switch(config)#ip routing
```

Sekarang tes ping.

```
PC>ping 20.20.20.21
```

```
Pinging 20.20.20.21 with 32 bytes of data:
```

```
Request timed out.  
Reply from 20.20.20.21: bytes=32 time=0ms TTL=127  
Reply from 20.20.20.21: bytes=32 time=0ms TTL=127  
Reply from 20.20.20.21: bytes=32 time=0ms TTL=127  
  
Ping statistics for 20.20.20.21:  
    Packets: Sent = 4, Received = 3, Lost = 1 (25% loss),  
Approximate round trip times in milli-seconds:  
    Minimum = 0ms, Maximum = 0ms, Average = 0ms  
  
PC>
```

## Trunk Encapsulation

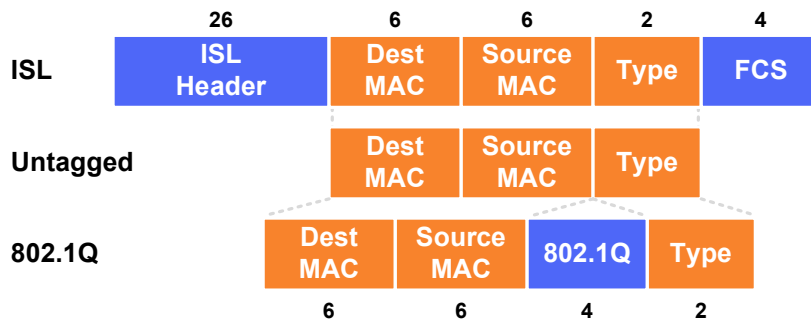

## VLAN Creation

```
Switch(config)# vlan 100
Switch(config-vlan)# name Engineering
```

## Access Port Configuration

```
Switch(config-if)# switchport mode access
Switch(config-if)# switchport nonegotiate
Switch(config-if)# switchport access vlan 100
Switch(config-if)# switchport voice vlan 150
```

## Trunk Port Configuration

```
Switch(config-if)# switchport mode trunk
Switch(config-if)# switchport trunk encapsulation dot1q
Switch(config-if)# switchport trunk allowed vlan 10,20-30
Switch(config-if)# switchport trunk native vlan 10
```

## SVI Configuration

```
Switch(config)# interface vlan100
Switch(config-if)# ip address 192.168.100.1 255.255.255.0
```

## VLAN Trunking Protocol (VTP)

### Domain

Common to all switches participating in VTP

### Server Mode

Generates and propagates VTP advertisements to clients; default mode on unconfigured switches

### Client Mode

Receives and forwards advertisements from servers; VLANs cannot be manually configured on switches in client mode

### Transparent Mode

Forwards advertisements but does not participate in VTP; VLANs must be configured manually

### Pruning

VLANs not having any access ports on an end switch are removed from the trunk to reduce flooded traffic

## VTP Configuration

```
Switch(config)# vtp mode {server | client | transparent}
Switch(config)# vtp domain <name>
Switch(config)# vtp password <password>
Switch(config)# vtp version {1 | 2}
Switch(config)# vtp pruning
```

## Trunk Types

	802.1Q	ISL
<b>Header Size</b>	4 bytes	26 bytes
<b>Trailer Size</b>	N/A	4 bytes
<b>Standard</b>	IEEE	Cisco
<b>Maximum VLANs</b>	4094	1000

## VLAN Numbers

<b>0</b> Reserved	<b>1004</b> fdnet
<b>1</b> default	<b>1005</b> trnet
<b>1002</b> fddi-default	<b>1006-4094</b> Extended
<b>1003</b> tr	<b>4095</b> Reserved

## Terminology

### Trunking

Carrying multiple VLANs over the same physical connection

### Native VLAN

By default, frames in this VLAN are untagged when sent across a trunk

### Access VLAN

The VLAN to which an access port is assigned

### Voice VLAN

If configured, enables minimal trunking to support voice traffic in addition to data traffic on an access port

### Dynamic Trunking Protocol (DTP)

Can be used to automatically establish trunks between capable ports (insecure)

### Switched Virtual Interface (SVI)

A virtual interface which provides a routed gateway into and out of a VLAN

## Switch Port Modes

### trunk

Forms an unconditional trunk

### dynamic desirable

Attempts to negotiate a trunk with the far end

### dynamic auto

Forms a trunk only if requested by the far end

### access

Will never form a trunk

## Troubleshooting

```
show vlan
```

```
show interface [status | switchport]
```

```
show interface trunk
```

```
show vtp status
```

```
show vtp password
```

## DHCP menggunakan Switch

Fungsi DHCP adalah memberikan alamat IP secara otomatis kepada host.

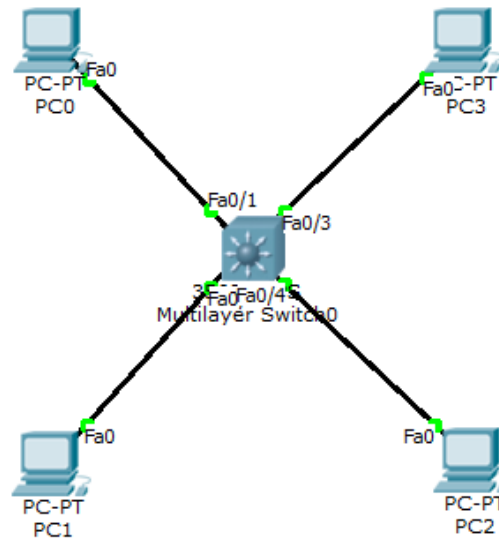

### Konfigurasi DHCP.

```
Switch(config)#ip dhcp pool vlan10
Switch(dhcp-config)#network 10.10.10.0 255.255.255.0
Switch(dhcp-config)#default-router 10.10.10.1
Switch(dhcp-config)#dns-server 8.8.8.8
Switch(dhcp-config)#ip dhcp pool vlan20
Switch(dhcp-config)#network 20.20.20.0 255.255.255.0
Switch(dhcp-config)#default-router 20.20.20.1
Switch(dhcp-config)#dns-server 8.8.8.8
```

jika ada ip yg tidak ingin digunakan dalam DHCP masukkan perintah `ip dhcp excluded-address`.

```
ip dhcp excluded-address 10.10.10.2 10.10.10.10
```

Perintah `show ip dhcp binding` menampilkan client yang mendapat ip dhcp.

```
Switch#sh ip dhcp binding
IP address      Client-ID/
                Hardware address
10.10.10.12     0003.E4A2.9D08
10.10.10.11     0001.64C9.674C
20.20.20.11     0001.4266.50B0
20.20.20.12     0002.1638.8C69
Switch#
```

IP address	Client-ID/ Hardware address	Lease expiration	Type
10.10.10.12	0003.E4A2.9D08	--	Automatic
10.10.10.11	0001.64C9.674C	--	Automatic
20.20.20.11	0001.4266.50B0	--	Automatic
20.20.20.12	0002.1638.8C69	--	Automatic

DHCP juga dapat diset manual untuk client dengan MAC Address tertentu.

```
ip dhcp pool PC_MANAGER
host 20.20.20.100
default router 20.20.20.1
client-id 0102.c7f8.0004.22
client-name Komputer_IDN
```



## Port Security

Port Security ini digunakan agar port interface perangkat cisco tidak dapat digunakan kecuali untuk PC dengan MAC Address tertentu.

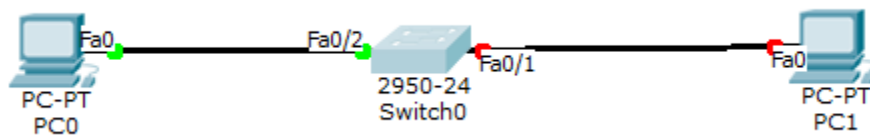

```
int fa0/1
switchport mode access
switchport port-security
switchport port-security mac-address sticky
switchport port-security violation shutdown

int fa0/2
switchport mode access
switchport port-security
switchport port-security mac-address sticky
switchport port-security violation restrict
```

Ada 3 violation:

- protect = data yg dikirim melalui port tsb dibiarkan tdk terkirim
- restrict = seperti protect namun mengirimkan notifikasi dgn snmp
- shutdown = port akan dishutdown secara otomatis, utk mengembalikannya maka harus di no shut dengan console switch atau telnet.

Sticky artinya bahwa MAC address yang pertama kali lewat switch maka itulah yang digunakan. Jika bukan MAC address tsb yang tersambung ke port yang diset port-security maka akan diproses tergantung violation yang diset.

```
show port-security
Switch#show port-security
Secure Port MaxSecureAddr CurrentAddr SecurityViolation Security Action
          (Count)          (Count)          (Count)
-----
Fa0/1          1              1              1              Shutdown
Fa0/2          1              1              1              Restrict
-----
Switch#
```

## Spanning Tree Protocol (STP)

Spanning Tree Protocol (STP) merupakan protocol yang berfungsi mencegah loop pada switch ketika switch menggunakan lebih dari 1 link dengan maksud redundancy. STP secara defaultnya diset aktif pada Cisco Catalyst. STP merupakan open standard (IEEE 802.1D). STP dapat mencegah:

- Broadcast Storm
- Multiple Frame Copies
- Database Instability

Ada beberapa jenis STP:

- Open Standard : STP (802.1D), Rapid STP (802.1W), Multiple Spanning Tree MST (802.1S)
- Cisco Proprietary : PVST (Per Vlan Spanning Tree), PVST+, Rapid PVST.



Ketika Switch0 mengirim packet data dengan destination yang tidak terdapat pada MAC address tabelnya, maka Switch0 akan membroadcast ke semua port sampai ke Switch1. Jika pada tabel MAC address Switch1 juga tidak terdapat destination tadi maka Switch1 akan kembali membroadcast ke Switch0 dan akan seperti itu sehingga network down.

Ada beberapa cara mengatasi hal tersebut:

- Hanya menggunakan 1 link (no redundancy)
- Shutdown salah satu interface, melakukan shutdown manual pada salah satu interface atau secara otomatis menggunakan STP.

STP akan membuat blocking atau shutdown pada salahsatu port untuk mencegah terjadinya loop. Ketika link utama down maka port yang sebelumnya blocking akan menjadi forward. Port blocking ditunjukkan dengan warna merah.

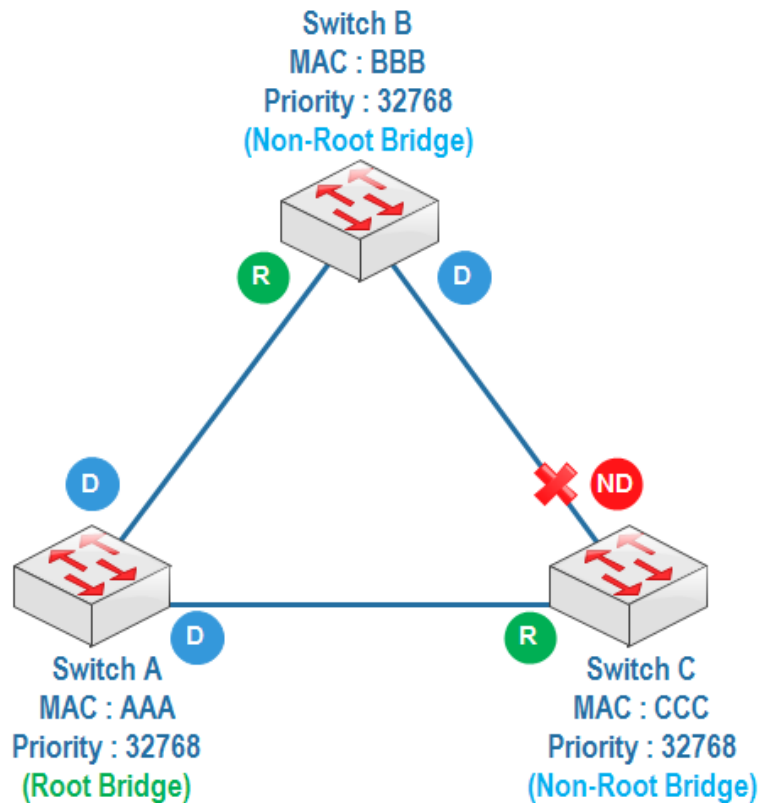

Cara kerja STP :

1. Ketika STP aktif, masing-masing switch akan mengirimkan frame khusus satu sama lain yang disebut **Bridge Protocol Data Unit (BPDU)**.

2. Menentukan Root Bridge

Switch dengan bridge id terendah akan menjadi root bridge. Bridge id = priority + MAC address. Dalam satu LAN hanya ada satu switch sebagai root bridge, switch lain menjadi non-root bridge. Default priority adalah 32768 dan bisa diubah.

3. Menentukan Root Port

Yang menjadi root port adalah path yang paling dekat dengan root bridge. Untuk setiap non-root bridge hanya punya 1 root port.

4. Menentukan designated port dan non-designated port

Designated port adalah port yang forward dan non designated port adalah port yang blocking. Untuk root bridge semua portnya adalah designated port.

Switch dengan priority terendah, salah satu portnya akan menjadi non-designated port atau port blocking. Jika priority sama maka akan dilihat MAC address terendah.

STP akan membuat blocking atau shutdown pada salahsatu port untuk mencegah terjadinya loop. Ketika link utama down maka port yang sebelumnya blocking akan menjadi forward. Port blocking ditunjukkan dengan warna merah.

STP menggunakan link cost calculation untuk menentukan root port pada non-root switch.

- 10 Gbps = Cost 2
- 1 Gbps = Cost 4
- 100 Mbps = Cost 19
- 10 Mbps = Cost 100

## Spanning Tree Protocol (STP)

Buatlah topologi seperti dibawah.

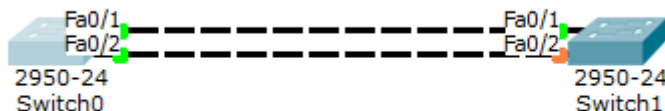

```
Switch0#show spanning-tree
VLAN0001
  Spanning tree enabled protocol ieee
  Root ID    Priority    32769
            Address    000B.BE80.D273
            Cost      19
            Port      1(FastEthernet0/1)
            Hello Time 2 sec  Max Age 20 sec  Forward Delay 15 sec

  Bridge ID  Priority    32769 (priority 32768 sys-id-ext 1)
            Address    00D0.FFDA.ECBC
            Hello Time 2 sec  Max Age 20 sec  Forward Delay 15 sec
            Aging Time 20

Interface          Role Sts Cost          Prio.Nbr Type
-----
-
Fa0/2              Altn BLK 19           128.2   P2p
Fa0/1              Root FWD 19           128.1   P2p

Switch0#
```

```
Switch1#sh spanning-tree
VLAN0001
  Spanning tree enabled protocol ieee
  Root ID    Priority    32769
```

```

Address      000B.BE80.D273
This bridge is the root
Hello Time   2 sec  Max Age 20 sec  Forward Delay 15 sec

Bridge ID    Priority    32769  (priority 32768 sys-id-ext 1)
Address      000B.BE80.D273
Hello Time   2 sec  Max Age 20 sec  Forward Delay 15 sec
Aging Time   20

Interface    Role Sts Cost      Prio.Nbr Type
-----
-
Fa0/1        Desg FWD 19        128.1    P2p
Fa0/2        Desg FWD 19        128.2    P2p

Switch1#

```

Secara otomatis, Switch0 menjadi root bridge dilihat dari semua portnya yang forward (berwarna hijau), agar Switch1 yang menjadi root bridge, ubah priority pada Switch1.

```
Switch1(config)#spanning-tree vlan 1 priority 0
```

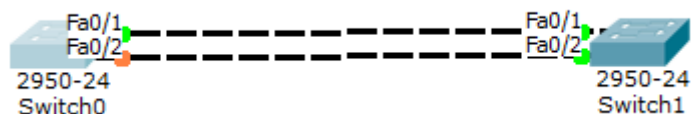

Sekarang Switch1 yang menjadi root bridge. Untuk memindahkan blocking port dari fa0/2 menjadi fa0/1 pada Switch1 jalankan perintah berikut.

```
Switch1(config)#int f0/1
Switch1(config-if)#speed 10
```

Cek Hasilnya. Port blocking pindah ke fa0/1.

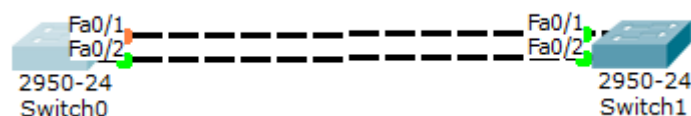

```
Switch1(config-if)#do show spanning-tree
VLAN0001
Spanning tree enabled protocol ieee
Root ID    Priority    1
Address    00D0.FFDA.ECBC
Cost       19
Port       2(FastEthernet0/2)
Hello Time 2 sec  Max Age 20 sec  Forward Delay 15 sec

Bridge ID  Priority    32769  (priority 32768 sys-id-ext 1)
Address    000B.BE80.D273
Hello Time 2 sec  Max Age 20 sec  Forward Delay 15 sec
Aging Time 20

Interface    Role Sts Cost      Prio.Nbr Type
-----
-

```

```

-
Fa0/1      Altn BLK 100      128.1      P2p
Fa0/2      Root FWD 19         128.2      P2p

```

## STP Portfast

Portfast adalah salahsatu fitur STP. Ketika pertama kali mencolokkan kabel ke switch, perlu waktu agak lama dari proses blocking yang ditandai warna oranye pada lampu indicator untuk menjadi forwarding yang ditandai dengan warna kuning.

STP Port States:

Blocking    20 second/no limits  
 Listening    15 second  
 Learning    15 second  
 Forwarding no limits  
 Disable     no limits



Hal ini disebabkan switch melakukan step listening dan learning terlebih dahulu sebelum forward. Dari proses blocking, listening dan learning kira-kira dibutuhkan waktu 30 detik. Untuk langsung ke forward tanpa melalui listening dan learning maka digunakan portfast. Portfast cocok digunakan untuk port yang mengarah ke end host. Untuk port yang mengarah ke switch, maka tidak direkomendasikan karena akan mematikan fungsi STP dalam mencegah looping.

Misalkan port 1 sampai 4 yang mau dikonfigurasi stp portfast maka ketikkan perintah berikut.

```

int range fa0/1 - 4
spanning-tree portfast

```

Maka ketika mencolokkan kabel ke switch akan langsung kuning.

## Etherchannel

Karena adanya fitur STP, akan ada port yang blocking untuk mencegah loop. Etherchannel digunakan untuk membundle beberapa link seolah-olah menjadi satu link secara logical, sehingga STP harus dimatikan dan tidak ada port blocking.

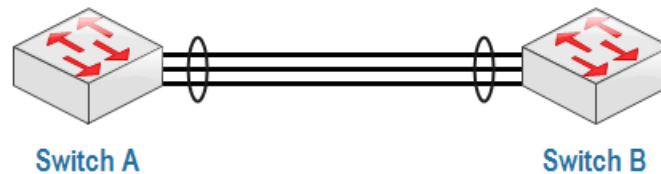

Dengan etherchannel maka transfer data lebih cepat dan tidak tergantung hanya pada 1 link. Etherchannel dapat dikonfigurasi dengan beberapa mekanisme:

- Static Persistence, tanpa menggunakan negotiation protocol.
- Dengan menggunakan negotiation protocol:
  - LACP (Link Aggregation Control Protocol) – open standard IEEE 802.1AD.
  - PAgP (Port Aggregation Protocol) – cisco proprietary.

Buat topologi seperti dibawah.

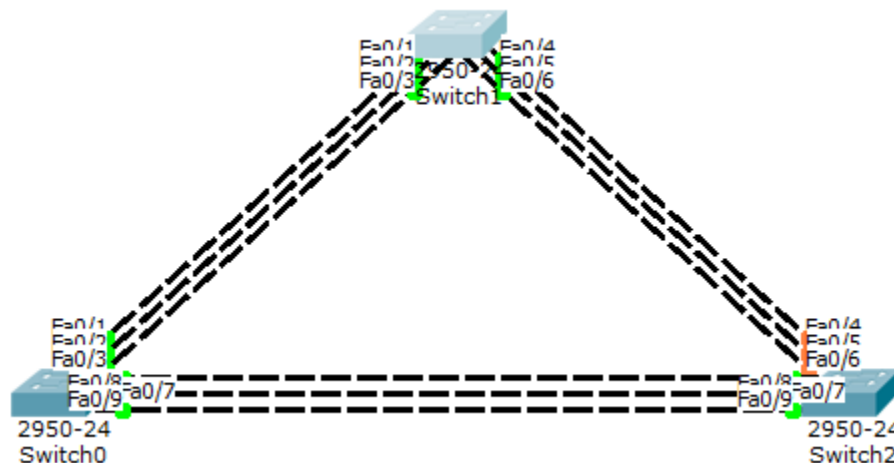

Konfigurasi LaCP pada switch kiri dan tengah.

```
Switch(config)#int range fa0/1-3
Switch(config-if-range)#channel-group 1 mode ?
  active      Enable LACP unconditionally
  auto       Enable PAgP only if a PAgP device is detected
  desirable  Enable PAgP unconditionally
  on         Enable Etherchannel only
  passive    Enable LACP only if a LACP device is detected
Switch(config-if-range)#channel-group 1 mode active
Switch(config-if-range)#int port-channel 1
```

```
Switch(config-if)#switchport mode trunk
```

Mode yang digunakan dalam LACP boleh active-active atau active-passive namun tidak boleh passive-passive.

```
Switch#sh etherchannel summary
Flags:  D - down          P - in port-channel
        I - stand-alone  s - suspended
        H - Hot-standby (LACP only)
        R - Layer3       S - Layer2
        U - in use       f - failed to allocate aggregator
        u - unsuitable for bundling
        w - waiting to be aggregated
        d - default port
```

```
Number of channel-groups in use: 1
Number of aggregators:          1
```

```
Group  Port-channel  Protocol  Ports
-----+-----+-----+-----
---
1      Po1(SU)         LACP     Fa0/1(P) Fa0/2(P) Fa0/3(P)
Switch#
```

Konfigurasi PAgP pada switch tengah dan kanan.

```
Switch(config)#int range fa0/4-6
Switch(config-if-range)#channel-group 2 mode desirable
Switch(config-if-range)#int port-channel 2
Switch(config-if)#switchport mode trunk
```

Pada PAgP dapat menggunakan mode desirable-desirable atau desirable-auto. Sekarang cek di switch yang tengah.

```
Switch#sh etherchannel summary
Flags:  D - down          P - in port-channel
        I - stand-alone  s - suspended
        H - Hot-standby (LACP only)
        R - Layer3       S - Layer2
        U - in use       f - failed to allocate aggregator
        u - unsuitable for bundling
        w - waiting to be aggregated
        d - default port
```

```
Number of channel-groups in use: 2
Number of aggregators:          2
```

```
Group  Port-channel  Protocol  Ports
-----+-----+-----+-----
---
1      Po1(SU)         LACP     Fa0/1(P) Fa0/2(P) Fa0/3(P)
2      Po2(SU)         PAgP     Fa0/4(P) Fa0/5(P) Fa0/6(P)
Switch#
```



## Konfigurasi etherchannel manual, tanpa LACP atau PAgP pada switch kiri dan kanan.

```
Switch(config)#int range fa0/7-9
Switch(config-if-range)#channel-group 3 mode on
Switch(config-if-range)#int port-channel 3
Switch(config-if)#switchport mode trunk
```

```
Switch#sh etherchannel summary
Flags:  D - down          P - in port-channel
        I - stand-alone  s - suspended
        H - Hot-standby (LACP only)
        R - Layer3       S - Layer2
        U - in use       f - failed to allocate aggregator
        u - unsuitable for bundling
        w - waiting to be aggregated
        d - default port
```

```
Number of channel-groups in use: 2
Number of aggregators:          2
```

Group	Port-channel	Protocol	Ports
1	Po1 (SU)	LACP	Fa0/1 (P) Fa0/2 (P) Fa0/3 (P)
3	Po3 (SU)	-	Fa0/7 (P) Fa0/8 (P) Fa0/9 (P)

```
Switch#
```

## Spanning Tree Protocols

	Legacy STP	PVST	PVST+	RSTP	RPVST+	MST
<b>Algorithm</b>	Legacy ST	Legacy ST	Legacy ST	Rapid ST	Rapid ST	Rapid ST
<b>Defined By</b>	802.1D-1998	Cisco	Cisco	802.1w, 802.1D-2004	Cisco	802.1s, 802.1Q-2003
<b>Instances</b>	1	Per VLAN	Per VLAN	1	Per VLAN	Configurable
<b>Trunking</b>	N/A	ISL	802.1Q, ISL	N/A	802.1Q, ISL	802.1Q, ISL

## Spanning Tree Instance Comparison

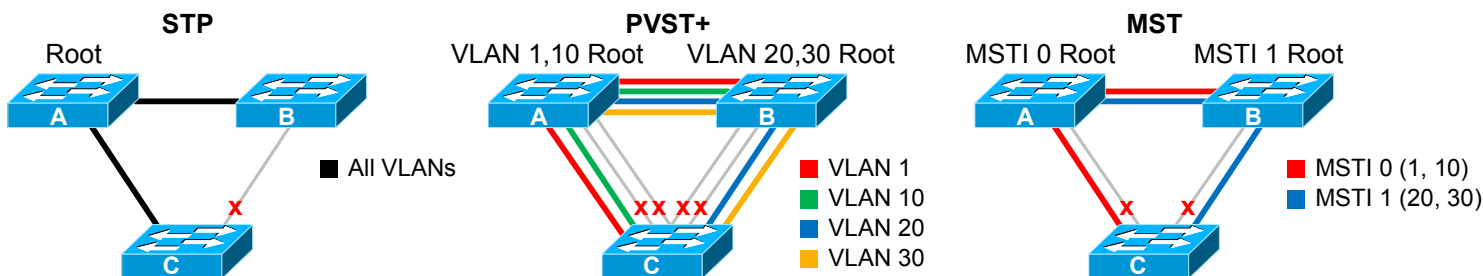

BPDU Format	
Field	Bits
Protocol ID	16
Version	8
BPDU Type	8
Flags	8
Root ID	64
Root Path Cost	32
Bridge ID	64
Port ID	16
Message Age	16
Max Age	16
Hello Time	16
Forward Delay	16

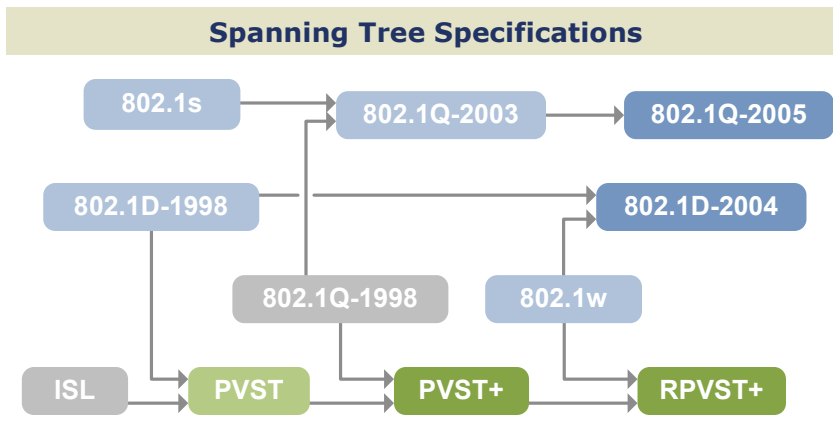

Link Costs	
Bandwidth	Cost
4 Mbps	250
10 Mbps	100
16 Mbps	62
45 Mbps	39
100 Mbps	19
155 Mbps	14
622 Mbps	6
1 Gbps	4
10 Gbps	2
20+ Gbps	1

IEEE	<b>IEEE 802.1D-1998</b> · Deprecated legacy STP standard
	<b>IEEE 802.1w</b> · Introduced RSTP
	<b>IEEE 802.1D-2004</b> · Replaced legacy STP with RSTP
	<b>IEEE 802.1s</b> · Introduced MST
Cisco	<b>IEEE 802.1Q-2003</b> · Added MST to 802.1Q
	<b>IEEE 802.1Q-2005</b> · Most recent 802.1Q revision
	<b>PVST</b> · Per-VLAN implementation of legacy STP
	<b>PVST+</b> · Added 802.1Q trunking to PVST
	<b>RPVST+</b> · Per-VLAN implementation of RSTP

Default Timers	
Hello	2s
Forward Delay	15s
Max Age	20s

Port States	
Legacy ST	Rapid ST
Disabled	Discarding
Blocking	Listening
Listening	Learning
Learning	Forwarding
Forwarding	Forwarding

## Spanning Tree Operation

- Determine root bridge**  
The bridge advertising the lowest bridge ID becomes the root bridge
- Select root port**  
Each bridge selects its primary port facing the root
- Select designated ports**  
One designated port is selected per segment
- Block ports with loops**  
All non-root and non-designated ports are blocked

Port Roles	
Legacy ST	Rapid ST
Root	Root
Designated	Designated
Blocking	Alternate Backup

## PVST+ and RPVST+ Configuration

```
spanning-tree mode {pvst | rapid-pvst}

! Bridge priority
spanning-tree vlan 1-4094 priority 32768

! Timers, in seconds
spanning-tree vlan 1-4094 hello-time 2
spanning-tree vlan 1-4094 forward-time 15
spanning-tree vlan 1-4094 max-age 20

! PVST+ Enhancements
spanning-tree backbonefast
spanning-tree uplinkfast

! Interface attributes
interface FastEthernet0/1
 spanning-tree [vlan 1-4094] port-priority 128
 spanning-tree [vlan 1-4094] cost 19

! Manual link type specification
spanning-tree link-type {point-to-point | shared}

! Enables PortFast if running PVST+, or
! designates an edge port under RPVST+
spanning-tree portfast

! Spanning tree protection
spanning-tree guard {loop | root | none}

! Per-interface toggling
spanning-tree bpduguard enable
spanning-tree bpdufilter enable
```

## MST Configuration

```
spanning-tree mode mst

! MST Configuration
spanning-tree mst configuration
 name MyTree
 revision 1

! Map VLANs to instances
instance 1 vlan 20, 30
instance 2 vlan 40, 50

! Bridge priority (per instance)
spanning-tree mst 1 priority 32768

! Timers, in seconds
spanning-tree mst hello-time 2
spanning-tree mst forward-time 15
spanning-tree mst max-age 20

! Maximum hops for BPDUs
spanning-tree mst max-hops 20

! Interface attributes
interface FastEthernet0/1
 spanning-tree mst 1 port-priority 128
 spanning-tree mst 1 cost 19
```

## Bridge ID Format

4	12	48
Pri	Sys ID Ext	MAC Address

### Priority

4-bit bridge priority (configurable from 0 to 61440 in increments of 4096)

### System ID Extension

12-bit value taken from VLAN number (IEEE 802.1t)

### MAC Address

48-bit unique identifier

## Path Selection

- 1 Bridge with lowest root ID becomes the root
- 2 Prefer the neighbor with the lowest cost to root
- 3 Prefer the neighbor with the lowest bridge ID
- 4 Prefer the lowest sender port ID

## Optional PVST+ Enhancements

### PortFast

Enables immediate transition into the forwarding state (designates edge ports under MST)

### UplinkFast

Enables switches to maintain backup paths to root

### BackboneFast

Enables immediate expiration of the Max Age timer in the event of an indirect link failure

## Spanning Tree Protection

### Root Guard

Prevents a port from becoming the root port

### BPDU Guard

Error-disables a port if a BPDU is received

### Loop Guard

Prevents a blocked port from transitioning to listening after the Max Age timer has expired

### BPDU Filter

Blocks BPDUs on an interface (disables STP)

## RSTP Link Types

### Point-to-Point

Connects to exactly one other bridge (full duplex)

### Shared

Potentially connects to multiple bridges (half duplex)

### Edge

Connects to a single host; designated by PortFast

## Troubleshooting

```
show spanning-tree [summary | detail | root]
show spanning-tree [interface | vlan]
show spanning-tree mst [...]
```

## VLAN Trunking Protocol (VTP)

VLAN Trunking Protocol (VTP) adalah protocol yang mengatur VLAN pada beberapa switch sekaligus dalam VTP domain yang sama. VTP dapat menambah, mendelete dan merename VLAN sekaligus dalam beberapa switch. VTP meringankan kerja administrator sehingga tidak perlu mengkonfigurasi VLAN pada switch satu per satu.

VTP merupakan protocol cisco proprietary. Konfigurasi VLAN disimpan dalam file database vlan.dat di flash memory.

Ada 3 VTP mode:

- Server (dafault)
- Client
- Transparent

	VTP Server	VTP Client	VTP Transparent
Create/Modify/Delete VLAN	Yes	No	Only local
Synchronizes itself	Yes	Yes	No
Forwards advertisements	Yes	Yes	Yes

Dalam VTP ada namanya revision number. Revision number adalah banyaknya update VTP yang telah diterima suatu switch.

Hal yang penting mengenai revision number adalah ketika switch mode server atau client dengan VTP domain yang sama dan mempunyai revision number yang lebih tinggi, ketika diletakkan dalam sebuah jaringan, maka otomatis mengirim update VLAN databasenya dan mereplace database switch sebelumnya sehingga membuat network down. Switch mode server akan tetap tereplace datatbasenya karena mode server pada dasarnya merupakan mode client juga.

Solusinya dengan direset terlebih dahulu.

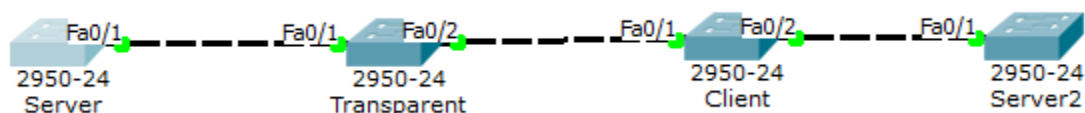

Konfigurasikan command dibawah pada semua switch.

```
Switch(config)#interface range fa0/1-2
Switch(config-if-range)#switchport mode trunk
```

Server

```
Switch(config)#int vlan 1
Switch(config-if)#ip add 10.10.10.1 255.255.255.0
Switch(config-if)#no shut
Switch(config-if)#vtp mode server
Switch(config)#vtp domain belajar
Switch(config)#vtp password rahasia
```

## Transparent

```
Switch(config)#int vlan 1
Switch(config-if)#ip add 10.10.10.2 255.255.255.0
Switch(config-if)#no shut
Switch(config-if)#vtp mode transparent
Switch(config)#vtp domain belajar
Switch(config)#vtp password rahasia
```

## Client

```
Switch(config)#int vlan 1
Switch(config-if)#ip add 10.10.10.3 255.255.255.0
Switch(config-if)#no shut
Switch(config-if)#vtp mode client
Switch(config)#vtp domain belajar
Switch(config)#vtp password rahasia
```

## Server2

```
Switch(config)#int vlan 1
Switch(config-if)#ip add 10.10.10.4 255.255.255.0
Switch(config-if)#no shut
Switch(config-if)#vtp mode server
Switch(config)#vtp domain belajar
Switch(config)#vtp password rahasia
```

Buat VLAN pada masing-masing switch.

- Server : VLAN10, VLAN20
- Transparent : VLAN30, VLAN40
- Client : VLAN50, VLAN60
- Server2 : VLAN70, VLAN80

Hasilnya Server ada 4 VLAN.

```
Switch#show vlan
```

VLAN	Name	Status	Ports
10	VLAN0010	active	
20	VLAN0020	active	
70	VLAN0070	active	
80	VLAN0080	active	

Transparent ada 2 VLAN.

```
Switch#sh vlan
```

VLAN	Name	Status	Ports
------	------	--------	-------

```
30 VLAN0030 active
40 VLAN0040 active
```

### Client ada 4 VLAN

```
Switch#SH VLAN
```

VLAN	Name	Status	Ports
10	VLAN0010	active	
20	VLAN0020	active	
70	VLAN0070	active	
80	VLAN0080	active	

### Server2 ada 4 VLAN.

```
Switch#SH VLAN
```

VLAN	Name	Status	Ports
10	VLAN0010	active	
20	VLAN0020	active	
70	VLAN0070	active	
80	VLAN0080	active	

# ROUTING

Static Routing

Default Routing

Enhanced Interior Gateway Protocol (EIGRP)

Open Shortest Path First (OSPF)

Standard Access List

Extended Access List

Static NAT

Overloading/Port Address Translation (PAT)

HSRP

# Routing Overview

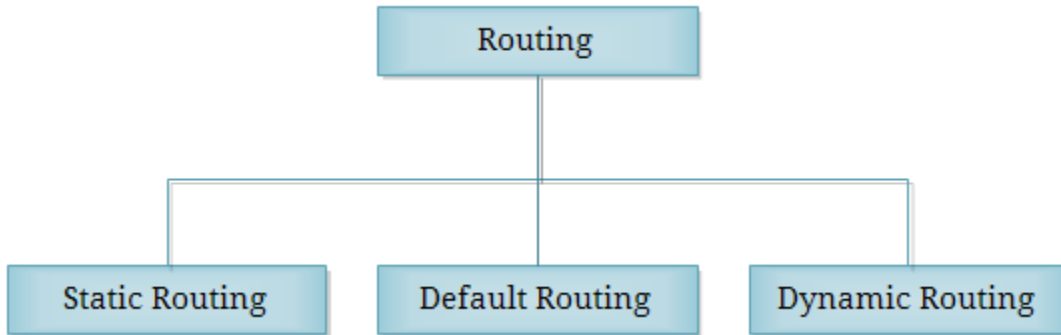

Routing adalah mengirimkan packet data dari satu network ke network lain. Perangkat yang digunakan dalam routing adalah router. Router digunakan untuk best path selection dan packets forwarding.

Untuk menuju ke destination, router dapat dikonfigurasi dengan 2 cara:

- Manually, memasukkan route ke tabel routing secara manual (static routing).
- Dynamically, menggunakan protocol routing (dynamic routing).

## Dynamic Routing vs Static Routing

	Dynamic Routing	Static Routing
<b>Configuration Complexity</b>	Generally independent of the network size	Increases with the network size
<b>Topology Changes</b>	Automatically adapts to topology changes	Administrator intervention required
<b>Scaling</b>	Suitable for simple and complex topologies	Suitable for simple topologies
<b>Security</b>	Less secure	More secure
<b>Resource Usage</b>	Uses CPU, memory, link bandwidth	No extra resources needed
<b>Predictability</b>	Route depends on the current topology	Route to destination is always the same



## Static Routing

Dalam static routing, network administrator memasukkan route ke tabel routing secara manual untuk menuju ke spesifik network. Konfigurasi harus diupdate secara manual setiap terjadi perubahan topologi.

- Static Routing mempunyai Administrative Distance (AD) 1 sehingga akan lebih dipilih daripada dynamic routing.
- Better security, static routes tidak diadvertise dalam network.
- Use less bandwidth daripada dynamic routing protocol, karena tidak melakukan pertukaran route.
- No CPU cycles are used to calculate and communicate routes.
- The path a static route uses to send data is known.
- Konfigurasi dan maintenance yang memakan waktu
- Tidak cocok untuk network skala besar.
- Untuk jaringan kecil yang tidak akan terjadi perubahan topologi secara significant
- Routing ke/dari stub network. Stub network adalah jaringan yang diakses hanya mempunyai 1 exit path (karena hanya mempunyai satu neighbor).
- Untuk unknown network menggunakan default route.

**ip route** (spasi) **destination network** (spasi) **subnetmask** (spasi) **ip/interface next-hop**

Buatlah topologi dibawah dan konfigurasi interfacenya.

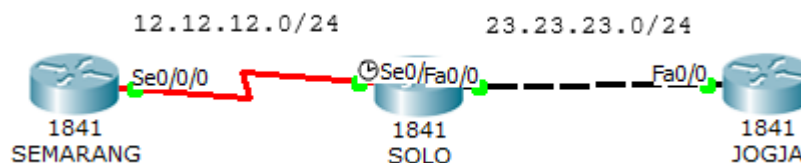

```
Router(config)#hostname SEMARANG
SEMARANG(config)#interface s0/0/0
SEMARANG(config-if)#ip address 12.12.12.1 255.255.255.0
SEMARANG(config-if)#no shutdown
```

```
Router(config)#hostname SOLO
SOLO(config)#interface s0/0/0
SOLO(config-if)#ip address 12.12.12.2 255.255.255.0
SOLO(config-if)#no shutdown
SOLO(config-if)#interface f0/0
```

```
SOLO(config-if)#ip address 23.23.23.2 255.255.255.0
SOLO(config-if)#no shutdown
```

```
Router(config)#hostname JOGJA
JOGJA(config)#interface f0/0
JOGJA(config-if)#ip address 23.23.23.3 255.255.255.0
JOGJA(config-if)#no shutdown
```

**Konfigurasi routing static pada router Semarang dan Jogja. Router Solo tidak perlu dikonfigurasi static routing karena sudah direct connected dengan router Semarang dan Jogja.**

```
SEMARANG(config-if)#ip route 23.23.23.0 255.255.255.0 12.12.12.2
JOGJA(config-if)#ip route 12.12.12.0 255.255.255.0 23.23.23.2
```

**Sekarang cek ping dan lihat tabel routing.**

```
JOGJA#ping 12.12.12.1
```

```
Type escape sequence to abort.
Sending 5, 100-byte ICMP Echos to 12.12.12.1, timeout is 2 seconds:
.!!!!
Success rate is 80 percent (4/5), round-trip min/avg/max = 3/6/17 ms
```

```
JOGJA#show ip route
```

```
Codes: C - connected, S - static, I - IGRP, R - RIP, M - mobile, B - BGP
        D - EIGRP, EX - EIGRP external, O - OSPF, IA - OSPF inter area
        N1 - OSPF NSSA external type 1, N2 - OSPF NSSA external type 2
        E1 - OSPF external type 1, E2 - OSPF external type 2, E - EGP
        i - IS-IS, L1 - IS-IS level-1, L2 - IS-IS level-2, ia - IS-IS inter
area
        * - candidate default, U - per-user static route, o - ODR
        P - periodic downloaded static route
```

```
Gateway of last resort is not set
```

```
      12.0.0.0/24 is subnetted, 1 subnets
S       12.12.12.0 [1/0] via 23.23.23.2
      23.0.0.0/24 is subnetted, 1 subnets
C       23.23.23.0 is directly connected, FastEthernet0/0
JOGJA#
```

```
SEMARANG#ping 23.23.23.3
```

```
Type escape sequence to abort.
Sending 5, 100-byte ICMP Echos to 23.23.23.3, timeout is 2 seconds:
!!!!!!
Success rate is 100 percent (5/5), round-trip min/avg/max = 1/4/14 ms
```

```
SEMARANG#sh ip route
```

```
Codes: C - connected, S - static, I - IGRP, R - RIP, M - mobile, B - BGP
        D - EIGRP, EX - EIGRP external, O - OSPF, IA - OSPF inter area
        N1 - OSPF NSSA external type 1, N2 - OSPF NSSA external type 2
        E1 - OSPF external type 1, E2 - OSPF external type 2, E - EGP
```

```

i - IS-IS, L1 - IS-IS level-1, L2 - IS-IS level-2, ia - IS-IS inter
area
* - candidate default, U - per-user static route, o - ODR
P - periodic downloaded static route

Gateway of last resort is not set

12.0.0.0/24 is subnetted, 1 subnets
C    12.12.12.0 is directly connected, Serial0/0/0
23.0.0.0/24 is subnetted, 1 subnets
S    23.23.23.0 [1/0] via 12.12.12.2
SEMARANG#

```

Static routing ditandai dengan tanda S. Ketika ditraceroute, maka melewati 12.12.12.1 sebagai next-hop menuju network 23.23.23.0/24.

```

SEMARANG#traceroute 23.23.23.3
Type escape sequence to abort.
Tracing the route to 23.23.23.3

 1  12.12.12.2      0 msec    0 msec    0 msec
 2  23.23.23.3      1 msec    1 msec    4 msec
SEMARANG#

```

## Default Routing

Default routing sebenarnya masuk dalam static routing. Biasa digunakan untuk routing ke internet. Pada tabel routing, default routing selalu berada paling bawah dan selalu menjadi last preferred (pilihan terakhir).

`ip route` (spaci) `0.0.0.0` (spaci) `0.0.0.0` (spaci) `ip/interface next-hop`

Lanjutan lab sebelumnya. Hapus dulu static route yang sebelumnya dibuat.

```

SEMARANG(config)#no ip route 23.23.23.0 255.255.255.0 12.12.12.2
JOGJA(config)#no ip route 12.12.12.0 255.255.255.0 23.23.23.2

```

Sekarang masukkan default routingnya.

```

SEMARANG(config)#ip route 0.0.0.0 0.0.0.0 12.12.12.2
JOGJA(config)#ip route 0.0.0.0 0.0.0.0 23.23.23.2

```

Sekarang tes ping dan cek tabel routing.

```

SEMARANG#ping 23.23.23.3

Type escape sequence to abort.
Sending 5, 100-byte ICMP Echos to 23.23.23.3, timeout is 2 seconds:
!!!!
Success rate is 100 percent (5/5), round-trip min/avg/max = 1/1/1 ms

```

```

SEMARANG#sh ip route
Codes: C - connected, S - static, I - IGRP, R - RIP, M - mobile, B - BGP
       D - EIGRP, EX - EIGRP external, O - OSPF, IA - OSPF inter area
       N1 - OSPF NSSA external type 1, N2 - OSPF NSSA external type 2
       E1 - OSPF external type 1, E2 - OSPF external type 2, E - EGP
       i - IS-IS, L1 - IS-IS level-1, L2 - IS-IS level-2, ia - IS-IS inter
area
       * - candidate default, U - per-user static route, o - ODR
       P - periodic downloaded static route

Gateway of last resort is 12.12.12.2 to network 0.0.0.0

    12.0.0.0/24 is subnetted, 1 subnets
C       12.12.12.0 is directly connected, Serial0/0/0
S*     0.0.0.0/0 [1/0] via 12.12.12.2
SEMARANG#

```

Default routing ditandai dengan tanda S\* dan destination 0.0.0.0/0 yang artinya ke semua ip.

## Dynamic Routing Overview

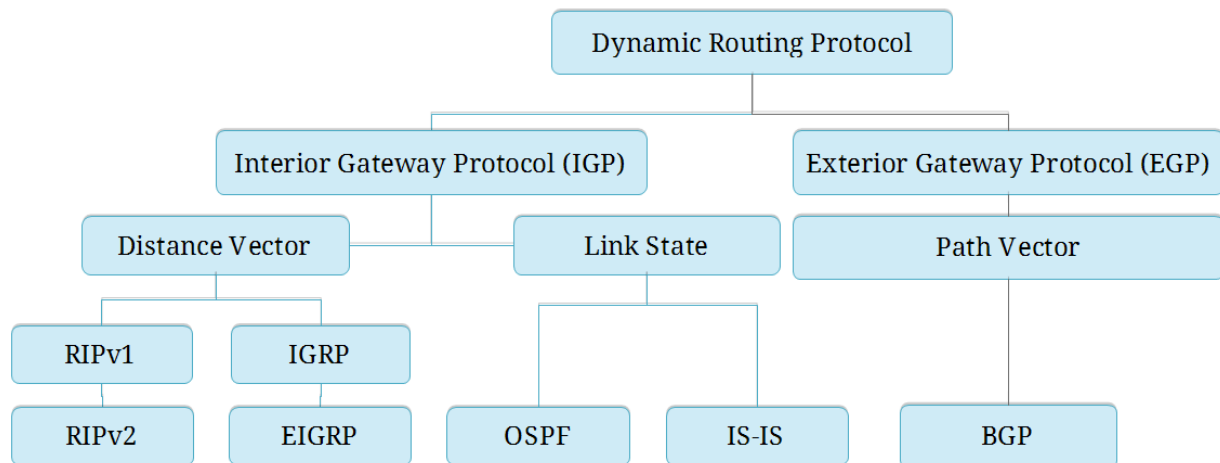

Dynamic routing menggunakan protocol routing dalam pembentukan tabel routing. Ketika topologi berubah, tabel routing akan ikut berubah secara otomatis.

- Use more bandwidth daripada static routing, karena route exchanging.
- CPU cycles are used to calculate and communicate routes.
- Cocok untuk network skala besar.

# PERBANDINGAN PROTOCOL ROUTING

	RIP v1	RIP v2	IGRP	EIGRP	OSPF	IS-IS	BGP
<i>Interior/Exterior?</i>	Interior	Interior	Interior	Interior	Interior	Interior	Exterior
<i>Type</i>	Distance Vector	Distance Vector	Distance Vector	Hybrid	Link-state	Link-state	Path Vector
<i>Default Metric</i>	Hopcount	Hopcount	Bandwidth/Delay	Bandwidth/Delay	Cost	Cost	Multiple Attributes
<i>Administrative Distance</i>	120	120	100	90 (internal) 170 (external)	110	115	20 (external) 200 (internal)
<i>Hopcount Limit</i>	15	15	255 (100 default)	224 (100 default)	None	None	EBGP Neighbors: 1 (default) IBGP Neighbors: None
<i>Convergence</i>	Slow	Slow	Slow	Very Fast	Fast	Fast	Average
<i>Update timers</i>	30 seconds	30 seconds	90 seconds	Only when change occurs	Only when changes occur; (LSA table is refreshed every 30 minutes, however)	Only when changes occur	Only when changes occur
<i>Updates</i>	Full table	Full table	Full table	Only Changes	Only Changes	Only changes	Only changes
<i>Classless</i>	No	Yes	No	Yes	Yes	Yes	Yes
<i>Supports VLSM</i>	No	Yes	No	Yes	Yes	Yes	Yes
<i>Algorithm</i>	Bellman-Ford	Bellman-Ford	Bellman-Ford	DUAL	Dijkstra	Dijkstra	Best Path Algorithm
<i>Update Address</i>	Broadcast	224.0.0.9	224.0.0.10	224.0.0.10	224.0.0.5 (All SPF Routers) 224.0.0.6 (DR's and BDR's)		Unicast
<i>Protocol and Port</i>	UDP port 520		IP Protocol 9	IP Protocol 88	IP Protocol 89		TCP port 179

## IGP dan EGP

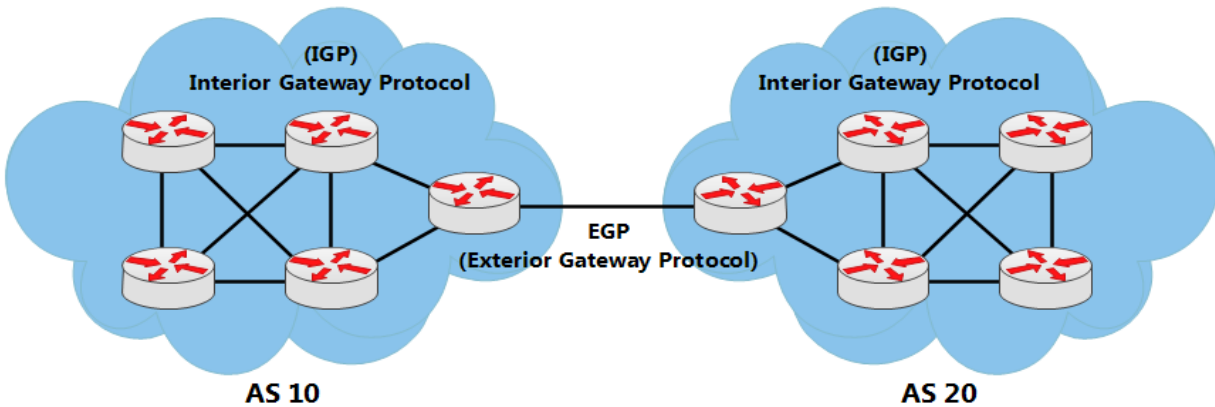

Internet tersusun atas banyak AS. Bayangkan internet itu seperti puzzle, maka AS-AS adalah potongan puzzlenya. Dan di internet ada ribuan AS. AS atau Autonomous System sendiri adalah kumpulan router didalam suatu authority yang sama.

Interior Gateway Protocol (IGP) digunakan untuk routing dalam sebuah AS (Intra-AS). IGP digunakan untuk jaringan internal dalam sebuah perusahaan, organisasi atau service provider. IGP juga dibagi menjadi 2 jenis:

- Distance Vector

Sesuai namanya, ada 2 karakteristik utama dalam penentuan routenya.

Distance = jauhnya source network menuju destination berdasarkan metric. Metric dihitung dari hop count, cost, bandwidth, delay, dll.

Vector = direction atau arah dari next hop router untuk menuju ke destination.

Protocol jenis Distance Vector hanya mengetahui route dan metric untuk menuju destination tertentu. Protocol tersebut tidak mempunyai informasi tentang map jaringan atau topologi secara keseluruhan.

Yang termasuk protocol routing distance vector: RIPv1, RIPv2, IGRP dan EIGRP.

- Link-State

Protocol jenis link-state mengetahui topologi jaringan secara keseluruhan dengan mengumpulkan informasi dari setiap router. Untuk jaringan dengan skala yang luas (large network), link-state didesign secara hierarchical atau dibagi menjadi area-area. Area yang harus ada pada link-state adalah area 0 atau backbone. Pembagian menjadi area-area ini bertujuan mengurangi resource router dengan setiap area mempunyai table routing yang berbeda dengan area yang lain.

Yang termasuk protocol routing link-state: OSPF dan IS-IS.

Exterior Gateway Protocol (EGP) digunakan untuk routing antar AS (Inter AS). Satu-satunya protocol EGP adalah BGP. BGP merupakan protocol berjenis path-

vector. Route yang dihasilkan dari BGP memuat attribute as-path. AS Path adalah urutan AS Number yang dilewati suatu route untuk sampai ke destination.

## Enhanced Interior Gateway Protocol (EIGRP)

- Cisco proprietary
- Advanced distance vector/hybrid routing protocol
- Using DUAL Algorithm.
- Multicast or unicast for exchange information use port 88
- Administrative distance 90
- Classless routing protocol support VLSM/CIDR.
- Support IPv6
- Rich metric (bandwidth, delay, load and reliability)
- Very fast convergence
- Equal and Unequal Load balancing
- 100% loop-free

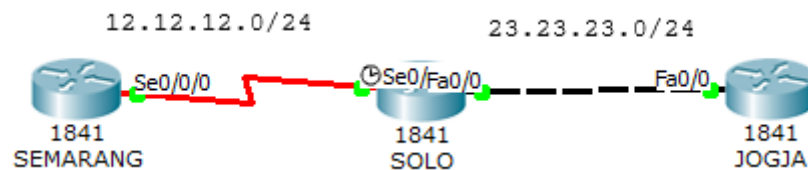

Konfigurasi interface seperti pada lab static routing dan tambahkan interface loopback pada ketiga router. Interface loopback dapat dipakai sebagai identitas dan sebagai ip logical.

```
SEMARANG(config)#int lo0
SEMARANG(config-if)#ip address 1.1.1.1 255.255.255.255

SOLO(config)#int lo0
SOLO(config-if)#ip add 2.2.2.2 255.255.255.255

JOGJA(config)#int lo0
JOGJA(config-if)#ip add 3.3.3.3 255.255.255.255
```

Konfigurasi EIGRP pada router. AS Number dalam semua router EIGRP harus sama.

```
SEMARANG(config)#router eigrp ?
<1-65535> Autonomous system number
```

```
SEMARANG(config)#router eigrp 10
SEMARANG(config-router)#network 12.12.12.0 ?
  A.B.C.D  EIGRP wild card bits
  <cr>
SEMARANG(config-router)#network 12.12.12.0 0.0.0.255
SEMARANG(config-router)#network 1.1.1.1 0.0.0.0
SEMARANG(config-router)#no auto-summary
SEMARANG(config-router)#ex
```

```
SOLO(config)#router eigrp 10
SOLO(config-router)#network 12.12.12.0 0.0.0.255
SOLO(config-router)#network 23.23.23.0 0.0.0.255
SOLO(config-router)#network 2.2.2.2 0.0.0.0
SOLO(config-router)#no auto-summary
```

```
JOGJA(config)#router eigrp 10
JOGJA(config-router)#network 23.23.23.0 0.0.0.255
JOGJA(config-router)#network 3.3.3.3 0.0.0.0
JOGJA(config-router)#no auto-summary
```

**No-auto summary bertujuan untuk menyertakan subnetmask dalam routing EIGRP. Sekarang lakukan tes ping dan traceroute ke router jogja.**

```
SEMARANG#ping 2.2.2.2

Type escape sequence to abort.
Sending 5, 100-byte ICMP Echos to 2.2.2.2, timeout is 2 seconds:
!!!!
Success rate is 100 percent (5/5), round-trip min/avg/max = 1/3/12 ms

SEMARANG#ping 3.3.3.3

Type escape sequence to abort.
Sending 5, 100-byte ICMP Echos to 3.3.3.3, timeout is 2 seconds:
!!!!
Success rate is 100 percent (5/5), round-trip min/avg/max = 1/3/11 ms

SEMARANG#traceroute 3.3.3.3
Type escape sequence to abort.
Tracing the route to 3.3.3.3

  1  12.12.12.2      0 msec    2 msec    2 msec
  2  23.23.23.3      1 msec    0 msec    1 msec
SEMARANG#
```

**Pengecekan tabel routing.**

```
SEMARANG#sh ip route

Gateway of last resort is not set

  1.0.0.0/8 is variably subnetted, 2 subnets, 2 masks
D    1.0.0.0/8 [90/2809856] via 12.12.12.2, 00:07:37, Serial0/0/0
C    1.1.1.1/32 is directly connected, Loopback0
    2.0.0.0/32 is subnetted, 1 subnets
```



```

D      2.2.2.2 [90/2297856] via 12.12.12.2, 00:07:37, Serial0/0/0
      3.0.0.0/32 is subnetted, 1 subnets
D      3.3.3.3 [90/2300416] via 12.12.12.2, 00:02:48, Serial0/0/0
      12.0.0.0/24 is subnetted, 1 subnets
C      12.12.12.0 is directly connected, Serial0/0/0
      23.0.0.0/24 is subnetted, 1 subnets
D      23.23.23.0 [90/2172416] via 12.12.12.2, 00:02:49, Serial0/0/0
SEMARANG#

```

```
SOLO#sh ip route
```

```
Gateway of last resort is not set
```

```

      1.0.0.0/8 is variably subnetted, 2 subnets, 2 masks
D      1.0.0.0/8 is a summary, 00:08:13, Null0
D      1.1.1.1/32 [90/2297856] via 12.12.12.1, 00:08:07, Serial0/0/0
      2.0.0.0/32 is subnetted, 1 subnets
C      2.2.2.2 is directly connected, Loopback0
      3.0.0.0/32 is subnetted, 1 subnets
D      3.3.3.3 [90/156160] via 23.23.23.3, 00:03:19, FastEthernet0/0
      12.0.0.0/24 is subnetted, 1 subnets
C      12.12.12.0 is directly connected, Serial0/0/0
      23.0.0.0/24 is subnetted, 1 subnets
C      23.23.23.0 is directly connected, FastEthernet0/0
SOLO#

```

```
JOGJA#sh ip route
```

```
Gateway of last resort is not set
```

```

      1.0.0.0/8 is variably subnetted, 2 subnets, 2 masks
D      1.0.0.0/8 [90/2300416] via 23.23.23.2, 00:03:39, FastEthernet0/0
D      1.1.1.1/32 [90/2300416] via 23.23.23.2, 00:03:39, FastEthernet0/0
      2.0.0.0/32 is subnetted, 1 subnets
D      2.2.2.2 [90/156160] via 23.23.23.2, 00:03:39, FastEthernet0/0
      3.0.0.0/32 is subnetted, 1 subnets
C      3.3.3.3 is directly connected, Loopback0
      12.0.0.0/24 is subnetted, 1 subnets
D      12.12.12.0 [90/2172416] via 23.23.23.2, 00:03:39, FastEthernet0/0
      23.0.0.0/24 is subnetted, 1 subnets
C      23.23.23.0 is directly connected, FastEthernet0/0
JOGJA#

```

Tanda D menunjukkan bahwa route dihasilkan melalui protocol EIGRP. AD pada EIGRP adalah 90 ditandai dengan warna kuning dan metic ditandai dengan warna biru. Perhitungan metric menggunakan rumus tersendiri.

## Open Shortest Path First (OSPF)

- Open Standard.
- Link-State routing protocol.
- Using SPF/Dijkstra Algorithm.
- Multicast for exchange information use port 89.
- Administrative distance 110.
- Classless routing protocol support VLSM/CIDR.
- Support IPv6.
- Metric using cost.
- Fast convergence.
- Equal load balancing only.
- Using areas (backbone area and non-backbone areas).

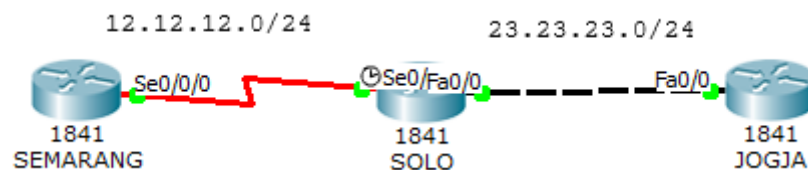

Hapus konfigurasi EIGRP sebelumnya.

```
SEMARANG(config)# no router eigrp 10
SOLO(config)# no router eigrp 10
JOGJA(config-if)# no router eigrp 10
```

Konfigurasi OSPF pada router. OSPF menggunakan process ID. Process ID pada setiap router tidak harus sama, yang terpenting adalah areanya. Untuk terhubung antara area yang satu dengan yang lain harus melewati area 0 atau area backbone.

```
SEMARANG(config)#router ospf ?
<1-65535> Process ID
SEMARANG(config)#router ospf 1
SEMARANG(config-router)#net
SEMARANG(config-router)#network 12.12.12.0 ?
A.B.C.D OSPF wild card bits
SEMARANG(config-router)#network 12.12.12.0 0.0.0.255 area 0
SEMARANG(config-router)#network 1.1.1.1 0.0.0.0 area 0
```

```
SOLO(config)#router ospf 2
SOLO(config-router)#network 12.12.12.0 0.0.0.255 area 0
SOLO(config-router)#network 23.23.23.0 0.0.0.255 area 1
SOLO(config-router)#network 2.2.2.2 0.0.0.0 area 0
```

```
JOGJA(config)#router ospf 3
JOGJA(config-router)#network 23.23.23.0 0.0.0.255 area 1
JOGJA(config-router)#network 3.3.3.3 0.0.0.0 area 1
```

## Sekarang lakukan tes ping.

```
SEMARANG#ping 2.2.2.2
```

```
Type escape sequence to abort.
Sending 5, 100-byte ICMP Echos to 2.2.2.2, timeout is 2 seconds:
!!!!
Success rate is 100 percent (5/5), round-trip min/avg/max = 1/1/2 ms
```

```
SEMARANG#ping 3.3.3.3
```

```
Type escape sequence to abort.
Sending 5, 100-byte ICMP Echos to 3.3.3.3, timeout is 2 seconds:
!!!!
Success rate is 100 percent (5/5), round-trip min/avg/max = 1/2/7 ms
```

```
SEMARANG#
```

## Cek tabel routing.

```
SEMARANG#sh ip route
```

```
Gateway of last resort is not set

    1.0.0.0/32 is subnetted, 1 subnets
C       1.1.1.1 is directly connected, Loopback0
    2.0.0.0/32 is subnetted, 1 subnets
O       2.2.2.2 [110/65] via 12.12.12.2, 00:02:45, Serial0/0/0
    3.0.0.0/32 is subnetted, 1 subnets
O IA   3.3.3.3 [110/66] via 12.12.12.2, 00:01:21, Serial0/0/0
    12.0.0.0/24 is subnetted, 1 subnets
C       12.12.12.0 is directly connected, Serial0/0/0
    23.0.0.0/24 is subnetted, 1 subnets
O IA   23.23.23.0 [110/65] via 12.12.12.2, 00:03:13, Serial0/0/0
```

```
SOLO#sh ip ro
```

```
Gateway of last resort is not set

    1.0.0.0/32 is subnetted, 1 subnets
O       1.1.1.1 [110/65] via 12.12.12.1, 00:05:40, Serial0/0/0
    2.0.0.0/32 is subnetted, 1 subnets
C       2.2.2.2 is directly connected, Loopback0
    3.0.0.0/32 is subnetted, 1 subnets
O       3.3.3.3 [110/2] via 23.23.23.3, 00:02:35, FastEthernet0/0
    12.0.0.0/24 is subnetted, 1 subnets
C       12.12.12.0 is directly connected, Serial0/0/0
    23.0.0.0/24 is subnetted, 1 subnets
C       23.23.23.0 is directly connected, FastEthernet0/0
SOLO#
```

```
JOGJA#sh ip route
```

```
Gateway of last resort is not set
```

```
    1.0.0.0/32 is subnetted, 1 subnets  
O IA    1.1.1.1 [110/66] via 23.23.23.2, 00:02:03, FastEthernet0/0  
    2.0.0.0/32 is subnetted, 1 subnets  
O IA    2.2.2.2 [110/2] via 23.23.23.2, 00:02:03, FastEthernet0/0  
    3.0.0.0/32 is subnetted, 1 subnets  
C       3.3.3.3 is directly connected, Loopback0  
    12.0.0.0/24 is subnetted, 1 subnets  
O IA    12.12.12.0 [110/65] via 23.23.23.2, 00:02:03, FastEthernet0/0  
    23.0.0.0/24 is subnetted, 1 subnets  
C       23.23.23.0 is directly connected, FastEthernet0/0  
JOGJA#
```

**Tanda O** menunjukkan bahwa route dihasilkan melalui protocol OSPF. **Tanda IA** menunjukkan bahwa destination route berada pada area yang berbeda. **AD** pada OSPF adalah 110.

## Access List (ACL)

Access List (ACL) biasa digunakan untuk filtering. Ada 2 macam access list yaitu standard dan extended.

Standard ACL	Extended ACL
ACL Number range 1-99	ACL Number range 100-199
Can block a network, host and subnet	Can allow or deny a network, host, subnet and service
All service are blocked	Select service can be blocked
Implemented closest to the destination	Implemented closest to the destination
Filtering based on source IP address only	Filtering based on source IP address, destination IP, protocol and port number

### Standard Access List

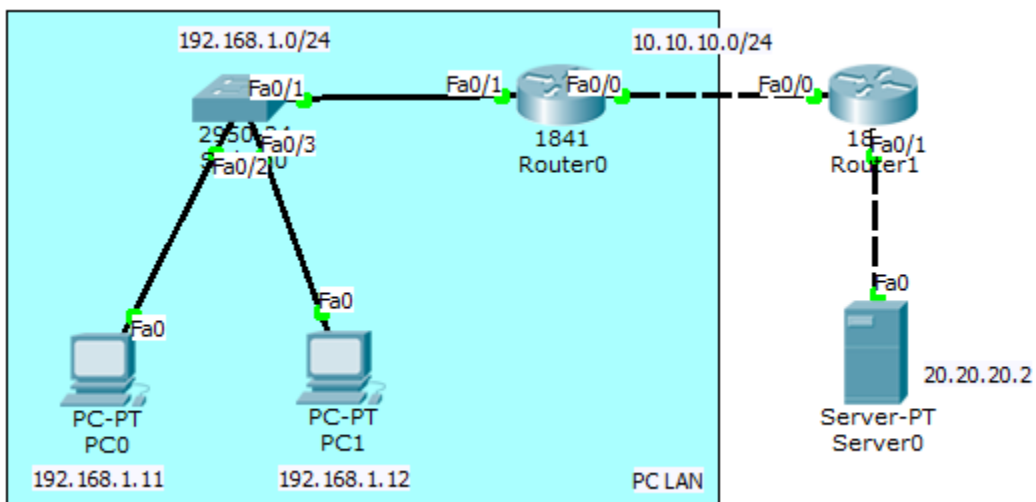

Lakukan konfigurasi supaya PC LAN dapat ping ke server.

Konfigurasi interface dan routing pada Router0.

```
Router(config)#int fa0/1
Router(config-if)#ip add 192.168.1.1 255.255.255.0
```

```
Router(config-if)#no sh
Router(config-if)#int fa0/0
Router(config-if)#ip add 10.10.10.1 255.255.255.0
Router(config-if)#no sh
Router(config-if)#ip route 20.20.20.0 255.255.255.0 10.10.10.2
```

### Konfigurasi interface dan routing pada Router1.

```
Router(config)#int fa0/0
Router(config-if)#ip add 10.10.10.2 255.255.255.0
Router(config-if)#no sh
Router(config-if)#int fa0/1
Router(config-if)#ip add 20.20.20.1 255.255.255.0
Router(config-if)#no sh
Router(config-if)#ip route 192.168.1.0 255.255.255.0 10.10.10.1
```

Berikan IP pada server dan coba cek web server melalui browser pada PC LAN.

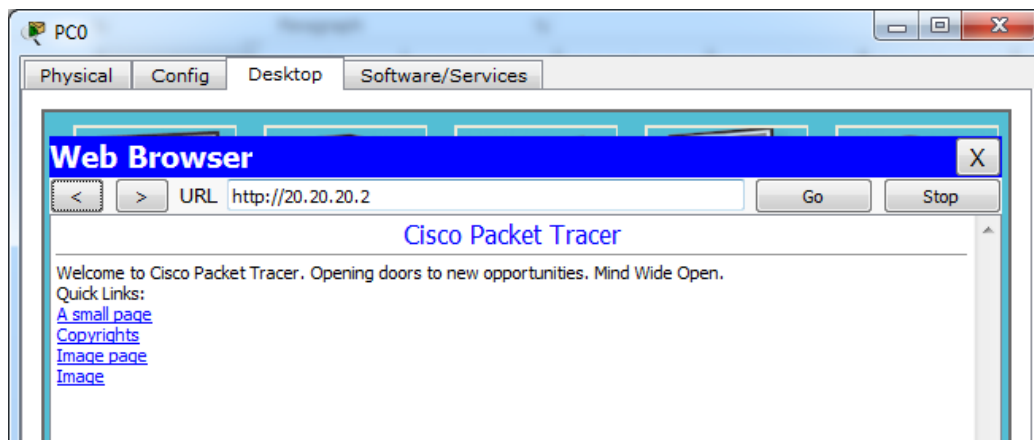
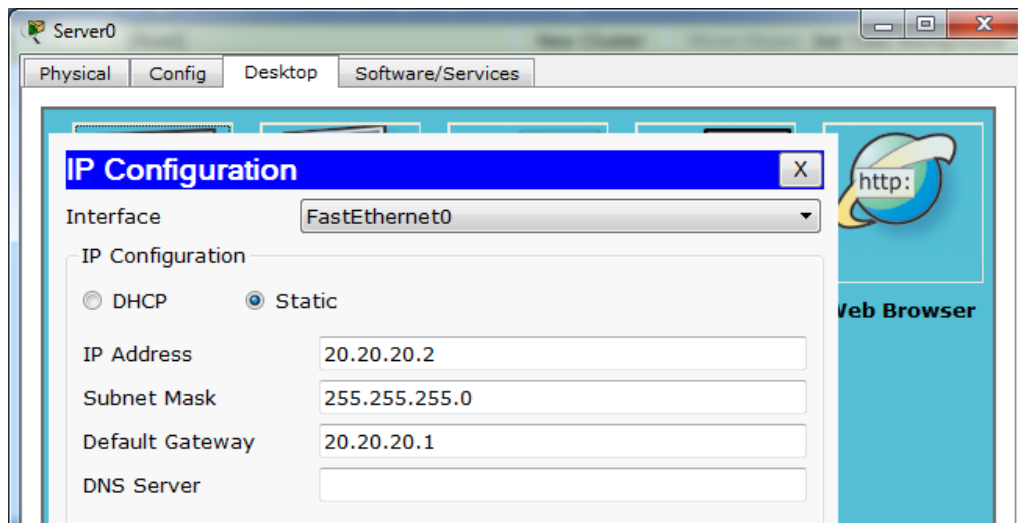

## Cek ping dari PC LAN ke web server.

```
PC>ping 20.20.20.2

Pinging 20.20.20.2 with 32 bytes of data:

Reply from 20.20.20.2: bytes=32 time=0ms TTL=126
Reply from 20.20.20.2: bytes=32 time=0ms TTL=126
Reply from 20.20.20.2: bytes=32 time=0ms TTL=126
Reply from 20.20.20.2: bytes=32 time=0ms TTL=126

Ping statistics for 20.20.20.2:
    Packets: Sent = 4, Received = 4, Lost = 0 (0% loss),
    Approximate round trip times in milli-seconds:
        Minimum = 0ms, Maximum = 0ms, Average = 0ms

PC>
```

Sekarang konfigurasi standard access list agar PC LAN tidak dapat mengakses web server. Set access list pada router dan interface yang paling dekat dengan destination.

```
Router(config)#access-list 10 deny 192.168.10.0 ?
    A.B.C.D Wildcard bits
    <cr>
Router(config)#access-list 10 deny 192.168.1.0 0.0.0.255
Router(config)#access-list 10 permit any
Router(config)#int fa0/1
Router(config-if)#ip access-group 1 out
```

## Cek ping dan akses browser dari PC LAN ke web server.

```
PC>ping 20.20.20.2

Pinging 20.20.20.2 with 32 bytes of data:

Reply from 10.10.10.2: Destination host unreachable.
Reply from 10.10.10.2: Destination host unreachable.
Reply from 10.10.10.2: Destination host unreachable.
Reply from 10.10.10.2: Destination host unreachable.

Ping statistics for 20.20.20.2:
    Packets: Sent = 4, Received = 0, Lost = 4 (100% loss),

PC>
```

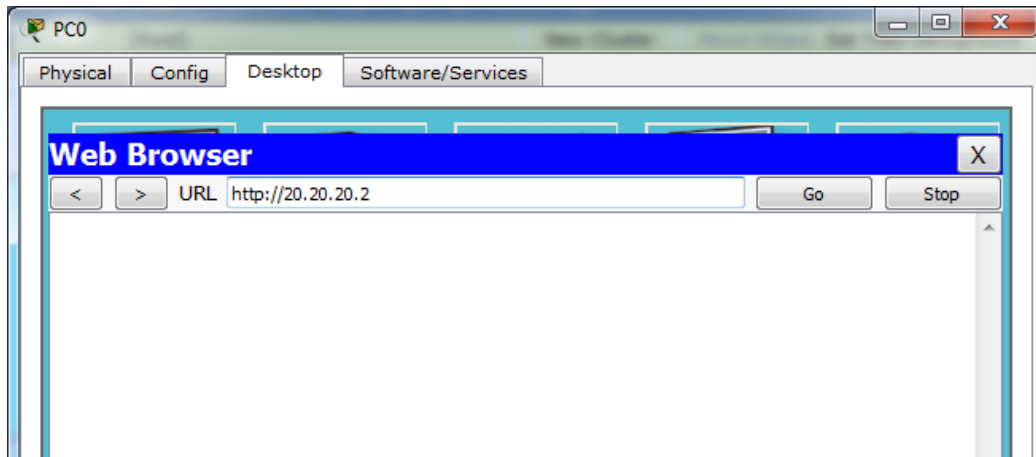

Cek access list pada Router1.

```
Router#show access-lists
Standard IP access list 10
  deny 192.168.1.0 0.0.0.255 (64 match(es))
  permit any (5 match(es))
Router#
```

Pada standard access list, semua service akan diblok, baik UDP untuk akses browser atau ICMP untuk ping. Untuk memilih hanya service tertentu saja, gunakan extended access list.

## Extended Access List

Extended access list mengizinkan hanya service tertentu saja yang diblok. Gambar dibawah adalah jenis-jenis service beserta aplikasinya.

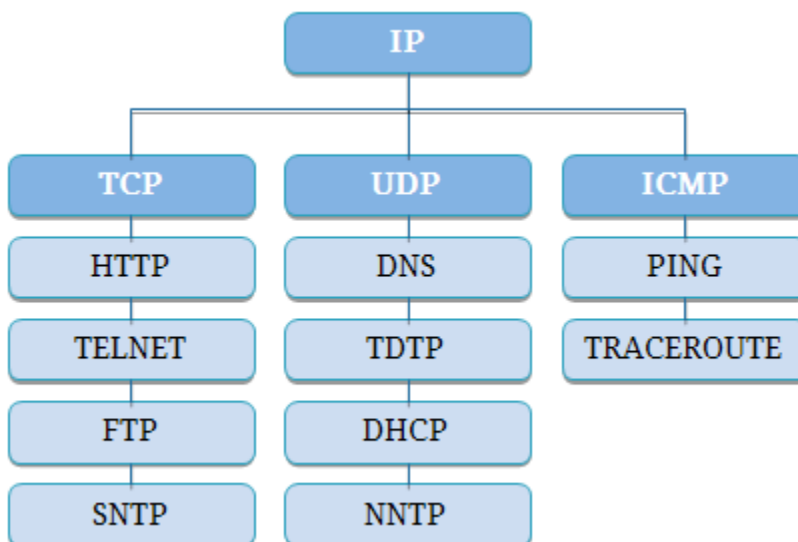



Masih memakai topologi dari lab sebelumnya. Hapus dulu standard access list yang telah dibuat pada Router1.

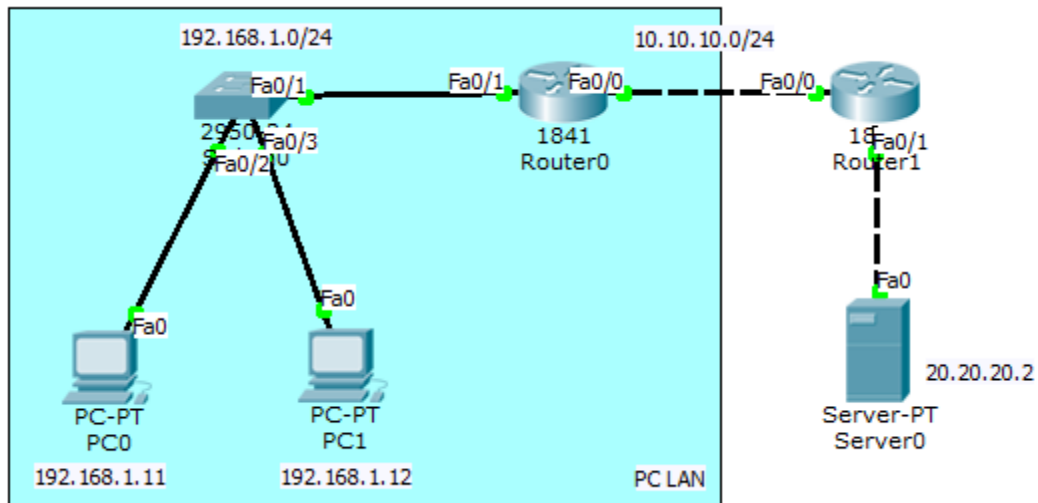

```
Router(config)#no access-list 10
```

Konfigurasi extended access list pada Router1 agar PC LAN dapat mengakses web server namun tidak bisa melakukan ping.

```
Router(config)#access-list 100 deny icmp 192.168.1.0 0.0.0.255 host 20.20.20.2 echo
Router(config)#access-list 100 permit ip any any
Router(config)#int fa0/1
Router(config-if)#ip access-group 100 out
```

Coba cek browser dan tes ping.

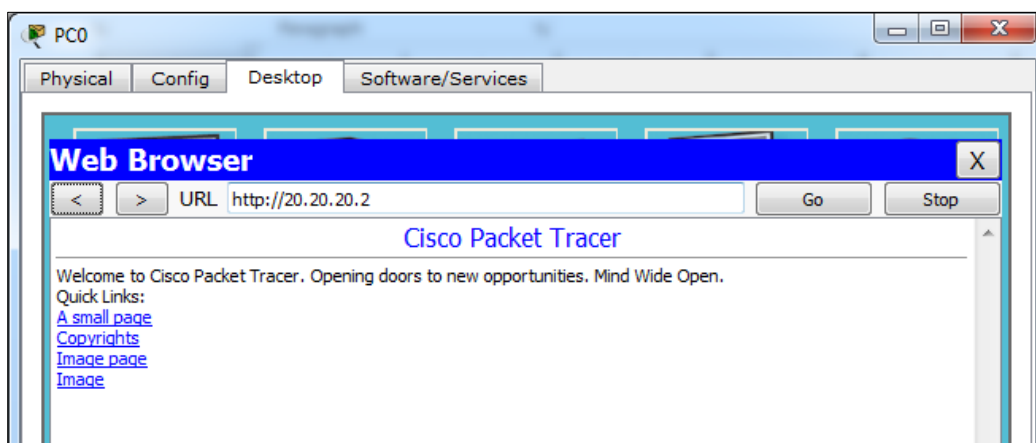

```
PC>ping 20.20.20.2
```

```
Pinging 20.20.20.2 with 32 bytes of data:
```

```
Reply from 10.10.10.2: Destination host unreachable.
Reply from 10.10.10.2: Destination host unreachable.
```

```
Reply from 10.10.10.2: Destination host unreachable.  
Reply from 10.10.10.2: Destination host unreachable.
```

```
Ping statistics for 20.20.20.2:  
Packets: Sent = 4, Received = 0, Lost = 4 (100% loss),
```

```
PC>
```

### Cek access list.

```
Router#show access-lists  
Standard IP access list 10  
deny 192.168.1.0 0.0.0.255 (64 match(es))  
permit any (5 match(es))  
Router#
```

## Standard ACL Syntax

```
! Legacy syntax
access-list <number> {permit | deny} <source> [log]

! Modern syntax
ip access-list standard {<number> | <name>}
 [<sequence>] {permit | deny} <source> [log]
```

## Actions

<b>permit</b>	Allow matched packets
<b>deny</b>	Deny matched packets
<b>remark</b>	Record a configuration comment
<b>evaluate</b>	Evaluate a reflexive ACL

## Extended ACL Syntax

```
! Legacy syntax
access-list <number> {permit | deny} <protocol> <source> [<ports>] <destination> [<ports>] [<options>]

! Modern syntax
ip access-list extended {<number> | <name>}
 [<sequence>] {permit | deny} <protocol> <source> [<ports>] <destination> [<ports>] [<options>]
```

### ACL Numbers

<b>1-99</b>	IP standard
<b>1300-1999</b>	IP extended
<b>100-199</b>	Protocol
<b>200-299</b>	DECnet
<b>400-499</b>	XNS
<b>500-599</b>	Extended XNS
<b>600-699</b>	Appletalk
<b>700-799</b>	Ethernet MAC
<b>800-899</b>	IPX standard
<b>900-999</b>	IPX extended
<b>1000-1099</b>	IPX SAP
<b>1100-1199</b>	MAC extended
<b>1200-1299</b>	IPX summary

### Source/Destination Definitions

<b>any</b>	Any address
<b>host &lt;address&gt;</b>	A single address
<b>&lt;network&gt; &lt;mask&gt;</b>	Any address matched by the wildcard mask

### IP Options

<b>dscp &lt;DSCP&gt;</b>	Match the specified IP DSCP
<b>fragments</b>	Check non-initial fragments
<b>option &lt;option&gt;</b>	Match the specified IP option
<b>precedence {0-7}</b>	Match the specified IP precedence
<b>ttl &lt;count&gt;</b>	Match the specified IP time to live (TTL)

### TCP/UDP Port Definitions

<b>eq &lt;port&gt;</b>	Equal to	<b>neq &lt;port&gt;</b>	Not equal to
<b>lt &lt;port&gt;</b>	Less than	<b>gt &lt;port&gt;</b>	Greater than
<b>range &lt;port&gt; &lt;port&gt;</b>	Matches a range of port numbers		

### Miscellaneous Options

<b>reflect &lt;name&gt;</b>	Create a reflexive ACL entry
<b>time-range &lt;name&gt;</b>	Enable rule only during the given time range

### Applying ACLs to Restrict Traffic

```
interface FastEthernet0/0
 ip access-group {<number> | <name>} {in | out}
```

### Troubleshooting

```
show access-lists [<number> | <name>]
show ip access-lists [<number> | <name>]
show ip access-lists interface <interface>
show ip access-lists dynamic
show ip interface [<interface>]
show time-range [<name>]
```

### Logging Options

<b>log</b>	Log ACL entry matches
<b>log-input</b>	Log matches including ingress interface and source MAC address

## Network Address Translation (NAT)

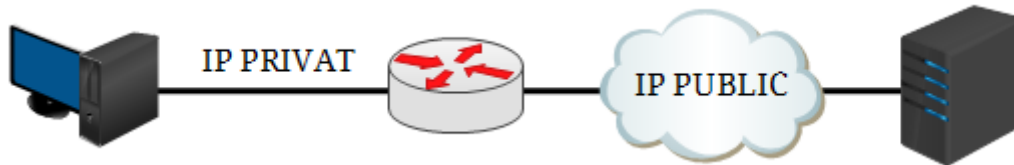

Network Access Translation (NAT) digunakan untuk mentranslasikan ip privat ke ip public atau sebaliknya. Misalkan ada server pada suatu perusahaan, selain bisa diakses secara local, perusahaan ingin server tersebut bisa diakses lewat internet. Maka server tersebut diberi ip public dan dikonfigurasi static NAT.

Dalam konfigurasi NAT, interface diset menjadi 2 kategori: inside dan outside.

- Inside = traffic yang masuk ke interface router dari local network.
- Outside = traffic yang keluar melalui interface router menuju destination/internet.

Ada beberapa tipe NAT.

- Static NAT, satu ip privat ditranslasikan ke satu ip public (one to one mapping)
- Dynamic NAT, Jumlah ip public yang disediakan harus sejumlah ip privat yang ditranslasikan NAT jenis ini jarang digunakan.
- Overloading/Port Address Translation (PAT), akses internet menggunakan 1 ip public. Ini yang banyak digunakan sekarang.

## Static NAT

Dalam static NAT, hanya 1 ip privat ditranslasikan ke 1 ip public. Artinya hanya 1 PC LAN yang dapat mengakses internet.

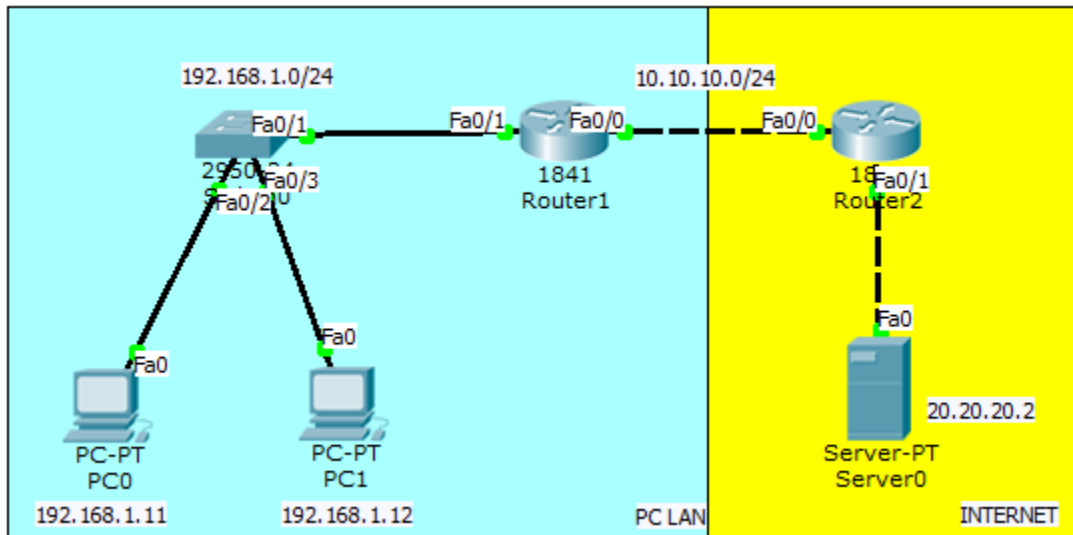

Konfigurasinya hampir sama dengan lab access list, namun tidak perlu dirouting karena nantinya akan menggunakan NAT.

Konfigurasi interface dan routing pada Router1.

```
Router(config)#int fa0/1
Router(config-if)#ip add 192.168.1.1 255.255.255.0
Router(config-if)#no sh
Router(config-if)#int fa0/0
Router(config-if)#ip add 10.10.10.1 255.255.255.0
Router(config-if)#no sh
```

Konfigurasi interface dan routing pada Router2.

```
Router(config)#int fa0/0
Router(config-if)#ip add 10.10.10.2 255.255.255.0
Router(config-if)#no sh
Router(config-if)#int fa0/1
Router(config-if)#ip add 20.20.20.1 255.255.255.0
Router(config-if)#no sh
```

Konfigurasi static NAT dan default route pada R1. PC LAN 192.168.1.11 akan ditranslasikan ke ip public 10.10.10.10.

```
Router(config)#ip nat inside source ?
  list    Specify access list describing local addresses
  static  Specify static local->global mapping
Router(config)#ip nat inside source static 192.168.1.11 10.10.10.10
Router(config)#int fa0/1
Router(config-if)#ip nat inside
Router(config-if)#int fa0/0
Router(config-if)#ip nat outside
Router(config)#ip route 0.0.0.0 0.0.0.0 fa0/0
```

**Ping static NAT melalui server dan sebaliknya. Alamat PC LAN tidak akan pernah dapat diping dari internet.**

```
SERVER>ping 10.10.10.10
```

```
Pinging 10.10.10.10 with 32 bytes of data:
```

```
Reply from 10.10.10.10: bytes=32 time=11ms TTL=126  
Reply from 10.10.10.10: bytes=32 time=0ms TTL=126  
Reply from 10.10.10.10: bytes=32 time=0ms TTL=126  
Reply from 10.10.10.10: bytes=32 time=11ms TTL=126
```

```
Ping statistics for 10.10.10.10:
```

```
    Packets: Sent = 4, Received = 4, Lost = 0 (0% loss),  
Approximate round trip times in milli-seconds:  
    Minimum = 0ms, Maximum = 11ms, Average = 5ms
```

```
SERVER>ping 192.168.1.11
```

```
Pinging 192.168.1.11 with 32 bytes of data:
```

```
Reply from 20.20.20.1: Destination host unreachable.  
Reply from 20.20.20.1: Destination host unreachable.  
Request timed out.  
Reply from 20.20.20.1: Destination host unreachable.
```

```
Ping statistics for 192.168.1.11:
```

```
    Packets: Sent = 4, Received = 0, Lost = 4 (100% loss),
```

```
SERVER>
```

```
PC>ping 20.20.20.2
```

```
Pinging 20.20.20.2 with 32 bytes of data:
```

```
Reply from 20.20.20.2: bytes=32 time=12ms TTL=126  
Reply from 20.20.20.2: bytes=32 time=0ms TTL=126  
Reply from 20.20.20.2: bytes=32 time=0ms TTL=126  
Reply from 20.20.20.2: bytes=32 time=0ms TTL=126
```

```
Ping statistics for 20.20.20.2:
```

```
    Packets: Sent = 4, Received = 4, Lost = 0 (0% loss),  
Approximate round trip times in milli-seconds:  
    Minimum = 0ms, Maximum = 12ms, Average = 3ms
```

```
PC>
```

## Overloading/Port Address Translation (PAT)

PAT digunakan agar banyak PC local dapat mengakses internet secara bersama-sama hanya dengan menggunakan 1 ip public.

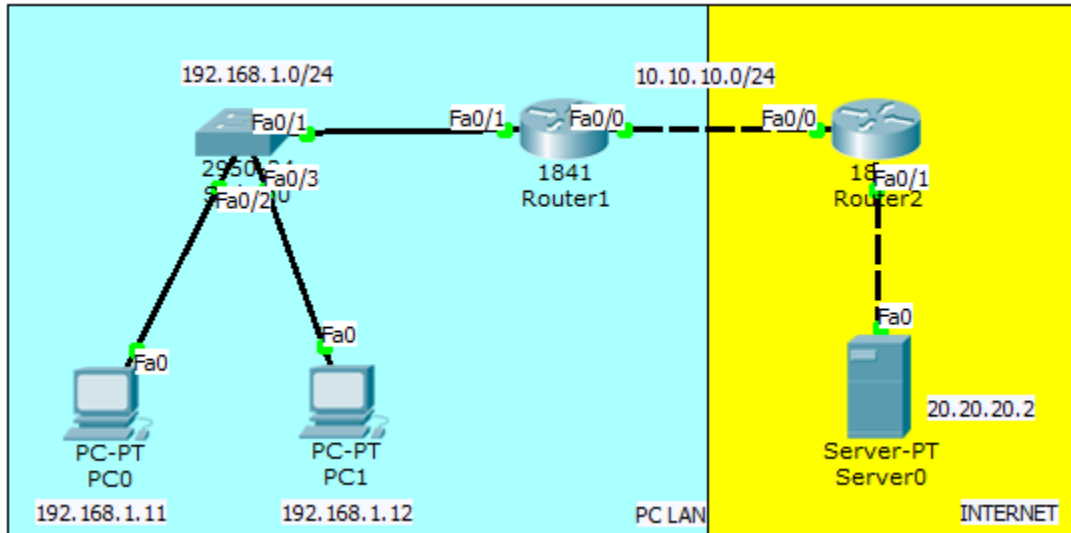

Lanjutan lab sebelumnya. Hapus dahulu konfigurasi static NAT yang telah dibuat.

```
Router(config)#no ip nat inside source static 192.168.1.11 10.10.10.10
```

Buat access list untuk mendefinisikan network yang akan ditranslasikan dan konfigurasi dynamic nat overload pada R1.

```
Router(config)#access-list 1 permit 192.168.1.0 0.0.0.255
Router(config)#ip nat inside source list ?
<1-199> Access list number for local addresses
WORD Access list name for local addresses
Router(config)#ip nat inside source list 1 interface fa0/0 overload
```

Sekarang ping web server melalui PC0 dan PC1 pastikan reply.

```
PC>ping 20.20.2.2
```

```
Pinging 20.20.2.2 with 32 bytes of data:
```

```
Reply from 20.20.2.2: bytes=32 time=12ms TTL=126
Reply from 20.20.2.2: bytes=32 time=0ms TTL=126
Reply from 20.20.2.2: bytes=32 time=0ms TTL=126
Reply from 20.20.2.2: bytes=32 time=0ms TTL=126
```

```
Ping statistics for 20.20.2.2:
```

```
Packets: Sent = 4, Received = 4, Lost = 0 (0% loss),
Approximate round trip times in milli-seconds:
Minimum = 0ms, Maximum = 12ms, Average = 3ms
```

```
PC>
```

## Example Topology

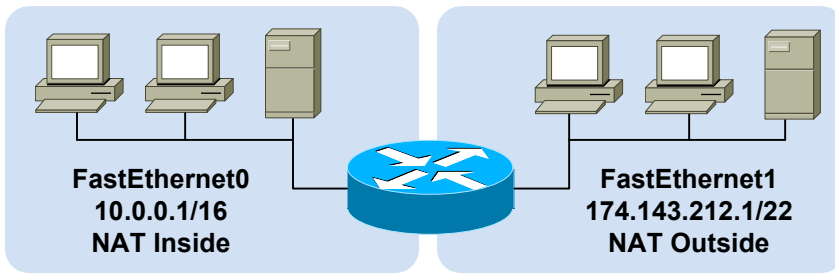

## Address Classification

<b>Inside Local</b>	An actual address assigned to an inside host
<b>Inside Global</b>	An inside address seen from the outside
<b>Outside Global</b>	An actual address assigned to an outside host
<b>Outside Local</b>	An outside address seen from the inside

## NAT Boundary Configuration

```
interface FastEthernet0
ip address 10.0.0.1 255.255.0.0
ip nat inside
!
interface FastEthernet1
ip address 174.143.212.1 255.255.252.0
ip nat outside
```

		Perspective	
		Local	Global
Location	Inside	Inside Local	Inside Global
	Outside	Outside Local	Outside Global

## Static Source Translation

```
! One line per static translation
ip nat inside source static 10.0.0.19 192.0.2.1
ip nat inside source static 10.0.1.47 192.0.2.2
ip nat outside source static 174.143.212.133 10.0.0.47
ip nat outside source static 174.143.213.240 10.0.2.181
```

## Terminology

### NAT Pool

A pool of IP addresses to be used as inside global or outside local addresses in translations

### Port Address Translation (PAT)

An extension to NAT that translates information at layer four and above, such as TCP and UDP port numbers; dynamic PAT configurations include the **overload** keyword

### Extendable Translation

The **extendable** keyword must be appended when multiple overlapping static translations are configured

## Dynamic Source Translation

```
! Create an access list to match inside local addresses
access-list 10 permit 10.0.0.0 0.0.255.255
!
! Create NAT pool of inside global addresses
ip nat pool MyPool 192.0.2.1 192.0.2.254 prefix-length 24
!
! Combine them with a translation rule
ip nat inside source list 10 pool MyPool
!
! Dynamic translations can be combined with static entries
ip nat inside source static 10.0.0.42 192.0.2.42
```

## Special NAT Pool Types

**Rotary** Used for load balancing

**Match-Host** Preserves the host portion of the address after translation

## Port Address Translation (PAT)

```
! Static layer four port translations
ip nat inside source static tcp 10.0.0.3 8080 192.0.2.1 80
ip nat inside source static udp 10.0.0.14 53 192.0.2.2 53
ip nat outside source static tcp 174.143.212.4 23 10.0.0.8 23
!
! Dynamic port translation with a pool
ip nat inside source list 11 pool MyPool overload
!
! Dynamic translation with interface overloading
ip nat inside source list 11 interface FastEthernet1 overload
```

## Troubleshooting

```
show ip nat translations [verbose]
show ip nat statistics
clear ip nat translations
```

## NAT Translations Tuning

```
ip nat translation tcp-timeout <seconds>
ip nat translation udp-timeout <seconds>
ip nat translation max-entries <number>
```

## Inside Destination Translation

```
! Create a rotary NAT pool
ip nat pool LoadBalServers 10.0.99.200 10.0.99.203 prefix-length 24 type rotary
!
! Enable load balancing across inside hosts for incoming traffic
ip nat inside destination list 12 pool LoadBalServers
```



# High Availability

High Availability digunakan dengan maksud redundancy yaitu sebagai menggunakan beberapa router, yang satu menjadi link utama dan yang lain sebagai backup. Satu virtual gateway akan dipasang di PC local sehingga ketika pindah router tidak perlu mengeset gateway lagi.

## HSRP

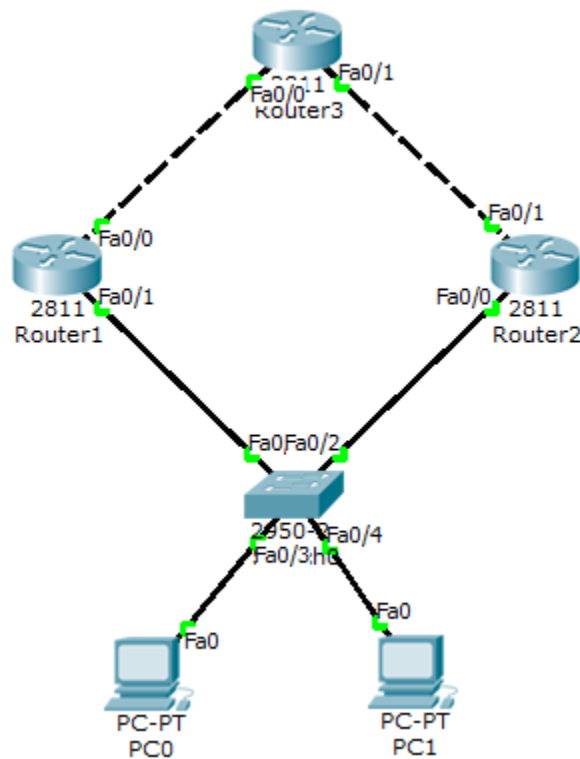

Konfigurasi routing seperti biasa pada ketika

```
Router(config)#hostname Router1
Router1(config)#int fa0/0
Router1(config-if)#ip add 13.13.13.1 255.255.255.0
Router1(config-if)#no sh

Router1(config-if)#int fa0/1
Router1(config-if)#ip add 12.12.12.1 255.255.255.0
Router1(config-if)#no sh

Router1(config-if)#router eigrp 10
Router1(config-router)#network 13.13.13.1 0.0.0.255
Router1(config-router)#network 12.12.12.1 0.0.0.255
Router1(config-router)#passive-interface fa0/1
Router1(config-router)#no auto-summary
```

```

Router(config)#hostname Router2
Router2(config)#int fa0/1
Router2(config-if)#ip add 23.23.23.2 255.255.255.0
Router2(config-if)#no sh

Router2(config-if)#int fa0/0
Router2(config-if)#ip add 12.12.12.2 255.255.255.0
Router2(config-if)#no sh

Router2(config-if)#router eigrp 10
Router2(config-router)#network 23.23.23.2 0.0.0.255
Router2(config-router)#network 12.12.12.2 0.0.0.255
Router2(config-router)#passive-interface fa0/0
Router2(config-router)#no auto-summary

```

```

Router(config)#hostname Router3
Router3(config)#int lo0

Router3(config-if)#ip add 3.3.3.3 255.255.255.255
Router3(config-if)#int fa0/1
Router3(config-if)#ip add 23.23.23.3 255.255.255.0
Router3(config-if)#no sh

Router3(config-if)#int fa0/0
Router3(config-if)#ip add 13.13.13.3 255.255.255.0
Router3(config-if)#no sh

Router3(config-if)#router eigrp 10
Router3(config-router)#network 23.23.23.3 0.0.0.255
Router3(config-router)#network 13.13.13.3 0.0.0.255
Router3(config-router)#network 3.3.3.3 0.0.0.0
Router3(config-router)#no auto-summary

```

**Pastikan Router1 dan Router2 dapat melakukan ping ke 3.3.3.3 baru lakukan konfigurasi HSRP.**

```

Router1(config)#int fa0/1
Router1(config-if)#standby ?
  <0-4095>  group number
  ip       Enable HSRP and set the virtual IP address
  ipv6    Enable HSRP IPv6
  preempt  Overthrow lower priority Active routers
  priority Priority level
  track    Priority Tracking
Router1(config-if)#standby 1 ip 12.12.12.12
Router1(config-if)#standby 1 preempt
%HSRP-6-STATECHANGE: FastEthernet0/1 Grp 1 state Speak -> Standby

%HSRP-6-STATECHANGE: FastEthernet0/1 Grp 1 state Standby -> Active
Router1(config-if)#standby 1 priority 105
Router1(config-if)#standby 1 track fa0/0

```

```

Router2(config)#int fa0/0
Router2(config-if)#standby 1 ip 12.12.12.12
Router2(config-if)#standby preempt

```

```
%HSRP-6-STATECHANGE: FastEthernet0/0 Grp 1 state Speak -> Standby
```

## Konfigurasi di PC.

```
PC0 IP:12.12.12.100/24 GATEWAY:12.12.12.12  
PC1 IP:12.12.12.101/24 GATEWAY:12.12.12.12
```

## Ping dan trace dari PC ke 3.3.3.3.

```
PC>ping 3.3.3.3  
  
Pinging 3.3.3.3 with 32 bytes of data:  
  
Reply from 3.3.3.3: bytes=32 time=1ms TTL=254  
Reply from 3.3.3.3: bytes=32 time=1ms TTL=254  
Reply from 3.3.3.3: bytes=32 time=1ms TTL=254  
Reply from 3.3.3.3: bytes=32 time=0ms TTL=254  
  
Ping statistics for 3.3.3.3:  
    Packets: Sent = 4, Received = 4, Lost = 0 (0% loss),  
Approximate round trip times in milli-seconds:  
    Minimum = 0ms, Maximum = 1ms, Average = 0ms  
  
PC>tracert 3.3.3.3  
  
Tracing route to 3.3.3.3 over a maximum of 30 hops:  
  
  0  1 ms    1 ms    0 ms    12.12.12.1  
  1  1 ms    1 ms    0 ms    3.3.3.3  
  
Trace complete.  
  
PC>
```

## Cek standby pada Router1 dan Router2.

```
Router1#show standby br  
          P indicates configured to preempt.  
          |  
Interface  Grp  Pri P State      Active          Standby          Virtual IP  
Fa0/1      1    105 P Active    local          12.12.12.2      12.12.12.12  
Router1#
```

```
Router2#show standby br  
          P indicates configured to preempt.  
          |  
Interface  Grp  Pri P State      Active          Standby          Virtual IP  
Fa0/0      1    100 Standby  12.12.12.1    local          12.12.12.12  
Router2#
```

```
Router2(config)#int fa0/0  
Router2(config-if)#standby 1 ip 12.12.12.12  
Router2(config-if)#standby preempt  
%HSRP-6-STATECHANGE: FastEthernet0/0 Grp 1 state Speak -> Standby
```

Protocols	Attributes		
<b>Hot Standby Router Protocol (HSRP)</b> Provides default gateway redundancy using one active and one standby router; standardized but licensed by Cisco Systems	<b>HSRP</b>	<b>VRRP</b>	<b>GLBP</b>
<b>Virtual Router Redundancy Protocol (VRRP)</b> An open-standard alternative to Cisco's HSRP, providing the same functionality	<b>Standard</b>	RFC 2281	RFC 3768
<b>Gateway Load Balancing Protocol (GLBP)</b> Supports arbitrary load balancing in addition to redundancy across gateways; Cisco proprietary	<b>Load Balancing</b>	No	No
	<b>IPv6 Support</b>	Yes	No
	<b>Transport</b>	UDP/1985	IP/112
	<b>Default Priority</b>	100	100
	<b>Default Hello</b>	3 sec	1 sec
	<b>Multicast Group</b>	224.0.0.2	224.0.0.18
			224.0.0.102

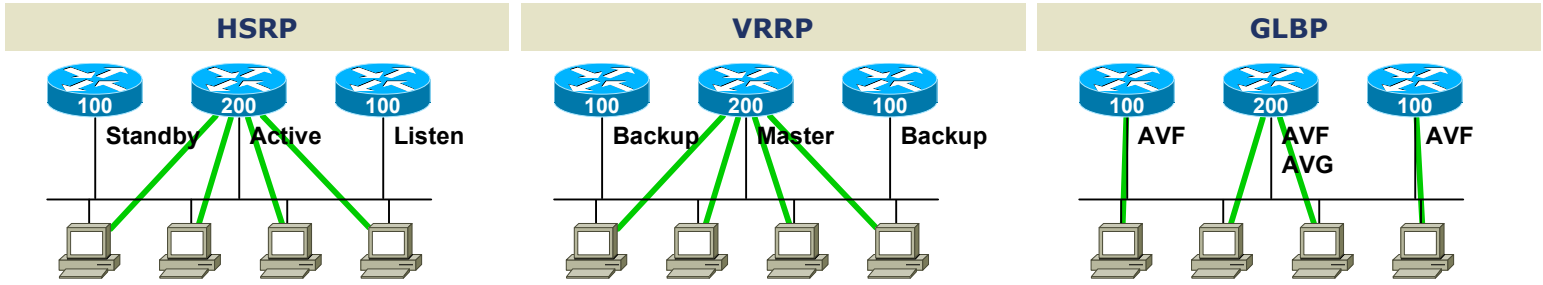

## HSRP Configuration

```
interface FastEthernet0/0
ip address 10.0.1.2 255.255.255.0
standby version {1 | 2}
standby 1 ip 10.0.1.1
standby 1 timers <hello> <dead>
standby 1 priority <priority>
standby 1 preempt
standby 1 authentication md5 key-string <password>
standby 1 track <interface> <value>
standby 1 track <object> decrement <value>
```

## VRRP Configuration

```
interface FastEthernet0/0
ip address 10.0.1.2 255.255.255.0
vrrp 1 ip 10.0.1.1
vrrp 1 timers {advertise <hello> | learn}
vrrp 1 priority <priority>
vrrp 1 preempt
vrrp 1 authentication md5 key-string <password>
vrrp 1 track <object> decrement <value>
```

## GLBP Configuration

```
interface FastEthernet0/0
ip address 10.0.1.2 255.255.255.0
glbp 1 ip 10.0.1.1
glbp 1 timers <hello> <dead>
glbp 1 timers redirect <redirect> <time-out>
glbp 1 priority <priority>
glbp 1 preempt
glbp 1 forwarder preempt
glbp 1 authentication md5 key-string <password>
glbp 1 load-balancing <method>
glbp 1 weighting <weight> lower <lower> upper <upper>
glbp 1 weighting track <object> decrement <value>
```

## HSRP/GLBP Interface States

- Speak** · Gateway election in progress
- Active** · Active router/VG
- Standby** · Backup router/VG
- Listen** · Not the active router/VG

## VRRP Interface States

- Master** · Acting as the virtual router
- Backup** · All non-master routers

## GLBP Roles

- Active Virtual Gateway (AVG)**  
Answers for the virtual router and assigns virtual MAC addresses to group members
- Active Virtual Forwarder (AVF)**  
All routers which forward traffic for the group

## GLBP Load Balancing

- Round-Robin (default)**  
The AVG answers host ARP requests for the virtual router with the next router in the cycle
- Host-Dependent**  
Round-robin cycling is used while a consistent AVF is maintained for each host
- Weighted**  
Determines the proportionate share of hosts handled by each AVF

## Troubleshooting

```
show standby [brief]   show vrrp [brief]
show glbp [brief]     show track [brief]
```

# IPv6

- IPv6 Basic Link-Local
- IPv6 Basic Global Unicast
  - IPv6 Basic EUI-64
- IPv6 Static Routing
  - IPv6 RIPnG
  - IPv6 EIGRP
  - IPv6 OSPFv3
- IPv6 IPv6IP Tunneling
- IPv6 GRE IP Tunneling
  - IPv6 Tunnel 6to4
  - IPv6 Tunnel ISATAP
- IPv6 Tunnel Auto-Tunnel

# IPv6 Overview

Pengguna internet berkembang sangat pesat sehingga space IPv4 yang tersedia juga semakin sedikit. Apalagi dengan banyaknya perangkat seperti telepon dan tablet yang butuh koneksi internet juga turut mengurangi space IPv4. Solusinya adalah dengan IPv6 yang mempunyai space ip yang jauh lebih banyak.

Masalahnya adalah IPv4 berbeda dengan IPv6 sehingga banyak protocol yang tidak compatible satu sama lain. Migrasi dari IPv4 ke IPv6 sudah banyak dilakukan.

Berikut perbandingan jumlah IPv4 dan IPv6.

IPv4 32bit =  $2^3$  = 4.294.967.296

IPv6 128bit =  $2^{128}$  = 340.282.366.920.938.463.463.374.607.431.768.211.456

- Dengan banyaknya space yang disediakan IPv6 maka tidak perlu lagi menggunakan Network Address Translation (NAT) dan Port Address Translation (PAT).
- Dari segi size header, IPv6 mempunyai header yang lebih kecil dibanding IPv4.
- IPv6 terdiri dari 16bit hexadecimal dan case-insensitive yang terbagi menjadi 8 field, tidak seperti IPv4 yang terdiri dari 12bit dan terbagi menjadi 4 oktet.
- Jika dalam IPv4 ada namanya oktet, di IPv6 ada namanya field. Pada IPv6 prefixnya sampai 128. Contohnya: 0000:360B:0000:0000:0020:875B:131B/64.

## Meringkas IPv6

Aslinya : 2541:0000:360B:0000:0020:875B:131B/64

Jika ada 0000 baik berjejer atau tidak, dapat diwakili tanda colon 2 (::). Syaratnya semua harus 0, tidak boleh ada angka selain 0.

Diringkas : 2541:0000:360B::0020:875B:131B/64

Klo sudah ada :: maka jika ada 0000 tidak bisa diwakili :: lagi karena hanya ada satu :: dalam satu IPv6. 0000 bisa diwakili hanya dengan 0 saja.

Selain itu jika ada field yang depannya (sisi kirinya) adalah 0, maka 0 bisa dihilangkan.

Diringkas lagi : 2541:0:360B::20:875B:131B/64

Dalam IPv6 tidak ada broadcast. Adanya unicast, multicast dan anycast.

**Unicast**, unicast dalam IPv6 sama dengan IPv4. Kelebihannya, IPv6 dapat memberikan lebih dari 1 alamat pada 1 interface. Keren kan?

**Multicast**, pada IPv6, broadcast digantikan oleh multicast karena memang tidak ada broadcast dalam IPv6.

**Anycast**, dalam IPv6 beberapa host dan router dapat diberi ip yang sama. Misalkan kita punya beberapa web server dengan ip anycast yang sama. Dengan cara tersebut, kita bisa mengarahkan host yang mengakses web server tadi untuk di route ke web server terdekat.

## Jenis-Jenis IP IPv6

**Unique Local**, sama dengan IP private pada IPv4. IP private digunakan untuk network local dan bukan untuk internet. IP network yang digunakan adalah FD00::/8.

**Link Local**, digunakan untuk mengirim dan menerima packet IPv6 dalam sebuah single subnet. Tiap perangkat yang memakai IPv6 akan mempunyai alamat link local secara otomatis pada interfacenya dan mempunyai link local scope atau jangkauan link local, artinya packet tidak akan meninggalkan link local. Packet yang dikirim ke destination tertentu akan tetap berada dalam link local dan tidak diforward ke subnet lain oleh router. Link Local menggunakan IP network FE80::/10.

Link Local digunakan sebagai RS (Router Solicitation) and RA (Router Advertisement), untuk network discovery (sama seperti ARP) dan digunakan sebagai next-hop untuk ip route.

**Global Unicast**, sama seperti ip publik untuk internet. IP network yang digunakan adalah 2000::/3.

**Unspecified**, alamat ini digunakan ketika host tidak bisa menggunakan IPv6, menggunakan ::/128

**Loopback** yang digunakan untuk software testing seperti 127.0.0.1. Loopback menggunakan ip ::1/128.

**Site Local**. Site local dulunya digunakan sebagai ip private, sekarang sudah tidak digunakan. IP site local adalah FEC0::/10.

## IPv6 Basic Link-Local



Secara default IPv6 tidak aktif, untuk mengaktifkan ketikkan perintah unicast-routing.

```
R1(config)#ipv6 unicast-routing
```

Setiap kali mengkonfigurasi IPv6 pada interface, link-local akan otomatis terbuat.

```
R1(config-if)#do sh ipv6 int fa0/0
FastEthernet0/0 is administratively down, line protocol is down
  IPv6 is enabled, link-local address is FE80::C201:9FF:FED0:0 [TEN]
  No Virtual link-local address(es):
  No global unicast address is configured
  Joined group address(es):
    FF02::1
    FF02::2
  MTU is 1500 bytes
  ICMP error messages limited to one every 100 milliseconds
  ICMP redirects are enabled
  ICMP unreachables are sent
  ND DAD is enabled, number of DAD attempts: 1
  ND reachable time is 30000 milliseconds
  ND advertised reachable time is 0 milliseconds
  ND advertised retransmit interval is 0 milliseconds
  ND router advertisements are sent every 200 seconds
  ND router advertisements live for 1800 seconds
  ND advertised default router preference is Medium
  Hosts use stateless autoconfig for addresses.
R1(config-if)#
```

Bisa juga dengan perintah berikut.

```
R2(config)#int fa0/0
R2(config-if)#ipv6 address autoconfig

R2(config)#do show ipv6 int fa0/0
FastEthernet0/0 is administratively down, line protocol is down
  IPv6 is enabled, link-local address is FE80::C202:CFF:FED8:0 [TEN]
  No Virtual link-local address(es):
  No global unicast address is configured
  Joined group address(es):
    FF02::1
    FF02::2
  MTU is 1500 bytes
  ICMP error messages limited to one every 100 milliseconds
  ICMP redirects are enabled
  ICMP unreachables are sent
  ND DAD is enabled, number of DAD attempts: 1
  ND reachable time is 30000 milliseconds
```



```
ND advertised reachable time is 0 milliseconds
ND advertised retransmit interval is 0 milliseconds
ND router advertisements are sent every 200 seconds
ND router advertisements live for 1800 seconds
ND advertised default router preference is Medium
Hosts use stateless autoconfig for addresses.
R2(config)#
```

## IPv6 Basic Global Unicast



```
R1(config)#int fa0/0
R1(config-if)#ipv6 address 12::1/126
R1(config-if)#no sh
*Mar 1 00:22:30.687: %LINK-3-UPDOWN: Interface FastEthernet0/0, changed
state to up
*Mar 1 00:22:31.687: %LINEPROTO-5-UPDOWN: Line protocol on Interface
FastEthernet0/0, changed state to up
```

```
R2(config)#int fa0/0
R2(config-if)#ipv6 add 12::2/126
R2(config-if)#no sh
*Mar 1 00:21:23.063: %LINK-3-UPDOWN: Interface FastEthernet0/0, changed
state to up
*Mar 1 00:21:24.063: %LINEPROTO-5-UPDOWN: Line protocol on Interface
FastEthernet0/0, changed state to up
```

### Cek ping.

```
R2(config-if)#do ping 12::1

Type escape sequence to abort.
Sending 5, 100-byte ICMP Echos to 12::1, timeout is 2 seconds:
!!!!
Success rate is 100 percent (5/5), round-trip min/avg/max = 32/54/104 ms
R2(config-if)#
```

## IPv6 Basic EUI-64



Untuk konfigurasi otomatis.

```
R2(config-if)#int fa0/1
R2(config-if)#ipv6 address 23::/64 eui-64
R2(config-if)#no sh
*Mar 1 00:25:46.951: %LINK-3-UPDOWN: Interface FastEthernet0/1, changed
state to up
*Mar 1 00:25:47.951: %LINEPROTO-5-UPDOWN: Line protocol on Interface
FastEthernet0/1, changed state to up
```

```
R3(config)#int fa0/1
R3(config-if)#ipv6 address 23::/64 eui-64
R3(config-if)#no sh
*Mar 1 00:24:13.739: %LINK-3-UPDOWN: Interface FastEthernet0/1, changed
state to up
*Mar 1 00:24:14.739: %LINEPROTO-5-UPDOWN: Line protocol on Interface
FastEthernet0/1, changed state to up
```

Cek interface R2 dan R3.

```
R2(config-if)#do sh ipv6 int br
FastEthernet0/0          [up/up]
    FE80::C202:CFF:FED8:0
    12::2
FastEthernet0/1          [up/up]
    FE80::C202:CFF:FED8:1
    23::C202:CFF:FED8:1
Serial1/0                 [administratively down/down]
Serial1/1                 [administratively down/down]
Serial1/2                 [administratively down/down]
Serial1/3                 [administratively down/down]
R2(config-if)#
```

```
R3(config-if)#do sh ipv6 int br
FastEthernet0/0          [administratively down/down]
FastEthernet0/1          [up/up]
    FE80::C203:3FF:FEA8:1
    23::C203:3FF:FEA8:1
Serial1/0                 [administratively down/down]
Serial1/1                 [administratively down/down]
Serial1/2                 [administratively down/down]
Serial1/3                 [administratively down/down]
R3(config-if)#
```

## Cek ping ke R2.

```
Type escape sequence to abort.  
Sending 5, 100-byte ICMP Echos to 23::C202:CFF:FED8:1, timeout is 2 seconds:  
!!!!  
Success rate is 100 percent (5/5), round-trip min/avg/max = 28/56/104 ms  
R3(config-if)#
```

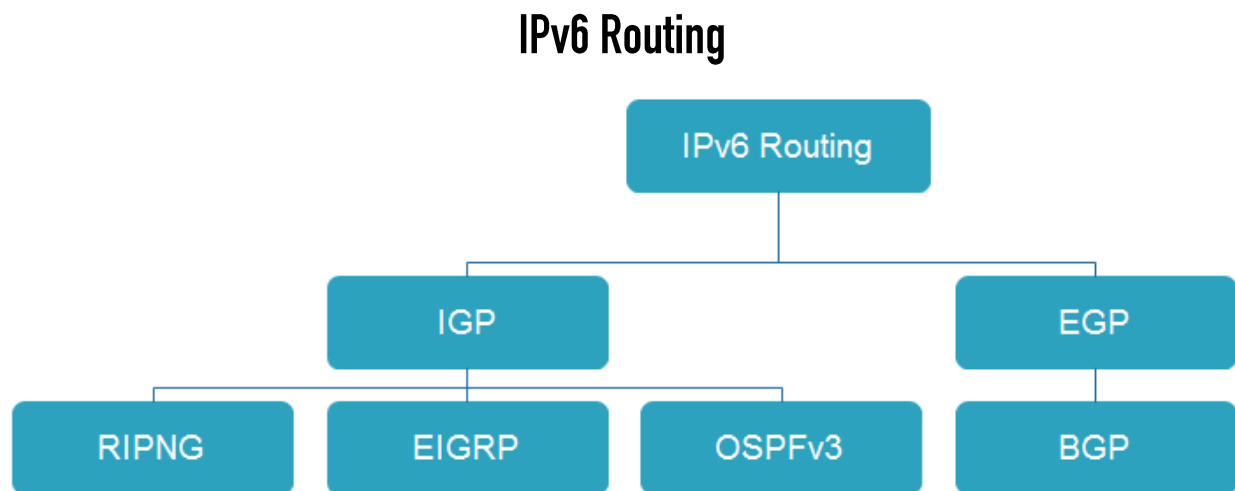

## IPv6 Static Routing



Pakai topologi sebelumnya. Cek interface router untuk menentukan destination dan next-hop.

```
R1#sh ipv6 int br
FastEthernet0/0      [up/up]
    FE80::C201:9FF:FED0:0
    12::1
FastEthernet0/1      [administratively down/down]
Serial1/0            [administratively down/down]
Serial1/1            [administratively down/down]
Serial1/2            [administratively down/down]
Serial1/3            [administratively down/down]
R1#
```

```
R2#sh ipv6 int br
FastEthernet0/0      [up/up]
    FE80::C202:CFF:FED8:0
    12::2
FastEthernet0/1      [up/up]
    FE80::C202:CFF:FED8:1
    23::C202:CFF:FED8:1
Serial1/0            [administratively down/down]
Serial1/1            [administratively down/down]
Serial1/2            [administratively down/down]
Serial1/3            [administratively down/down]
R2#
```

```
R3#sh ipv6 int br
FastEthernet0/0      [administratively down/down]
FastEthernet0/1      [up/up]
    FE80::C203:3FF:FEA8:1
    23::C203:3FF:FEA8:1
Serial1/0            [administratively down/down]
Serial1/1            [administratively down/down]
Serial1/2            [administratively down/down]
Serial1/3            [administratively down/down]
R3#
```

Konfigurasi static routing pada IPv6 hampir sama dengan IPv4.

```
R1(config)# ipv6 route 23::/64 12::2
R3(config)# ipv6 route 12::/126 23::C202:CFF:FED8:1
```

## Cek tabel routing dan tes ping.

```
R1#sh ipv6 route
IPv6 Routing Table - 4 entries
Codes: C - Connected, L - Local, S - Static, R - RIP, B - BGP
       U - Per-user Static route, M - MIPv6
       I1 - ISIS L1, I2 - ISIS L2, IA - ISIS interarea, IS - ISIS summary
       O - OSPF intra, OI - OSPF inter, OE1 - OSPF ext 1, OE2 - OSPF ext 2
       ON1 - OSPF NSSA ext 1, ON2 - OSPF NSSA ext 2
       D - EIGRP, EX - EIGRP external
C    12::/126 [0/0]
     via ::, FastEthernet0/0
L    12::1/128 [0/0]
     via ::, FastEthernet0/0
S    23::/64 [1/0]
     via 12::2
L    FF00::/8 [0/0]
     via ::, Null0
R1#ping 23::C203:3FF:FEA8:1

Type escape sequence to abort.
Sending 5, 100-byte ICMP Echos to 23::C203:3FF:FEA8:1, timeout is 2 seconds:
!!!!
Sukses
```

```
R3(config)#do sho ipv6 route
IPv6 Routing Table - 4 entries
Codes: C - Connected, L - Local, S - Static, R - RIP, B - BGP
       U - Per-user Static route, M - MIPv6
       I1 - ISIS L1, I2 - ISIS L2, IA - ISIS interarea, IS - ISIS summary
       O - OSPF intra, OI - OSPF inter, OE1 - OSPF ext 1, OE2 - OSPF ext 2
       ON1 - OSPF NSSA ext 1, ON2 - OSPF NSSA ext 2
       D - EIGRP, EX - EIGRP external
S    12::/126 [1/0]
     via 23::C202:CFF:FED8:1
C    23::/64 [0/0]
     via ::, FastEthernet0/1
L    23::C203:3FF:FEA8:1/128 [0/0]
     via ::, FastEthernet0/1
L    FF00::/8 [0/0]
     via ::, Null0
R3(config)#do ping 12::1

Type escape sequence to abort.
Sending 5, 100-byte ICMP Echos to 12::1, timeout is 2 seconds:
!!!!
Success rate is 100 percent (5/5), round-trip min/avg/max = 64/74/84 ms
R3(config)#
```

Selain menggunakan ip next-hop, konfigurasi static routing juga dapat menggunakan interface next-hop. Khusus IPv6, harus disertakan link localnya.

Hapus dulu static routing sebelumnya.

```
R1(config)#no ipv6 route 23::/64 12::2
R3(config)#no ipv6 route 12::/126 23::C202:CFF:FED8:1
```

```

R1(config)#ipv6 route 23::/64 FastEthernet 0/0
R1(config)#do ping 23::C203:3FF:FEA8:1

Type escape sequence to abort.
Sending 5, 100-byte ICMP Echos to 23::C203:3FF:FEA8:1, timeout is 2 seconds:
.....
Success rate is 0 percent (0/5)
R1(config)#

```

### Ping gagal karena belum disertakan link local.

```

R1(config)#no ipv6 route 23::/64 FastEthernet 0/0
R1(config)#ipv6 route 23::/64 FastEthernet 0/0 FE80::C202:CFF:FED8:0
R1(config)#do ping 23::C203:3FF:FEA8:1

Type escape sequence to abort.
Sending 5, 100-byte ICMP Echos to 23::C203:3FF:FEA8:1, timeout is 2 seconds:
!!!!
Success rate is 100 percent (5/5), round-trip min/avg/max = 72/85/108 ms
R1(config)#

```

### Sekarang konfigurasi routing static pada R3.

```

R3(config)#ipv6 route 12::/126 FastEthernet 0/1 FE80::C202:CFF:FED8:1
R3(config)#do ping 12::1

Type escape sequence to abort.
Sending 5, 100-byte ICMP Echos to 12::1, timeout is 2 seconds:
!!!!
Success rate is 100 percent (5/5), round-trip min/avg/max = 56/68/92 ms
R3(config)#

```

## IPv6 RIPnG



Masih memakai topologi sebelumnya, hapus dulu ipv6 route. Masukkan konfigurasi RIPnG.

```

R1(config)#ipv6 unicast-routing
R1(config)#int fa0/0
R1(config-if)#ipv6 rip ?
WORD User selected string identifying this RIP process

R1(config-if)#ipv6 rip 17 ?
default-information Configure handling of default route
enable Enable/disable RIP routing

```

```
metric-offset      Adjust default metric increment
summary-address    Configure address summarization
```

```
R1(config-if)#ipv6 rip 17 enable
```

```
R2(config)#ipv6 unicast-routing
R2(config)#int fa0/0
R2(config-if)#ipv6 rip 17 enable
R2(config-if)#int fa0/1
R2(config-if)#ipv6 rip 17 enable
```

```
R3(config)#ipv6 unicast-routing
R3(config)#int fa0/1
R3(config-if)#ipv6 rip 17 enable
```

### Cek tabel routing dan tes ping.

```
R3#sh ipv6 route
IPv6 Routing Table - 4 entries
Codes: C - Connected, L - Local, S - Static, R - RIP, B - BGP
       U - Per-user Static route, M - MIPv6
       I1 - ISIS L1, I2 - ISIS L2, IA - ISIS interarea, IS - ISIS summary
       O - OSPF intra, OI - OSPF inter, OE1 - OSPF ext 1, OE2 - OSPF ext 2
       ON1 - OSPF NSSA ext 1, ON2 - OSPF NSSA ext 2
       D - EIGRP, EX - EIGRP external
R   12::/126 [120/2]
    via FE80::C202:CFE:FED8:1, FastEthernet0/1
C   23::/64 [0/0]
    via ::, FastEthernet0/1
L   23::C203:3FE:FEA8:1/128 [0/0]
    via ::, FastEthernet0/1
L   FF00::/8 [0/0]
    via ::, Null0
R3#ping 12::1

Type escape sequence to abort.
Sending 5, 100-byte ICMP Echos to 12::1, timeout is 2 seconds:
!!!!
Success rate is 100 percent (5/5), round-trip min/avg/max = 52/92/160 ms
R3#
```

### Cek protocol yang sedang bekerja.

```
R1#sh ipv6 protocols
IPv6 Routing Protocol is "connected"
IPv6 Routing Protocol is "static"
IPv6 Routing Protocol is "rip 17"
  Interfaces:
    FastEthernet0/0
  Redistribution:
    None
R1#sh ipv6 rip 17
RIP process "17", port 521, multicast-group FF02::9, pid 238
  Administrative distance is 120. Maximum paths is 16
  Updates every 30 seconds, expire after 180
  Holddown lasts 0 seconds, garbage collect after 120
```

```

Split horizon is on; poison reverse is off
Default routes are not generated
Periodic updates 34, trigger updates 0
Interfaces:
  FastEthernet0/0
Redistribution:
  None
R1#

```

## IPv6 EIGRP



Hapus dulu RIPnG nya.

```

R1(config)#no ipv6 router rip 17
R2(config)#no ipv6 router rip 17
R3(config)#no ipv6 router rip 17

```

Tambahkan interface loopback sebagai identitas dan agar lebih mudah diping.

```

R1(config-rtr)#int lo0
R1(config-if)#ipv6 address 1::1/128
R2(config-rtr)#int lo0
R2(config-if)#ipv6 address 2::2/128
R3(config-rtr)#int lo0
R3(config-if)#ipv6 address 3::3/128

```

Konfigurasi EIGRP pada ketiga router.

```

R1(config)#ipv6 router eigrp 13
R1(config-rtr)#router-id 1.1.1.1
R1(config-rtr)#no shut
*Mar 1 00:34:24.023: %DUAL-5-NBRCHANGE: IPv6-EIGRP(0) 13: Neighbor
FE80::C202:CFF:FED8:0 (FastEthernet0/0) is up: new adjacency
R2(config-rtr)#int lo0
R2(config-if)#ipv6 eigrp 13
R1(config-rtr)#int fa0/0
R1(config-if)#ipv6 eigrp 13

```

```

R2(config)#ipv6 router eigrp 13
R2(config-rtr)#router-id 2.2.2.2
R2(config-rtr)#no shut
*Mar 1 00:33:55.991: %DUAL-5-NBRCHANGE: IPv6-EIGRP(0) 13: Neighbor
FE80::C203:3FF:FEA8:1 (FastEthernet0/1) is up: new adjacency
*Mar 1 00:34:25.179: %DUAL-5-NBRCHANGE: IPv6-EIGRP(0) 13: Neighbor
FE80::C201:9FF:FED0:0 (FastEthernet0/0) is up: new adjacency
R2(config-rtr)#int lo0

```



```
R2(config-if)#ipv6 eigrp 13
R2(config-rtr)#int fa0/0
R2(config-if)#ipv6 eigrp 13
R2(config-rtr)#int fa0/1
R2(config-if)#ipv6 eigrp 13
```

```
R3(config)#ipv6 router eigrp 13
R3(config-rtr)#router-id 3.3.3.3
R3(config-rtr)#no shut
*Mar  1 00:33:56.287: %DUAL-5-NBRCHANGE: IPv6-EIGRP(0) 13: Neighbor
FE80::C202:CFF:FED8:1 (FastEthernet0/1) is up: new adjacency
R2(config-rtr)#int lo0
R2(config-if)#ipv6 eigrp 13
R3(config-rtr)#int fa0/1
R3(config-if)#ipv6 eigrp 13
```

### Cek tabel routing dan tes ping.

```
R1#sh ipv6 route
IPv6 Routing Table - 7 entries
Codes: C - Connected, L - Local, S - Static, R - RIP, B - BGP
        U - Per-user Static route, M - MIPv6
        I1 - ISIS L1, I2 - ISIS L2, IA - ISIS interarea, IS - ISIS summary
        O - OSPF intra, OI - OSPF inter, OE1 - OSPF ext 1, OE2 - OSPF ext 2
        ON1 - OSPF NSSA ext 1, ON2 - OSPF NSSA ext 2
        D - EIGRP, EX - EIGRP external
LC  1::1/128 [0/0]
    via ::, Loopback0
D   2::2/128 [90/409600]
    via FE80::C202:CFF:FED8:0, FastEthernet0/0
D   3::3/128 [90/435200]
    via FE80::C202:CFF:FED8:0, FastEthernet0/0
C   12::/126 [0/0]
    via ::, FastEthernet0/0
L   12::1/128 [0/0]
    via ::, FastEthernet0/0
D   23::/64 [90/307200]
    via FE80::C202:CFF:FED8:0, FastEthernet0/0
L   FF00::/8 [0/0]
    via ::, Null0
R1#ping 2::2

Type escape sequence to abort.
Sending 5, 100-byte ICMP Echos to 2::2, timeout is 2 seconds:
!!!!
Success rate is 100 percent (5/5), round-trip min/avg/max = 16/44/92 ms
R1#ping 3::3

Type escape sequence to abort.
Sending 5, 100-byte ICMP Echos to 3::3, timeout is 2 seconds:
!!!!
Success rate is 100 percent (5/5), round-trip min/avg/max = 32/57/92 ms
R1#
```

## IPv6 OSPFv3

Hapus dulu EIGRP sebelumnya.

```
R1(config)##no ipv6 router eigrp 13
R2(config)##no ipv6 router eigrp 13
R3(config)##no ipv6 router eigrp 13
```

Sekarang konfigurasi OSPFv3 nya.

```
R1(config)#ipv6 router ospf 1
*Mar 1 00:21:43.595: %OSPFv3-4-NORTRID: OSPFv3 process 2 could not pick a
router-id,
R1(config-rtr)#router-id 1.1.1.1
R1(config-rtr)#int lo0
R1(config-if)#ipv6 ospf 1 area 0
R1(config-if)#int fa0/0
R1(config-if)#ipv6 ospf 1 area 0
```

```
R2(config)#ipv6 router ospf 2
*Mar 1 00:21:43.595: %OSPFv3-4-NORTRID: OSPFv3 process 2 could not pick a
router-id,
please configure manually
R2(config-rtr)#router-id 2.2.2.2
R2(config-rtr)#int lo0
R2(config-if)#ipv6 ospf 2 area 0
R2(config-if)#int fa0/0
R2(config-if)#ipv6 ospf 2 area 0
*Mar 1 00:22:34.395: %OSPFv3-5-ADJCHG: Process 2, Nbr 1.1.1.1 on
FastEthernet0/0 from LOADING to FULL, Loading Done
R2(config-if)#int fa0/1
R2(config-if)#ipv6 ospf 2 area 0
```

```
R3(config)#ipv6 router ospf 3
*Mar 1 00:25:00.603: %OSPFv3-4-NORTRID: OSPFv3 process 3 could not pick a
router-id,
please configure manually
R3(config-rtr)#router-id 3.3.3.3
R3(config-rtr)#int fa0/1
R3(config-if)#ipv6 ospf 3 area 0
*Mar 1 00:25:23.427: %OSPFv3-5-ADJCHG: Process 3, Nbr 2.2.2.2 on
FastEthernet0/1 from LOADING to FULL, Loading Done
R3(config-if)#int lo0
R3(config-if)#ipv6 ospf 3 area 0
```

Cek neighbor.

```
R2#sh ipv6 ospf neighbor
```

Neighbor ID	Pri	State	Dead Time	Interface ID	Interface
3.3.3.3	1	FULL/BDR	00:00:35	5	
FastEthernet0/1					
1.1.1.1	1	FULL/DR	00:00:27	4	
FastEthernet0/0					

```
R2#
```

## Cek tabel routing dan tes ping.

```
R1#sh ipv6 route
IPv6 Routing Table - 7 entries
Codes: C - Connected, L - Local, S - Static, R - RIP, B - BGP
       U - Per-user Static route, M - MIPv6
       I1 - ISIS L1, I2 - ISIS L2, IA - ISIS interarea, IS - ISIS summary
       O - OSPF intra, OI - OSPF inter, OE1 - OSPF ext 1, OE2 - OSPF ext 2
       ON1 - OSPF NSSA ext 1, ON2 - OSPF NSSA ext 2
       D - EIGRP, EX - EIGRP external
LC  1::1/128 [0/0]
     via ::, Loopback0
O   2::2/128 [110/10]
     via FE80::C202:CFF:FED8:0, FastEthernet0/0
O   3::3/128 [110/20]
     via FE80::C202:CFF:FED8:0, FastEthernet0/0
C   12::/126 [0/0]
     via ::, FastEthernet0/0
L   12::1/128 [0/0]
     via ::, FastEthernet0/0
O   23::/64 [110/20]
     via FE80::C202:CFF:FED8:0, FastEthernet0/0
L   FF00::/8 [0/0]
     via ::, Null0
R1#ping 2::2

Type escape sequence to abort.
Sending 5, 100-byte ICMP Echos to 2::2, timeout is 2 seconds:
!!!!
Success rate is 100 percent (5/5), round-trip min/avg/max = 24/48/80 ms
R1#ping 3::3

Type escape sequence to abort.
Sending 5, 100-byte ICMP Echos to 3::3, timeout is 2 seconds:
!!!!
Success rate is 100 percent (5/5), round-trip min/avg/max = 36/70/144 ms
R1#
```

## IPv6 Tunneling

Tunneling adalah mengencapsulasi suatu packet data ke dalam packet data yang lain. Disini, packet IPv6 di encapsulasi ke dalam packet IPv4.

**Static Point-to-Point Tunnel**, digunakan untuk tunneling point-to-point dan support IGP pada IPv6. Static Point-to-Point Tunnel dibagi menjadi 2 yaitu:

- Manual Tunnel
- GRE (Generic Routing Encapsulation) Tunnel

Persamaan:

Sama-sama memforward multicast traffic.

Perbedaan:

- Untuk manual tunnel, seperti namanya, membutuhkan konfigurasi secara manual. GRE Tunnel sudah aktif secara default sehingga tidak perlu dikonfigurasi.
- GRE Tunnel mempunyai MTU yang lebih besar dibanding manual tunnel.
- Link-local GRE Tunnel dibuat secara otomatis dengan EUI-64 dan diambil dari MAC Address Interface yang paling rendah. Sedang link-local manual tunnel adalah FE80::/96 + 32 bit tunnel source IPv4.

**Dynamic Multipoint IPv6 Tunnel**, dinamakan dynamic karena tidak perlu dispesifikasikan end-point IPv4 secara manual, atau bisa dikatakan tidak perlu mengeset tunnel destination, digunakan untuk tunneling point to multipoint. Dynamic Multipoint IPv6 Tunnel ini tidak support IGP dan hanya support static routing atau BGP. Dynamic Multipoint IPv6 Tunnel ini dibagi menjadi 3:

- Automatic 6to4
- ISATAP (Intra-site Automatic Tunneling Addressing Protocol)

Automatic 6to4, menggunakan network 2002::/16. Network 2002::/16 memang disediakan khusus untuk tunneling dan bukan untuk global unicast.

ISATAP, hampir sama dengan 6to4, namun tidak menggunakan network 2002::/16 untuk tunneling namun menggunakan global unicast. ISATAP secara otomatis membuat tunnel ID menggunakan EUI-64.

## IPv6 IPv6IP Tunneling

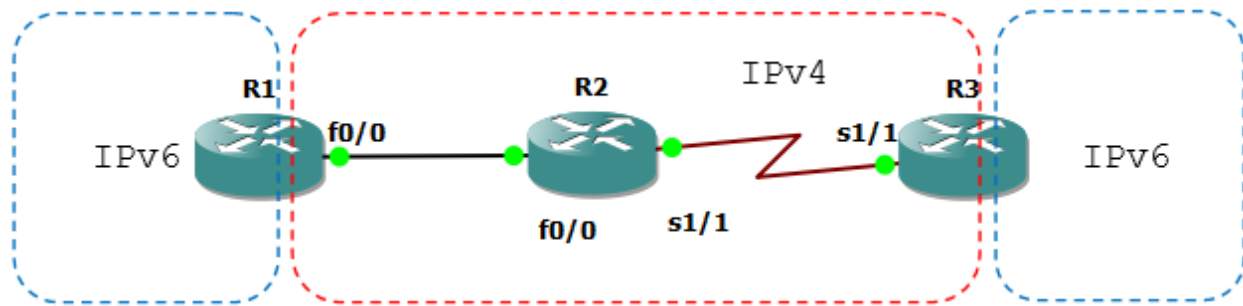

```
R1(config)#ipv6 unicast-routing
R1(config)#int lo0
R1(config-if)#ipv6 address 1::1/128
R1(config-if)#int fa0/0
R1(config-if)#ip address 12.12.12.1 255.255.255.0
R1(config-if)#no sh
```

```
R2(config-if)#int fa0/0
R2(config-if)#ip add 12.12.12.2 255.255.255.0
R2(config-if)#no sh
R2(config-if)#int s1/1
R2(config-if)#ip add 23.23.23.2 255.255.255.0
R2(config-if)#no sh
```

```
R3(config)#ipv6 unicast-routing
R3(config)#int lo0
R3(config-if)#ipv6 add 3::3/128
R3(config-if)#int se1/1
R3(config-if)#ip add 23.23.23.3 255.255.255.0
R3(config-if)#no sh
```

Sekarang konfigurasi routing IPv4 nya, boleh pake static, EIGRP ato OSPF.

```
R1(config-if)#router ospf 1
R1(config-router)#net 12.12.12.0 0.0.0.255 area 0
```

```
R2(config-if)#router ospf 2
R2(config-router)#net 12.12.12.0 0.0.0.255 area 0
R2(config-router)#net 23.23.23.0 0.0.0.255 area 0
```

```
R3(config-if)#router ospf 3
R3(config-router)#net 23.23.23.0 0.0.0.255 area 0
```

Cek ping dulu.

```
R1#ping 23.23.23.3
```

```
Type escape sequence to abort.
Sending 5, 100-byte ICMP Echos to 23.23.23.3, timeout is 2 seconds:
!!!!
Success rate is 100 percent (5/5), round-trip min/avg/max = 84/99/116 ms
R1#sh ip route
```

```

Gateway of last resort is not set

    23.0.0.0/24 is subnetted, 1 subnets
O       23.23.23.0 [110/74] via 12.12.12.2, 00:02:39, FastEthernet0/0
    12.0.0.0/24 is subnetted, 1 subnets
C       12.12.12.0 is directly connected, FastEthernet0/0
R1#

```

## Konfigurasi tunnel IPv6IP.

```

R1(config)#int tun13
*Mar  1 00:21:38.631: %LINEPROTO-5-UPDOWN: Line protocol on Interface
Tunnell13, changed state to down
R1(config-if)#ipv6 address 13::1/64
R1(config-if)#tunnel source 12.12.12.1
R1(config-if)#tunnel destination 23.23.23.3
*Mar  1 00:22:26.331: %LINEPROTO-5-UPDOWN: Line protocol on Interface
Tunnell13, changed state to up
R1(config-if)#tunnel mode ?
  aurp      AURP TunnelTalk AppleTalk encapsulation
  cayman    Cayman TunnelTalk AppleTalk encapsulation
  dvmrp     DVMRP multicast tunnel
  eon       EON compatible CLNS tunnel
  gre       generic route encapsulation protocol
  ipip      IP over IP encapsulation
  ipsec     IPsec tunnel encapsulation
  iptalk    Apple IPTalk encapsulation
  ipv6      Generic packet tunneling in IPv6
  ipv6ip    IPv6 over IP encapsulation
  mpls      MPLS encapsulations
  nos       IP over IP encapsulation (KA9Q/NOS compatible)
  rbscp     RBSCP in IP tunnel

R1(config-if)#tunnel mode ipv6ip

```

```

R3(config)#int tun31
R3(config-if)#ipv6 add 13::3/64
R3(config-if)#tunnel source 23.23.23.3
R3(config-if)#tunnel destination 12.12.12.1
R3(config-if)#tunnel mode ipv6ip

```

```

R1#sh ipv6 int br
FastEthernet0/0          [up/up]
FastEthernet0/1          [administratively down/down]
Serial1/0                [administratively down/down]
Serial1/1                [administratively down/down]
Serial1/2                [administratively down/down]
Serial1/3                [administratively down/down]
Loopback0                [up/up]
    FE80::C201:11FF:FE04:0
    1::1
Tunnell13                [up/up]
    FE80::C0C:C01

```

```

13::1
R1#sh ipv6 int tun13
Tunnel13 is up, line protocol is up
  IPv6 is enabled, link-local address is FE80::C0C:C01
  No Virtual link-local address(es):
  Global unicast address(es):
    13::1, subnet is 13::/64
  Joined group address(es):
    FF02::1
    FF02::2
    FF02::1:FF00:1
    FF02::1:FF0C:C01
  MTU is 1480 bytes
  ICMP error messages limited to one every 100 milliseconds
  ICMP redirects are enabled
  ICMP unreachable are sent
  ND DAD is enabled, number of DAD attempts: 1
  ND reachable time is 30000 milliseconds
  Hosts use stateless autoconfig for addresses.
R1#sh int tun13
Tunnel13 is up, line protocol is up
  Hardware is Tunnel
  MTU 1514 bytes, BW 9 Kbit, DLY 500000 usec,
    reliability 255/255, txload 1/255, rxload 1/255
  Encapsulation TUNNEL, loopback not set
  Keepalive not set
  Tunnel source 12.12.12.1, destination 23.23.23.3
  Tunnel protocol/transport IPv6/IP
  Tunnel TTL 255
  Fast tunneling enabled
  Tunnel transmit bandwidth 8000 (kbps)
  Tunnel receive bandwidth 8000 (kbps)
  Last input 00:02:22, output 00:07:11, output hang never
  Last clearing of "show interface" counters never
  Input queue: 0/75/0/0 (size/max/drops/flushes); Total output drops: 0
  Queueing strategy: fifo
  Output queue: 0/0 (size/max)
  5 minute input rate 0 bits/sec, 0 packets/sec
  5 minute output rate 0 bits/sec, 0 packets/sec
    9 packets input, 1008 bytes, 0 no buffer
    Received 0 broadcasts, 0 runts, 0 giants, 0 throttles
    0 input errors, 0 CRC, 0 frame, 0 overrun, 0 ignored, 0 abort
    23 packets output, 2152 bytes, 0 underruns
    0 output errors, 0 collisions, 0 interface resets
    0 output buffer failures, 0 output buffers swapped out
R1#

```

**Sekarang tes ping.**

```
R1#ping 3::3
```

```

Type escape sequence to abort.
Sending 5, 100-byte ICMP Echos to 3::3, timeout is 2 seconds:
!!!!
Success rate is 100 percent (5/5), round-trip min/avg/max = 92/157/240 ms
R1#sh ipv6 ro
R1#sh ipv6 route
IPv6 Routing Table - 5 entries
Codes: C - Connected, L - Local, S - Static, R - RIP, B - BGP
       U - Per-user Static route, M - MIPv6
       I1 - ISIS L1, I2 - ISIS L2, IA - ISIS interarea, IS - ISIS summary
       O - OSPF intra, OI - OSPF inter, OE1 - OSPF ext 1, OE2 - OSPF ext 2
       ON1 - OSPF NSSA ext 1, ON2 - OSPF NSSA ext 2
       D - EIGRP, EX - EIGRP external
LC 1::1/128 [0/0]
   via ::, Loopback0
S 3::3/128 [1/0]
   via 13::3
C 13::/64 [0/0]
   via ::, Tunnel13
L 13::1/128 [0/0]
   via ::, Tunnel13
L FF00::/8 [0/0]
   via ::, Null0
R1#

```

## IPv6 GRE IP Tunneling

Dari lab sebelumnya tinggal merubah tunnel mode atau cukup menghapus tunnel mode sebelumnya karena GRE IP Tunneling secara default aktif.

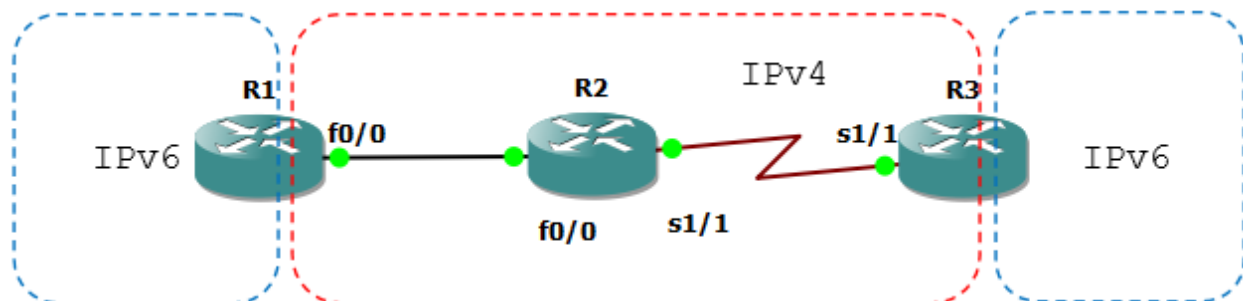

Lakukan konfigurasi berikut.

```

R1(config)#int tunnel 13
R1(config-if)#tunnel mode ipv6i
R1(config-if)#no tunnel mode ipv6ip

R3(config)#int tunnel 31
R3(config-if)#tunnel mode gre ip

```

Cek interfacenya.

```

R3#show int tunnel31
Tunnel31 is up, line protocol is up

```



```

Hardware is Tunnel
MTU 1514 bytes, BW 9 Kbit, DLY 500000 usec,
  reliability 255/255, txload 1/255, rxload 1/255
Encapsulation TUNNEL, loopback not set
Keepalive not set
Tunnel source 23.23.23.3, destination 12.12.12.1
Tunnel protocol/transport GRE/IP
  Key disabled, sequencing disabled
  Checksumming of packets disabled
Tunnel TTL 255
Fast tunneling enabled
Tunnel transmit bandwidth 8000 (kbps)
Tunnel receive bandwidth 8000 (kbps)
Last input 00:03:54, output 00:03:54, output hang never
Last clearing of "show interface" counters never
Input queue: 0/75/0/0 (size/max/drops/flushes); Total output drops: 0
Queueing strategy: fifo
Output queue: 0/0 (size/max)
5 minute input rate 0 bits/sec, 0 packets/sec
5 minute output rate 0 bits/sec, 0 packets/sec
  29 packets input, 3296 bytes, 0 no buffer
  Received 0 broadcasts, 0 runts, 0 giants, 0 throttles
  0 input errors, 0 CRC, 0 frame, 0 overrun, 0 ignored, 0 abort
  38 packets output, 3988 bytes, 0 underruns
  0 output errors, 0 collisions, 0 interface resets
  0 output buffer failures, 0 output buffers swapped out
R3#

Tes ping.
R3#ping 1::1

Type escape sequence to abort.
Sending 5, 100-byte ICMP Echos to 1::1, timeout is 2 seconds:
!!!!
Success rate is 100 percent (5/5), round-trip min/avg/max = 76/116/152 ms
R3#

```

## IPv6 Tunnel 6to4

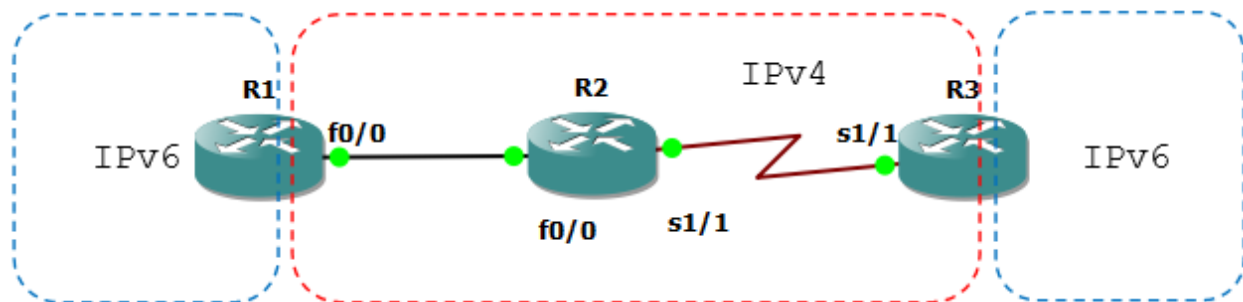

Masih menggunakan topologi sebelumnya. Hapus dulu interface tunnel dan ipv6 routenya.

```
R1(config)#no int tun13
R1(config)#do sh run | s i ipv6 route
ipv6 route 3::3/128 13::3
R1(config)#no ipv6 route 3::3/128 13::3
```

```
R3(config)#no int tun31
R3(config)#do sh run | s i ipv6 route
ipv6 route 1::1/128 13::1
R3(config)#no ipv6 route 1::1/128 13::1
```

## Konfigurasi 6to4 tunnel.

```
R1(config)#int tunnel 103
R1(config-if)#ipv6 address 2002:0C0C:0C01::1/64
R1(config-if)#tunnel source 12.12.12.1
R1(config-if)#tunnel mode ipv6ip ?
  6to4          IPv6 automatic tunnelling using 6to4
  auto-tunnel   IPv6 automatic tunnelling using IPv4 compatible addresses
  isatap        IPv6 automatic tunnelling using ISATAP
  <cr>
```

```
R1(config-if)#tunnel mode ipv6ip 6to4
```

```
R3(config)#int tunnel 301
  Tunnel301, changed state to down
R3(config-if)#tunnel source 23.23.23.3
R3(config-if)#ipv6 address 2002:1717:1703::3/64
R3(config-if)#tunnel mode ipv6ip 6to4
```

## Pengecekan.

```
R3(config-if)#do ping 2002:0C0C:0C01::1
```

```
Type escape sequence to abort.
Sending 5, 100-byte ICMP Echos to 2002:C0C:C01::1, timeout is 2 seconds:
!!!!
Success rate is 100 percent (5/5), round-trip min/avg/max = 120/147/196 ms
R3(config-if)#
```

```
R1(config-if)#do ping 2002:1717:1703::3
```

```
Type escape sequence to abort.
Sending 5, 100-byte ICMP Echos to 2002:1717:1703::3, timeout is 2 seconds:
!!!!
Success rate is 100 percent (5/5), round-trip min/avg/max = 124/139/168 ms
R1(config-if)#
```

```
R1#sh int tun 103
Tunnel103 is up, line protocol is up
  Hardware is Tunnel
  MTU 1514 bytes, BW 9 Kbit, DLY 500000 usec,
    reliability 255/255, txload 1/255, rxload 1/255
  Encapsulation TUNNEL, loopback not set
  Keepalive not set
  Tunnel source 12.12.12.1, destination UNKNOWN
  Tunnel protocol/transport IPv6 6to4
  Tunnel TTL 255
  Fast tunneling enabled
```

```

Tunnel transmit bandwidth 8000 (kbps)
Tunnel receive bandwidth 8000 (kbps)
Last input never, output 00:01:41, output hang never
Last clearing of "show interface" counters never
Input queue: 0/75/0/0 (size/max/drops/flushes); Total output drops: 0
Queueing strategy: fifo
Output queue: 0/0 (size/max)
5 minute input rate 0 bits/sec, 0 packets/sec
5 minute output rate 0 bits/sec, 0 packets/sec
  0 packets input, 0 bytes, 0 no buffer
  Received 0 broadcasts, 0 runts, 0 giants, 0 throttles
  0 input errors, 0 CRC, 0 frame, 0 overrun, 0 ignored, 0 abort
  6 packets output, 576 bytes, 0 underruns
  0 output errors, 0 collisions, 0 interface resets
  0 output buffer failures, 0 output buffers swapped out

```

Hitung IP tunnelnya sebagai berikut:

12.12.12.1 -> 01100.01100.01100.0001 -> **0C0C:0C01** -> 2002:**0C0C:0C01**::1

23.23.23.3 -> 10111.10111.10111.0011 -> **1717:1703** -> 2002:**1717:1703**::3

IP tunnel 6to4 menggunakan network 2002:/64. Untuk lebih mudahnya, perhitungan diatas dapat menggunakan calculator pada os windows dengan mode programmer.

## IPv6 Tunnel ISATAP

Masih memakai topologi sebelumnya. Hapus dulu interface tunnel dan ipv6 routenya.

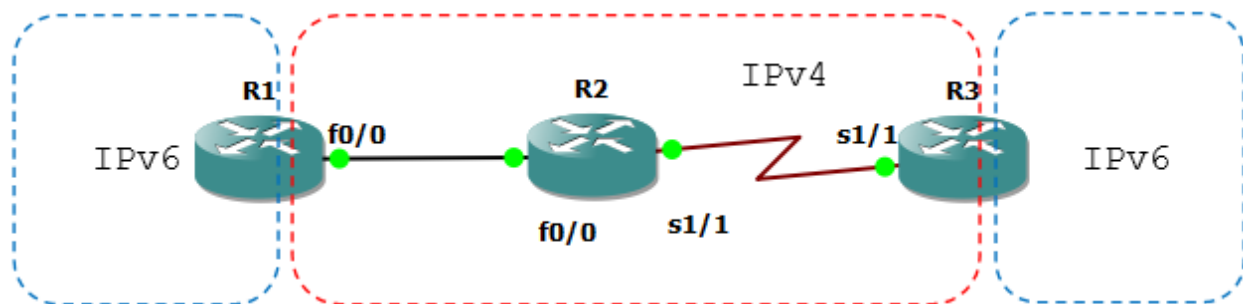

```

R1(config)#no int tun103
R3(config)#no int tun301

```

### Konfigurasi tunnel ISATAP.

```

R1(config)#int tun 1003
R1(config-if)#ipv6 address 13::/64 eui-64
*Mar 1 00:52:50.127: %LINEPROTO-5-UPDOWN: Line protocol on Interface
Tunnel1003, changed state to down
R1(config-if)#tunnel source 12.12.12.1
R1(config-if)#tunnel mode ipv6ip isatap

```

```
R3(config)#int tun 3001
*Mar  1 00:54:17.359: %LINEPROTO-5-UPDOWN: Line protocol on Interface
Tunnel3001, changed state to down
R3(config-if)#tunnel source 23.23.23.3
R3(config-if)#ipv6 add 13::/64 eui-64
R3(config-if)#tunnel mode ipv6ip isatap
```

## Tes ping.

```
R1(config-if)#do sh ipv6 int br
FastEthernet0/0          [up/up]
FastEthernet0/1          [administratively down/down]
Serial1/0                 [administratively down/down]
Serial1/1                 [administratively down/down]
Serial1/2                 [administratively down/down]
Serial1/3                 [administratively down/down]
Loopback0                 [up/up]
    FE80::C201:11FF:FE04:0
    1::1
Tunnel1003                [up/up]
    FE80::5EFE:C0C:C01
    13::5EFE:C0C:C01
R1(config-if)#

R3(config-if)#do ping

Type escape sequence to abort.
Sending 5, 100-byte ICMP Echos to 13::5EFE:C0C:C01, timeout is 2 seconds:
!!!!
Success rate is 100 percent (5/5), round-trip min/avg/max = 92/124/152 ms
R3(config-if)#
```

## Masukkan routing static.

```
R1(config)#ipv6 route 3::3/128 13::5EFE:1717:1703
R3(config)#ipv6 route 1::1/128 13::5EFE:C0C:C01
```

## Pengecekan.

```
R1(config)#do ping 3::3

Type escape sequence to abort.
Sending 5, 100-byte ICMP Echos to 3::3, timeout is 2 seconds:
!!!!
Success rate is 100 percent (5/5), round-trip min/avg/max = 96/117/136 ms
R1(config)#

R3(config)#do ping 1::1

Type escape sequence to abort.
Sending 5, 100-byte ICMP Echos to 1::1, timeout is 2 seconds:
!!!!
Success rate is 100 percent (5/5), round-trip min/avg/max = 92/132/168 ms
R3(config)#

R1(config)#do sh int tun1003
Tunnel1003 is up, line protocol is up
  Hardware is Tunnel
  MTU 1514 bytes, BW 9 Kbit, DLY 500000 usec,
```

```

reliability 255/255, txload 1/255, rxload 1/255
Encapsulation TUNNEL, loopback not set
Keepalive not set
Tunnel source 12.12.12.1, destination UNKNOWN
Tunnel protocol/transport IPv6 ISATAP
Tunnel TTL 255
Fast tunneling enabled
Tunnel transmit bandwidth 8000 (kbps)
Tunnel receive bandwidth 8000 (kbps)
Last input 00:00:53, output 00:00:53, output hang never
Last clearing of "show interface" counters never
Input queue: 0/75/0/0 (size/max/drops/flushes); Total output drops: 0
Queueing strategy: fifo
Output queue: 0/0 (size/max)
5 minute input rate 0 bits/sec, 0 packets/sec
5 minute output rate 0 bits/sec, 0 packets/sec
 15 packets input, 2100 bytes, 0 no buffer
 Received 0 broadcasts, 0 runts, 0 giants, 0 throttles
  0 input errors, 0 CRC, 0 frame, 0 overrun, 0 ignored, 0 abort
 19 packets output, 2184 bytes, 0 underruns
  0 output errors, 0 collisions, 0 interface resets
  0 output buffer failures, 0 output buffers swapped out

```

## IPv6 Tunnel Auto-Tunnel

Masih memakai topologi sebelumnya. Hapus dulu interface tunnel dan ipv6 routenya.

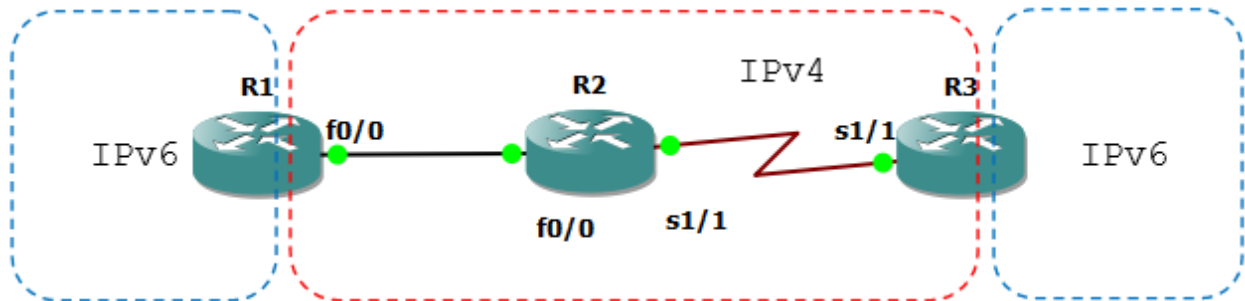

```

R1(config)#no int tun1003
R3(config)#no int tun3001

```

## Konfigurasi tunnel autotunnel.

```

R1(config)#int tun10003
*Mar 1 00:03:09.163: %LINEPROTO-5-UPDOWN: Line protocol on Interface
Tunnel10003, changed state to down
R1(config-if)#tunnel source 12.12.12.1
R1(config-if)#tunnel mode ipv6ip auto-tunnel

R3(config)#int tun30001

```

```
*Mar 1 00:04:15.243: %LINEPROTO-5-UPDOWN: Line protocol on Interface
Tunnel30001, changed state to down
R3(config-if)#tunnel source 23.23.23.3
R3(config-if)#tunnel mode ipv6ip au
R3(config-if)#tunnel mode ipv6ip auto-tunnel
```

## Ping tunnelnya.

```
R3(config-if)#do ping ::12.12.12.1

Type escape sequence to abort.
Sending 5, 100-byte ICMP Echos to ::12.12.12.1, timeout is 2 seconds:
!!!!
Success rate is 100 percent (5/5), round-trip min/avg/max = 104/136/184 ms
R3(config-if)#do sh int tun30001
Tunnel30001 is up, line protocol is up
  Hardware is Tunnel
  MTU 1514 bytes, BW 9 Kbit, DLY 500000 usec,
    reliability 255/255, txload 1/255, rxload 1/255
  Encapsulation TUNNEL, loopback not set
  Keepalive not set
  Tunnel source 23.23.23.3, destination UNKNOWN
  Tunnel protocol/transport IPv6 auto-tunnel
  Tunnel TTL 255
  Fast tunneling enabled
  Tunnel transmit bandwidth 8000 (kbps)
  Tunnel receive bandwidth 8000 (kbps)
  Last input 00:00:47, output 00:00:47, output hang never
  Last clearing of "show interface" counters never
  Input queue: 0/75/0/0 (size/max/drops/flushes); Total output drops: 0
  Queueing strategy: fifo
  Output queue: 0/0 (size/max)
  5 minute input rate 0 bits/sec, 0 packets/sec
  5 minute output rate 0 bits/sec, 0 packets/sec
    5 packets input, 700 bytes, 0 no buffer
    Received 0 broadcasts, 0 runts, 0 giants, 0 throttles
    0 input errors, 0 CRC, 0 frame, 0 overrun, 0 ignored, 0 abort
    9 packets output, 984 bytes, 0 underruns
    0 output errors, 0 collisions, 0 interface resets
    0 output buffer failures, 0 output buffers swapped out
R3(config-if)#
```

## Konfigurasi static routing.

```
R1(config)#ipv6 route 3::3/128 ::23.23.23.3
R3(config)#ipv6 route 1::1/128 ::12.12.12.1
```

## Pengecekan.

```
R1(config)#do ping 3::3

Type escape sequence to abort.
Sending 5, 100-byte ICMP Echos to 3::3, timeout is 2 seconds:
!!!!
Success rate is 100 percent (5/5), round-trip min/avg/max = 120/136/168 ms
R1(config)#

R3(config)#do ping 1::1
```

```
Type escape sequence to abort.  
Sending 5, 100-byte ICMP Echos to 1::1, timeout is 2 seconds:  
!!!!  
Success rate is 100 percent (5/5), round-trip min/avg/max = 84/131/156 ms  
R3(config)#
```

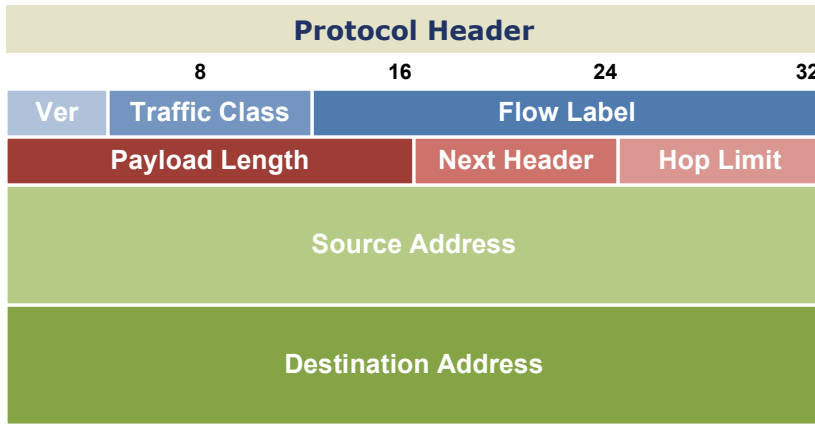

- Version** (4 bits) · Always set to 6
- Traffic Class** (8 bits) · A DSCP value for QoS
- Flow Label** (20 bits) · Identifies unique flows (optional)
- Payload Length** (16 bits) · Length of the payload in bytes
- Next Header** (8 bits) · Header or protocol which follows
- Hop Limit** (8 bits) · Similar to IPv4's time to live field
- Source Address** (128 bits) · Source IP address
- Destination Address** (128 bits) · Destination IP address

- ### Address Types
- Unicast** · One-to-one communication
  - Multicast** · One-to-many communication
  - Anycast** · An address configured in multiple locations

- ### Multicast Scopes
- |                          |                     |
|--------------------------|---------------------|
| <b>1</b> Interface-local | <b>5</b> Site-local |
| <b>2</b> Link-local      | <b>8</b> Org-local  |
| <b>4</b> Admin-local     | <b>E</b> Global     |

- ### Special-Use Ranges
- |                      |                     |
|----------------------|---------------------|
| <b>::/0</b>          | Default route       |
| <b>::/128</b>        | Unspecified         |
| <b>::1/128</b>       | Loopback            |
| <b>::/96</b>         | IPv4-compatible*    |
| <b>::FFFF:0:0/96</b> | IPv4-mapped         |
| <b>2001::/32</b>     | Teredo              |
| <b>2001:DB8::/32</b> | Documentation       |
| <b>2002::/16</b>     | 6to4                |
| <b>FC00::/7</b>      | Unique local        |
| <b>FE80::/10</b>     | Link-local unicast  |
| <b>FEC0::/10</b>     | Site-local unicast* |
| <b>FF00::/8</b>      | Multicast           |
- \* Deprecated

- ### Address Notation
- Eliminate leading zeros from all two-byte sets
  - Replace up to one string of consecutive zeros with a double-colon (::)

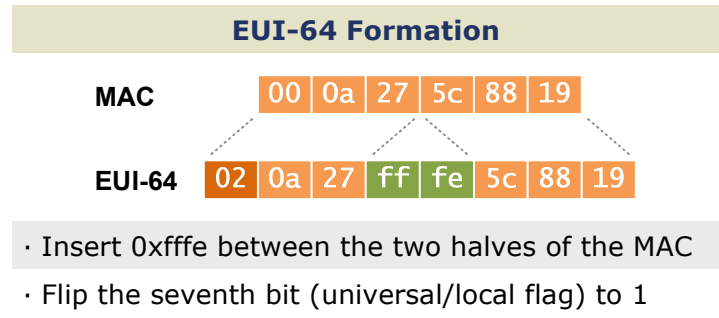
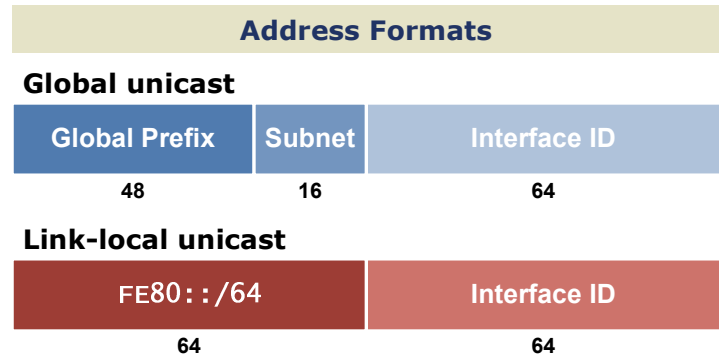

- ### Extension Headers
- Hop-by-hop Options (0)**  
Carries additional information which must be examined by every router in the path
  - Routing (43)**  
Provides source routing functionality
  - Fragment (44)**  
Included when a packet has been fragmented by its source
  - Encapsulating Security Payload (50)**  
Provides payload encryption (IPsec)
  - Authentication Header (51)**  
Provides packet authentication (IPsec)
  - Destination Options (60)**  
Carries additional information which pertains only to the recipient

- ### Transition Mechanisms
- Dual Stack**  
Transporting IPv4 and IPv6 across an infrastructure simultaneously
  - Tunneling**  
IPv6 traffic is encapsulated into IPv4 using IPv6-in-IP, UDP (Teredo), or Intra-Site Automatic Tunnel Addressing Protocol (ISATAP)
  - Translation**  
Stateless IP/ICMP Translation (SIIT) translates IP header fields, NAT Protocol Translation (NAT-PT) maps between IPv6 and IPv4 addresses



# EIGRP

- EIGRP Basic Configuration
- EIGRP Filtering - Distribute List
  - EIGRP Filtering - Prefix List
  - EIGRP Filtering - Access List
- EIGRP Filtering - Administrative Distance
  - EIGRP Authentication
  - EIGRP Summarization
  - EIGRP Unicast Update
- EIGRP Default Route – Summary Address
  - EIGRP Redistribution - RIP
  - EIGRP Redistribution - OSPF
  - EIGRP Path Selection - Delay
  - EIGRP Path Selection - Bandwidth
  - EIGRP Equal Load Balancing
  - EIGRP Unequal Load Balancing
- EIGRP Stub – Connected + Summary
  - EIGRP Stub – Connected
  - EIGRP Stub – Summary
  - EIGRP Stub – Static
  - EIGRP Stub – Redistributed
  - EIGRP Stub – Receive Only

## (EIGRP)

# Enhanced Interior Gateway Protocol

EIGRP merupakan distance vector protocol dan cisco proprietary. Menggunakan algoritma DUAL (Diffusing Update Algorithm).

- Advanced distance vector/hybrid routing protocol
- Multicast or unicast for exchange information use port 88
- Administrative distance 90
- Classless routing protocol support VLSM/CIDR.
- Support IPv6
- Rich metric (bandwidth, delay, load and reliability)
- Very fast convergence
- Equal and Unequal Load balancing
- 100% loop-free

Dinamakan advanced distance vector atau hybrid routing protocol karena EIGRP tidak seperti RIP yang:

- No neighbor discovery
- Periodic updates
- Vulnerable to loops
- Simple metric (hop count)

Cisco menambahkan fitur-fitur dari link state pada EIGRP sehingga dapat mengatasi masalah-masalah RIP. Pada router yang menjalankan EIGRP akan mempunyai 3 database(tabel):

EIGRP neighbor table

- List semua directly connected neighbor
- Next-hop router
- Interface

EIGRP topology table

- List semua route yang dipelajari dari semua EIGRP neighbor
- Destination
- Metric

## Routing table

- Best route dari EIGRP topology table

## Successor and Feasible Successor

- Successor = best path to destination
- Feasible Successor = backup link to destination

## EIGRP Packets

### Hello Packet

- Untuk discover dan recovery neighbor serta membentuk adjacency.
- Jika penerima membalas dengan hello packet maka terjadi adjacency. Jika penerima tidak mengirim hello packet dalam X waktu (hold time), maka adjacency akan didrop.
- Setelah adjacency terbentuk, akan melakukan exchange routing information yang akan disimpan di topology table. Best path dari topology table akan disave di routing table.
- Reliable

### Update Packet

- Berisi informasi routing
- Dapat dikirim secara unicast atau multicast
- Reliable

### Query Packet

- Dikirim jika suatu router EIGRP kehilangan informasi tentang suatu network, maka query akan dikirim ke neighbor untuk mendapat informasi tentang neighbor yang hilang tadi.

### Reply Packet

- Response dari query packet

### ACK Packet

- Dikirim sebagai pemberitahuan bahwa telah menerima update packet.
- Dikirim secara unicast.

## No Auto-Summary

Digunakan untuk menyertakan subnetmask dalam advertise network.

## EIGRP Basic Configuration



Ketikkan konfigurasi interface berikut. Pastikan dapat ping antar interface yang directly connect.

```
R1
interface Loopback0
ip address 1.1.1.1 255.255.255.255
!
interface Serial0/0
ip address 12.12.12.1 255.255.255.0
!

R2
interface Loopback0
ip address 2.2.2.2 255.255.255.255
!
interface Serial0/0
ip address 12.12.12.2 255.255.255.0
!
interface Serial0/1
ip address 23.23.23.2 255.255.255.0
!

R3
interface Loopback0
ip address 3.3.3.3 255.255.255.255
!
interface Serial0/0
ip address 23.23.23.3 255.255.255.0
!
```

Konfigurasi EIGRP. Advertise network ke dalam routing EIGRP. Autonomous Number (AS Number) harus sama pada setiap router.

```
R1
router eigrp 10
network 1.1.1.1 0.0.0.0
network 12.12.12.1 0.0.0.0
no auto-summary

R2
router eigrp 10
network 2.2.2.2 0.0.0.0
network 12.12.12.2 0.0.0.0
network 23.23.23.2 0.0.0.0
no auto-summary

R3
router eigrp 10
```

```
network 3.3.3.3 0.0.0.0
network 23.23.23.3 0.0.0.0
no auto-summary
```

## Cek routing tabel dan tes ping.

```
R1#show ip route
```

```
Gateway of last resort is not set
```

```
    1.0.0.0/32 is subnetted, 1 subnets
C       1.1.1.1 is directly connected, Loopback0
    2.0.0.0/32 is subnetted, 1 subnets
D       2.2.2.2 [90/2297856] via 12.12.12.2, 00:06:56, Serial0/0
    3.0.0.0/32 is subnetted, 1 subnets
D       3.3.3.3 [90/2809856] via 12.12.12.2, 00:06:56, Serial0/0
    23.0.0.0/24 is subnetted, 1 subnets
D       23.23.23.0 [90/2681856] via 12.12.12.2, 00:06:56, Serial0/0
    12.0.0.0/24 is subnetted, 1 subnets
C       12.12.12.0 is directly connected, Serial0/0
R1#ping 2.2.2.2
```

```
Type escape sequence to abort.
```

```
Sending 5, 100-byte ICMP Echos to 2.2.2.2, timeout is 2 seconds:
```

```
!!!!!
```

```
Success rate is 100 percent (5/5), round-trip min/avg/max = 60/75/128 ms
```

```
R1#ping 3.3.3.3
```

```
Type escape sequence to abort.
```

```
Sending 5, 100-byte ICMP Echos to 3.3.3.3, timeout is 2 seconds:
```

```
!!!!!
```

```
Success rate is 100 percent (5/5), round-trip min/avg/max = 60/88/116 ms
```

## EIGRP Filtering - Distribute List

Digunakan untuk memfilter network berdasarkan route network yang masuk dan keluar interface. Pada topologi dibawah, tujuannya agar ip loopback 2.2.2.2 tidak ada dalam routing tabel R1.

Cara pertama: filter network menggunakan access list pada R1 dengan distribute IN.

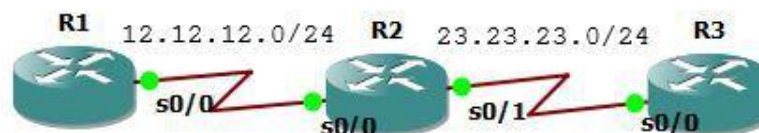

Masih menggunakan lab sebelumnya.

```
access-list 10 deny 2.2.2.2
access-list 10 permit any
router eigrp 10
```

```
distribute-list 10 in Serial0/0
```

### Cek ip route.

```
R1#sh ip route
```

```
Gateway of last resort is not set
```

```
    1.0.0.0/32 is subnetted, 1 subnets
C       1.1.1.1 is directly connected, Loopback0
    3.0.0.0/32 is subnetted, 1 subnets
D       3.3.3.3 [90/2809856] via 12.12.12.2, 00:00:39, Serial0/0
    23.0.0.0/24 is subnetted, 1 subnets
D       23.23.23.0 [90/2681856] via 12.12.12.2, 00:00:39, Serial0/0
    12.0.0.0/24 is subnetted, 1 subnets
C       12.12.12.0 is directly connected, Serial0/0
R1#
```

Cara kedua: filter network menggunakan access list pada R2 dengan distribute OUT. Pastikan ip loopback 2.2.2.2 ada lagi dalam tabel routing R1 lalu pada R2 ketik perintah dibawah.

```
router eigrp 10
access-list 10 deny 2.2.2.2
access-list 10 permit any
distribute-list 10 out Serial0/0
```

Cek routing tabel pastikan ip loopback 2.2.2.2 tidak ada.

## EIGRP Filtering - Prefix List

Memfilter network berdasarkan prefix. Ketika dimasukkan prefix list IN pada R2, maka network R3 yang dideny oleh R2 tidak akan diadvertise ke R1.

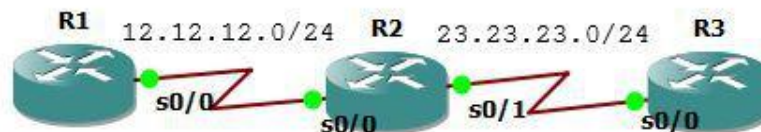

Masih menggunakan lab sebelumnya. Tujuannya agar network pada R3 dengan prefix 24 sampai 28 diblok, selain itu ditampilkan.

```
R1
interface Loopback0
 ip address 1.1.1.1 255.255.255.255
!
interface Serial0/0
 ip address 12.12.12.1 255.255.255.0
!
router eigrp 10
 network 0.0.0.0
 no auto-summary
```

```

!
R2
interface Loopback0
 ip address 2.2.2.2 255.255.255.255
!
interface Serial0/0
 ip address 12.12.12.2 255.255.255.0
!
interface Serial0/1
 ip address 23.23.23.2 255.255.255.0
!
router eigrp 10
 network 0.0.0.0
 no auto-summary
!
R3
interface Loopback0
 ip address 3.3.3.3 255.255.255.255
!
interface Serial0/0
 ip address 23.23.23.3 255.255.255.0
!
router eigrp 10
 network 0.0.0.0
 no auto-summary
!

```

**Pada R1, buat ip loopback yang bervariasi untuk difilter.**

```

interface Loopback1
 ip address 3.3.3.17 255.255.255.240
!
interface Loopback2
 ip address 3.3.3.33 255.255.255.248
!
interface Loopback3
 ip address 3.3.3.150 255.255.255.252
!
interface Loopback4
 ip address 3.3.3.200 255.255.255.240
!
interface Loopback5
 ip address 3.3.3.100 255.255.255.224
!

```

**Cek tabel routing R1.**

```

R1#sh ip route

Gateway of last resort is not set

    1.0.0.0/32 is subnetted, 1 subnets
C       1.1.1.1 is directly connected, Loopback0
    2.0.0.0/32 is subnetted, 1 subnets
D       2.2.2.2 [90/2297856] via 12.12.12.2, 00:04:45, Serial0/0
    3.0.0.0/8 is variably subnetted, 6 subnets, 5 masks

```

```

D      3.3.3.3/32 [90/2809856] via 12.12.12.2, 00:04:44, Serial0/0
D      3.3.3.16/28 [90/2809856] via 12.12.12.2, 00:00:02, Serial0/0
D      3.3.3.32/29 [90/2809856] via 12.12.12.2, 00:04:44, Serial0/0
D      3.3.3.96/27 [90/2809856] via 12.12.12.2, 00:00:05, Serial0/0
D      3.3.3.148/30 [90/2809856] via 12.12.12.2, 00:04:46, Serial0/0
D      3.3.3.192/28 [90/2809856] via 12.12.12.2, 00:00:05, Serial0/0
23.0.0.0/24 is subnetted, 1 subnets
D      23.23.23.0 [90/2681856] via 12.12.12.2, 00:04:47, Serial0/0
12.0.0.0/24 is subnetted, 1 subnets
C      12.12.12.0 is directly connected, Serial0/0
R1#

```

**Konfigurasi prefix list filtering pada R2 dan cek tabel routing. Route dengan prefix antara 24 sampai 28 sudah tidak ada.**

```

R2(config-router)#ip prefix-list EIGRP_IN seq 5 deny 3.3.3.0/24 le 28
R2(config)#ip prefix-list EIGRP_IN seq 10 permit 0.0.0.0/0 le 32
R2(config)#router eigrp 10
R2(config-router)#distribute-list prefix EIGRP_IN in
R2(config-router)#
*Mar 1 00:07:32.647: %DUAL-5-NBRCHANGE: IP-EIGRP(0) 10: Neighbor 12.12.12.1
(Serial0/0) is resync: route configuration changed
*Mar 1 00:07:32.647: %DUAL-5-NBRCHANGE: IP-EIGRP(0) 10: Neighbor 23.23.23.3
(Serial0/1) is resync: route configuration changed

```

```
R2#sh ip route
```

```
Gateway of last resort is not set
```

```

      1.0.0.0/32 is subnetted, 1 subnets
D      1.1.1.1 [90/2297856] via 12.12.12.1, 00:10:55, Serial0/0
      2.0.0.0/32 is subnetted, 1 subnets
C      2.2.2.2 is directly connected, Loopback0
      3.0.0.0/8 is variably subnetted, 3 subnets, 3 masks
D      3.3.3.3/32 [90/2297856] via 23.23.23.3, 00:02:51, Serial0/1
D      3.3.3.32/29 [90/2297856] via 23.23.23.3, 00:02:51, Serial0/1
D      3.3.3.148/30 [90/2297856] via 23.23.23.3, 00:02:51, Serial0/1
23.0.0.0/24 is subnetted, 1 subnets
C      23.23.23.0 is directly connected, Serial0/1
12.0.0.0/24 is subnetted, 1 subnets
C      12.12.12.0 is directly connected, Serial0/0
R2#

```

**Begitu juga pada R1.**

```
R1#sh ip route
```

```
Gateway of last resort is not set
```

```

      1.0.0.0/32 is subnetted, 1 subnets
C      1.1.1.1 is directly connected, Loopback0
      2.0.0.0/32 is subnetted, 1 subnets
D      2.2.2.2 [90/2297856] via 12.12.12.2, 00:11:45, Serial0/0
      3.0.0.0/8 is variably subnetted, 3 subnets, 3 masks
D      3.3.3.3/32 [90/2809856] via 12.12.12.2, 00:03:22, Serial0/0
D      3.3.3.32/29 [90/2809856] via 12.12.12.2, 00:03:22, Serial0/0
D      3.3.3.148/30 [90/2809856] via 12.12.12.2, 00:03:22, Serial0/0
23.0.0.0/24 is subnetted, 1 subnets

```



```
D      23.23.23.0 [90/2681856] via 12.12.12.2, 00:11:47, Serial0/0
      12.0.0.0/24 is subnetted, 1 subnets
C      12.12.12.0 is directly connected, Serial0/0
R1#
```

Masih menggunakan lab sebelumnya. Tujuannya agar network pada R3 dengan prefix 24 sampai 28 diblok, selain itu ditampilkan.

Jika sebelumnya memakai prefix IN, sekarang menggunakan OUT. Tujuannya agar network pada R3 dengan prefix 28 sampai 30 diblok, selain itu ditampilkan. Hapus konfigurasi prefix list IN sebelumnya.

```
R2(config)#router eigrp 10
R2(config-router)#no distribute-list prefix EIGRP_IN in
```

Pastikan semua network muncul pada tabel routing.

```
R1#sh ip route

Gateway of last resort is not set

      1.0.0.0/32 is subnetted, 1 subnets
C      1.1.1.1 is directly connected, Loopback0
      2.0.0.0/32 is subnetted, 1 subnets
D      2.2.2.2 [90/2297856] via 12.12.12.2, 00:04:45, Serial0/0
      3.0.0.0/8 is variably subnetted, 6 subnets, 5 masks
D      3.3.3.3/32 [90/2809856] via 12.12.12.2, 00:04:44, Serial0/0
D      3.3.3.16/28 [90/2809856] via 12.12.12.2, 00:00:02, Serial0/0
D      3.3.3.32/29 [90/2809856] via 12.12.12.2, 00:04:44, Serial0/0
D      3.3.3.96/27 [90/2809856] via 12.12.12.2, 00:00:05, Serial0/0
D      3.3.3.148/30 [90/2809856] via 12.12.12.2, 00:04:46, Serial0/0
D      3.3.3.192/28 [90/2809856] via 12.12.12.2, 00:00:05, Serial0/0
      23.0.0.0/24 is subnetted, 1 subnets
D      23.23.23.0 [90/2681856] via 12.12.12.2, 00:04:47, Serial0/0
      12.0.0.0/24 is subnetted, 1 subnets
C      12.12.12.0 is directly connected, Serial0/0
R1#
```

Konfigurasi prefix list filtering OUT pada R2.

```
R2(config-router)# ip prefix-list EIGRP_OUT seq 5 deny 3.3.3.0/24 ge 28 le
30
R2(config)# ip prefix-list EIGRP_OUT seq 10 permit 0.0.0.0/0 ge 24
R2(config)#router eigrp 10
R2(config-router)#distribute-list prefix EIGRP_OUT out
```

Cek tabel routing pada R1 dan R2.

```
R2#sh ip route

Gateway of last resort is not set

      1.0.0.0/32 is subnetted, 1 subnets
D      1.1.1.1 [90/2297856] via 12.12.12.1, 00:10:55, Serial0/0
      2.0.0.0/32 is subnetted, 1 subnets
C      2.2.2.2 is directly connected, Loopback0
```

```
3.0.0.0/8 is variably subnetted, 3 subnets, 3 masks
D   3.3.3.3/32 [90/2297856] via 23.23.23.3, 00:02:51, Serial0/1
D   3.3.3.32/29 [90/2297856] via 23.23.23.3, 00:02:51, Serial0/1
D   3.3.3.148/30 [90/2297856] via 23.23.23.3, 00:02:51, Serial0/1
23.0.0.0/24 is subnetted, 1 subnets
C   23.23.23.0 is directly connected, Serial0/1
12.0.0.0/24 is subnetted, 1 subnets
C   12.12.12.0 is directly connected, Serial0/0
R2#
```

```
R1#sh ip route
```

```
Gateway of last resort is not set
```

```
1.0.0.0/32 is subnetted, 1 subnets
C   1.1.1.1 is directly connected, Loopback0
2.0.0.0/32 is subnetted, 1 subnets
D   2.2.2.2 [90/2297856] via 12.12.12.2, 00:03:29, Serial0/0
3.0.0.0/8 is variably subnetted, 2 subnets, 2 masks
D   3.3.3.3/32 [90/2809856] via 12.12.12.2, 00:03:28, Serial0/0
D   3.3.3.96/27 [90/2809856] via 12.12.12.2, 00:03:28, Serial0/0
23.0.0.0/24 is subnetted, 1 subnets
D   23.23.23.0 [90/2681856] via 12.12.12.2, 00:03:29, Serial0/0
12.0.0.0/24 is subnetted, 1 subnets
C   12.12.12.0 is directly connected, Serial0/0
R1#
```

```
R2#sh ip route
```

```
Gateway of last resort is not set
```

```
1.0.0.0/32 is subnetted, 1 subnets
D   1.1.1.1 [90/2297856] via 12.12.12.1, 00:03:15, Serial0/0
2.0.0.0/32 is subnetted, 1 subnets
C   2.2.2.2 is directly connected, Loopback0
3.0.0.0/8 is variably subnetted, 2 subnets, 2 masks
D   3.3.3.3/32 [90/2297856] via 23.23.23.3, 00:03:15, Serial0/1
D   3.3.3.96/27 [90/2297856] via 23.23.23.3, 00:03:15, Serial0/1
23.0.0.0/24 is subnetted, 1 subnets
C   23.23.23.0 is directly connected, Serial0/1
12.0.0.0/24 is subnetted, 1 subnets
C   12.12.12.0 is directly connected, Serial0/0
R2#
```

## EIGRP Filtering - Access List

Access list juga dapat digunakan untuk filtering. Tujuan lab kali ini adalah memfilter route yang genap dan ganjil pada tabel routing.

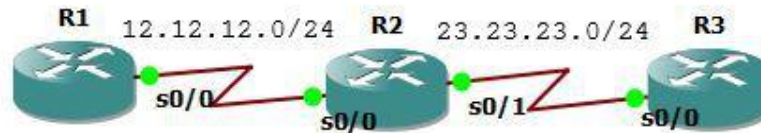

Buat ip loopback ganjil dan genap lalu advertise ke EIGRP.

```
R1(config)#interface Loopback1
R1(config-if)# ip address 11.11.11.1 255.255.255.255
R1(config-if)#!
R1(config-if)#interface Loopback2
R1(config-if)# ip address 11.11.11.2 255.255.255.255
R1(config-if)#!
R1(config-if)#interface Loopback3
R1(config-if)# ip address 11.11.11.3 255.255.255.255
R1(config-if)#!
R1(config-if)#interface Loopback4
R1(config-if)# ip address 11.11.11.4 255.255.255.255
R1(config-if)#!
R1(config-if)#interface Loopback5
R1(config-if)# ip address 11.11.11.5 255.255.255.255
R1(config-if)#!
R1(config-if)#interface Loopback6
R1(config-if)# ip address 11.11.11.6 255.255.255.255
R1(config-if)#!
R1(config-if)#interface Loopback7
R1(config-if)# ip address 11.11.11.7 255.255.255.255
R1(config-if)#!
R1(config-if)#interface Loopback8
R1(config-if)# ip address 11.11.11.8 255.255.255.255
R1(config-if)#!
```

\*\*\*Advertise ke EIGRP\*\*\*

```
R1(config)#router eigrp 10
R1(config-router)# network 11.11.11.1 0.0.0.0
R1(config-router)# network 11.11.11.2 0.0.0.0
R1(config-router)# network 11.11.11.3 0.0.0.0
R1(config-router)# network 11.11.11.4 0.0.0.0
R1(config-router)# network 11.11.11.5 0.0.0.0
R1(config-router)# network 11.11.11.6 0.0.0.0
R1(config-router)# network 11.11.11.7 0.0.0.0
R1(config-router)# network 11.11.11.8 0.0.0.0
```

\*\*\*Cek tabel routing\*\*\*

```
R3(config)#do sh ip route
```

```
Gateway of last resort is not set
```

```
      1.0.0.0/32 is subnetted, 1 subnets
D       1.1.1.1 [90/2809856] via 23.23.23.2, 00:05:40, Serial0/0
```

```

    2.0.0.0/32 is subnetted, 1 subnets
D      2.2.2.2 [90/2297856] via 23.23.23.2, 00:00:03, Serial0/0
    3.0.0.0/32 is subnetted, 1 subnets
C      3.3.3.3 is directly connected, Loopback0
    23.0.0.0/24 is subnetted, 1 subnets
C      23.23.23.0 is directly connected, Serial0/0
    11.0.0.0/32 is subnetted, 8 subnets
D      11.11.11.8 [90/2809856] via 23.23.23.2, 00:00:03, Serial0/0
D      11.11.11.3 [90/2809856] via 23.23.23.2, 00:03:29, Serial0/0
D      11.11.11.2 [90/2809856] via 23.23.23.2, 00:00:04, Serial0/0
D      11.11.11.1 [90/2809856] via 23.23.23.2, 00:03:29, Serial0/0
D      11.11.11.7 [90/2809856] via 23.23.23.2, 00:03:29, Serial0/0
D      11.11.11.6 [90/2809856] via 23.23.23.2, 00:00:06, Serial0/0
D      11.11.11.5 [90/2809856] via 23.23.23.2, 00:03:30, Serial0/0
D      11.11.11.4 [90/2809856] via 23.23.23.2, 00:00:06, Serial0/0
    12.0.0.0/24 is subnetted, 1 subnets
D      12.12.12.0 [90/2681856] via 23.23.23.2, 00:00:06, Serial0/0
R3(config)#

```

### Filter route yang ganjil aja.

```

R3(config)#access-list 10 permit 0.0.0.1 255.255.255.254
R3(config)#router eigrp 10
R3(config-router)#distribute-list 10 in s0/0

```

Gateway of last resort is not set

```

    1.0.0.0/32 is subnetted, 1 subnets
D      1.1.1.1 [90/2809856] via 23.23.23.2, 00:07:25, Serial0/0
    3.0.0.0/32 is subnetted, 1 subnets
C      3.3.3.3 is directly connected, Loopback0
    23.0.0.0/24 is subnetted, 1 subnets
C      23.23.23.0 is directly connected, Serial0/0
    11.0.0.0/32 is subnetted, 4 subnets
D      11.11.11.3 [90/2809856] via 23.23.23.2, 00:05:12, Serial0/0
D      11.11.11.1 [90/2809856] via 23.23.23.2, 00:05:13, Serial0/0
D      11.11.11.7 [90/2809856] via 23.23.23.2, 00:05:14, Serial0/0
D      11.11.11.5 [90/2809856] via 23.23.23.2, 00:05:14, Serial0/0
R3(config)#

```

### Filter route yang genap aja.

```

R3(config)#access-list 10 permit 0.0.0.0 255.255.255.254
R3(config)#router eigrp 10
R3(config-router)#distribute-list 10 in s0/0
R3(config)#
*Mar  1 00:14:41.751: %DUAL-5-NBRCHANGE: IP-EIGRP(0) 10: Neighbor 23.23.23.2
(Serial0/0) is resync: route configuration changed

```

```
R3(config)#do sh ip route
```

Gateway of last resort is not set

```

    2.0.0.0/32 is subnetted, 1 subnets
D      2.2.2.2 [90/2297856] via 23.23.23.2, 00:02:26, Serial0/0
    3.0.0.0/32 is subnetted, 1 subnets
C      3.3.3.3 is directly connected, Loopback0
    23.0.0.0/24 is subnetted, 1 subnets

```

```

C      23.23.23.0 is directly connected, Serial0/0
      11.0.0.0/32 is subnetted, 4 subnets
D      11.11.11.8 [90/2809856] via 23.23.23.2, 00:02:26, Serial0/0
D      11.11.11.2 [90/2809856] via 23.23.23.2, 00:02:26, Serial0/0
D      11.11.11.6 [90/2809856] via 23.23.23.2, 00:02:28, Serial0/0
D      11.11.11.4 [90/2809856] via 23.23.23.2, 00:02:28, Serial0/0
      12.0.0.0/24 is subnetted, 1 subnets
D      12.12.12.0 [90/2681856] via 23.23.23.2, 00:02:28, Serial0/0
R3(config)#

```

## EIGRP Filtering – Administrative Distance

Untuk memfilter route dengan mengeset Administrative Distance (AD) menjadi 255. Maka route tidak akan masuk tabel routing.

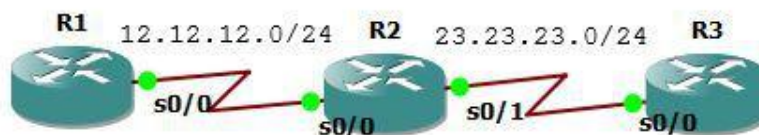

Buat interface loopback dan advertise ke network.

```

R3(config)#int lo1
R3(config-if)#ip add 33.33.33.33 255.255.255.255

R3(config-if)#router eigrp 10
R3(config-router)#network 33.33.33.33 0.0.0.0

```

Pastikan sudah ter-advertise.

```

R2#sh ip route
Codes: C - connected, S - static, R - RIP, M - mobile, B - BGP
       D - EIGRP, EX - EIGRP external, O - OSPF, IA - OSPF inter area
       N1 - OSPF NSSA external type 1, N2 - OSPF NSSA external type 2
       E1 - OSPF external type 1, E2 - OSPF external type 2
       i - IS-IS, su - IS-IS summary, L1 - IS-IS level-1, L2 - IS-IS level-2
       ia - IS-IS inter area, * - candidate default, U - per-user static
       route
       o - ODR, P - periodic downloaded static route

Gateway of last resort is not set

      1.0.0.0/32 is subnetted, 1 subnets
D      1.1.1.1 [90/2297856] via 12.12.12.1, 00:04:36, Serial0/0
      2.0.0.0/32 is subnetted, 1 subnets
C      2.2.2.2 is directly connected, Loopback0
      33.0.0.0/32 is subnetted, 1 subnets
D      33.33.33.33 [90/2297856] via 23.23.23.3, 00:00:12, Serial0/1
      3.0.0.0/32 is subnetted, 1 subnets
D      3.3.3.3 [90/2297856] via 23.23.23.3, 00:00:12, Serial0/1
      23.0.0.0/24 is subnetted, 1 subnets
C      23.23.23.0 is directly connected, Serial0/1

```

```

    11.0.0.0/32 is subnetted, 8 subnets
D       11.11.11.8 [90/2297856] via 12.12.12.1, 00:02:56, Serial0/0
D       11.11.11.3 [90/2297856] via 12.12.12.1, 00:02:56, Serial0/0
D       11.11.11.2 [90/2297856] via 12.12.12.1, 00:02:58, Serial0/0
D       11.11.11.1 [90/2297856] via 12.12.12.1, 00:02:58, Serial0/0
D       11.11.11.7 [90/2297856] via 12.12.12.1, 00:02:57, Serial0/0
D       11.11.11.6 [90/2297856] via 12.12.12.1, 00:02:58, Serial0/0
D       11.11.11.5 [90/2297856] via 12.12.12.1, 00:02:58, Serial0/0
D       11.11.11.4 [90/2297856] via 12.12.12.1, 00:02:58, Serial0/0
    12.0.0.0/24 is subnetted, 1 subnets
C       12.12.12.0 is directly connected, Serial0/0
R2#ping 3.3.3.3

Type escape sequence to abort.
Sending 5, 100-byte ICMP Echos to 3.3.3.3, timeout is 2 seconds:
!!!!
Success rate is 100 percent (5/5), round-trip min/avg/max = 64/82/96 ms
R2#

```

**Dengan mengeset distance 255 pada network 33.33.33.33 di R2, maka network 33.33.33.33 tidak akan muncul pada tabel routing R2. Ketika dicek, network 33.33.33.33 sudah tidak ada.**

```

R2(config)#access-list 33 permit 33.33.33.33
R2(config)#router eigrp 10
R2(config-router)#distance 255 0.0.0.0 255.255.255.255 33

R2(config-router)#do sh ip route

Gateway of last resort is not set

    1.0.0.0/32 is subnetted, 1 subnets
D       1.1.1.1 [90/2297856] via 12.12.12.1, 00:00:13, Serial0/0
    2.0.0.0/32 is subnetted, 1 subnets
C       2.2.2.2 is directly connected, Loopback0
    3.0.0.0/32 is subnetted, 1 subnets
D       3.3.3.3 [90/2297856] via 23.23.23.3, 00:00:13, Serial0/1
    23.0.0.0/24 is subnetted, 1 subnets
C       23.23.23.0 is directly connected, Serial0/1
    11.0.0.0/32 is subnetted, 8 subnets
D       11.11.11.8 [90/2297856] via 12.12.12.1, 00:00:13, Serial0/0
D       11.11.11.3 [90/2297856] via 12.12.12.1, 00:00:15, Serial0/0
D       11.11.11.2 [90/2297856] via 12.12.12.1, 00:00:15, Serial0/0
D       11.11.11.1 [90/2297856] via 12.12.12.1, 00:00:15, Serial0/0
D       11.11.11.7 [90/2297856] via 12.12.12.1, 00:00:18, Serial0/0
D       11.11.11.6 [90/2297856] via 12.12.12.1, 00:00:18, Serial0/0
D       11.11.11.5 [90/2297856] via 12.12.12.1, 00:00:18, Serial0/0
D       11.11.11.4 [90/2297856] via 12.12.12.1, 00:00:18, Serial0/0
    12.0.0.0/24 is subnetted, 1 subnets
C       12.12.12.0 is directly connected, Serial0/0
R2(config-router)#do ping 33.33.33.33

Type escape sequence to abort.
Sending 5, 100-byte ICMP Echos to 33.33.33.33, timeout is 2 seconds:
.....
Success rate is 0 percent (0/5)
R2(config-router)#

```

## EIGRP Authentication

Untuk memberikan autentikasi pada EIGRP dengan mengeset password, Authentication akan mencegah router untuk menerima update packet dari sembarang router EIGRP.

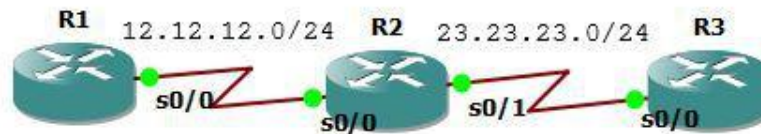

Set authentication pada R1 dan R2.

```
R1(config)#key chain EIGRP
R1(config-keychain)#key 1
R1(config-keychain-key)#key-string CISCO
R1(config-keychain-key)#int s0/0
R1(config-if)#ip authentication mode eigrp 10 md5
R1(config-if)#ip authentication key-chain eigrp 10 EIGRP
*Mar 1 00:00:31.507: %DUAL-5-NBRCHANGE: IP-EIGRP(0) 10: Neighbor 12.12.12.2
(Serial0/0) is down: authentication mode changed
```

```
R2(config)#key chain EIGRP
R2(config-keychain)#key 1
R2(config-keychain-key)#key-string CISCO
R2(config-keychain-key)#int s0/0
R2(config-if)#ip authentication mode eigrp 10 md5
R2(config-if)#ip authentication key-chain eigrp 10 EIGRP
R2(config-if)#
*Mar 1 00:00:31.911: %DUAL-5-NBRCHANGE: IP-EIGRP(0) 10: Neighbor 12.12.12.1
(Serial0/0) is down: authentication mode changed
```

Lakukan debug untuk pengecekan.

```
R1#debug eigrp packets
EIGRP Packets debugging is on
(UPDATE, REQUEST, QUERY, REPLY, HELLO, IPXSAP, PROBE, ACK, STUB,
SIAQUERY, SIAREPLY)
R1#
*Mar 1 00:01:15.211: EIGRP: received packet with MD5 authentication, key id
= 1
*Mar 1 00:01:15.215: EIGRP: Received HELLO on Serial0/0 nbr 12.12.12.2
*Mar 1 00:01:15.215: AS 10, Flags 0x0, Seq 0/0 idbQ 0/0 iidbQ un/rely 0/0
peerQ un/rely 0/0
R1#
*Mar 1 00:01:18.395: EIGRP: Sending HELLO on Serial0/0
*Mar 1 00:01:18.395: AS 10, Flags 0x0, Seq 0/0 idbQ 0/0 iidbQ un/rely 0/0
*Mar 1 00:01:18.419: EIGRP: Sending HELLO on Loopback0
*Mar 1 00:01:18.419: AS 10, Flags 0x0, Seq 0/0 idbQ 0/0 iidbQ un/rely 0/0
*Mar 1 00:01:18.423: EIGRP: Received HELLO on Loopback0 nbr 1.1.1.1
*Mar 1 00:01:18.423: AS 10, Flags 0x0, Seq 0/0 idbQ 0/0
*Mar 1 00:01:18.427: EIGRP: Packet from ourselves ignored
R1#
*Mar 1 00:01:27.315: EIGRP: Sending HELLO on Serial0/0
```

```
*Mar 1 00:01:27.315: AS 10, Flags 0x0, Seq 0/0 idbQ 0/0 iidbQ un/rely 0/0
*Mar 1 00:01:27.655: EIGRP: Sending HELLO on Loopback0
*Mar 1 00:01:27.655: AS 10, Flags 0x0, Seq 0/0 idbQ 0/0 iidbQ un/rely 0/0
*Mar 1 00:01:27.659: EIGRP: Received HELLO on Loopback0 nbr 1.1.1.1
*Mar 1 00:01:27.663: AS 10, Flags 0x0, Seq 0/0 idbQ 0/0
```

## Matikan debug EIGRP.

```
R1#undebug eigrp packets
EIGRP Packets debugging is off
```

## Cek adjacency EIGRP.

```
R1#sh ip eigrp neighbors
IP-EIGRP neighbors for process 10
```

H	Address	Interface	Hold Uptime (sec)	SRTT (ms)	RTO	Q Cnt	Seq Num
0	12.12.12.2	Se0/0	11 00:02:43	27	200	0	8

```
R1#
```

## EIGRP Summarization

Summarization digunakan untuk meringkas beberapa route menjadi satu route. Fungsinya untuk mengurangi size dari routing table dan mengurangi update routing.

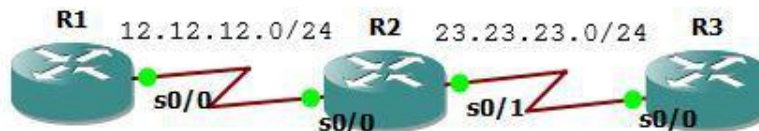

## Buat interface loopback pada R2 untuk diadvertise ke EIGRP.

```
R2(config)#interface Loopback1
R2(config-if)# ip address 22.22.22.1 255.255.255.255
R2(config-if)#!
R2(config-if)#interface Loopback2
R2(config-if)# ip address 22.22.22.2 255.255.255.255
R2(config-if)#!
R2(config-if)#interface Loopback3
R2(config-if)# ip address 22.22.22.3 255.255.255.255
R2(config-if)#!
R2(config-if)#interface Loopback4
R2(config-if)# ip address 22.22.22.4 255.255.255.255
R2(config-if)#!
R2(config-if)#interface Loopback5
R2(config-if)# ip address 22.22.22.5 255.255.255.255
R2(config-if)#!
R2(config-if)#interface Loopback6
R2(config-if)# ip address 22.22.22.6 255.255.255.255
R2(config-if)#!
R2(config-if)#interface Loopback7
R2(config-if)# ip address 22.22.22.7 255.255.255.255
```



```

R2(config-if)#!
R2(config-if)#interface Loopback8
R2(config-if)# ip address 22.22.22.8 255.255.255.255
R2(config-if)#!

R2(config-if)#router eigrp 10
R2(config-router)# network 22.22.22.1 0.0.0.0
R2(config-router)# network 22.22.22.2 0.0.0.0
R2(config-router)# network 22.22.22.3 0.0.0.0
R2(config-router)# network 22.22.22.4 0.0.0.0
R2(config-router)# network 22.22.22.5 0.0.0.0
R2(config-router)# network 22.22.22.6 0.0.0.0
R2(config-router)# network 22.22.22.7 0.0.0.0
R2(config-router)# network 22.22.22.8 0.0.0.0

```

### Cek di R1 dan R3.

```

R3#show ip route

Gateway of last resort is not set

    1.0.0.0/32 is subnetted, 1 subnets
D       1.1.1.1 [90/2809856] via 23.23.23.2, 00:07:53, Serial0/0
    2.0.0.0/32 is subnetted, 1 subnets
D       2.2.2.2 [90/2297856] via 23.23.23.2, 00:07:53, Serial0/0
    3.0.0.0/32 is subnetted, 1 subnets
C       3.3.3.3 is directly connected, Loopback0
    23.0.0.0/24 is subnetted, 1 subnets
C       23.23.23.0 is directly connected, Serial0/0
    22.0.0.0/32 is subnetted, 8 subnets
D       22.22.22.6 [90/2297856] via 23.23.23.2, 00:00:28, Serial0/0
D       22.22.22.7 [90/2297856] via 23.23.23.2, 00:00:31, Serial0/0
D       22.22.22.4 [90/2297856] via 23.23.23.2, 00:00:31, Serial0/0
D       22.22.22.5 [90/2297856] via 23.23.23.2, 00:00:31, Serial0/0
D       22.22.22.2 [90/2297856] via 23.23.23.2, 00:00:32, Serial0/0
D       22.22.22.3 [90/2297856] via 23.23.23.2, 00:00:32, Serial0/0
D       22.22.22.1 [90/2297856] via 23.23.23.2, 00:00:32, Serial0/0
D       22.22.22.8 [90/2297856] via 23.23.23.2, 00:00:31, Serial0/0
    12.0.0.0/24 is subnetted, 1 subnets
D       12.12.12.0 [90/2681856] via 23.23.23.2, 00:07:57, Serial0/0
R3#

```

### Konfigurasi summarization di interface s0/1 pada R2.

```

R2(config-router)# int s0/1
R2(config-if)#ip summary-address eigrp 10 22.22.22.0 255.255.255.248
R2(config-if)#
*Mar  1 00:13:09.727: %DUAL-5-NBRCHANGE: IP-EIGRP(0) 10: Neighbor 23.23.23.3
(Serial0/1) is resync: summary configured

```

### Cek di R3.

```

R3#sh ip route

Gateway of last resort is not set

    1.0.0.0/32 is subnetted, 1 subnets
D       1.1.1.1 [90/2809856] via 23.23.23.2, 00:13:36, Serial0/0
    2.0.0.0/32 is subnetted, 1 subnets

```

```

D      2.2.2.2 [90/2297856] via 23.23.23.2, 00:13:36, Serial0/0
      3.0.0.0/32 is subnetted, 1 subnets
C      3.3.3.3 is directly connected, Loopback0
      23.0.0.0/24 is subnetted, 1 subnets
C      23.23.23.0 is directly connected, Serial0/0
      22.0.0.0/8 is variably subnetted, 2 subnets, 2 masks
D      22.22.22.0/29 [90/2297856] via 23.23.23.2, 00:00:38, Serial0/0
D      22.22.22.8/32 [90/2297856] via 23.23.23.2, 00:06:13, Serial0/0
      12.0.0.0/24 is subnetted, 1 subnets
D      12.12.12.0 [90/2681856] via 23.23.23.2, 00:13:39, Serial0/0
R3#ping 22.22.22.1

Type escape sequence to abort.
Sending 5, 100-byte ICMP Echos to 22.22.22.1, timeout is 2 seconds:
!!!!
Success rate is 100 percent (5/5), round-trip min/avg/max = 60/96/152 ms
R3#ping 22.22.22.8

Type escape sequence to abort.
Sending 5, 100-byte ICMP Echos to 22.22.22.8, timeout is 2 seconds:
!!!!
Success rate is 100 percent (5/5), round-trip min/avg/max = 32/52/92 ms
R3#

```

## EIGRP Unicast Update

Secara default EIGRP melakukan update melalui ip multicast 224.0.0.10, unicast update mengganti update dari multicast ke unicast neighbornya.

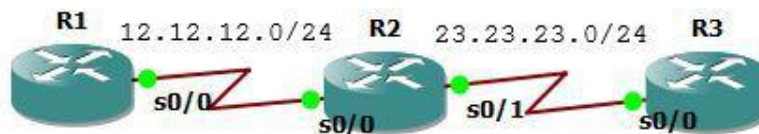

Cek bahwa EIGRP mengirim update secara multicast. IP multicast adalah 244.0.0.10

```

R1#debug ip packet detail
IP packet debugging is on (detailed)
R1#
*Mar 1 00:00:57.331: IP: s=12.12.12.2 (Serial0/0), d=224.0.0.10, len 60,
rcvd 2, proto=88
*Mar 1 00:00:58.079: IP: s=1.1.1.1 (local), d=224.0.0.10 (Loopback0), len
60, sending broad/multicast, proto=88
*Mar 1 00:00:58.083: IP: s=1.1.1.1 (Loopback0), d=224.0.0.10, len 60, rcvd
2, proto=88
R1#
*Mar 1 00:01:00.271: IP: s=12.12.12.1 (local), d=224.0.0.10 (Serial0/0),
len 60, sending broad/multicast, proto=88
R1#

```

```
*Mar 1 00:01:03.019: IP: s=1.1.1.1 (local), d=224.0.0.10 (Loopback0), len
60, sending broad/multicast, proto=88
*Mar 1 00:01:03.023: IP: s=1.1.1.1 (Loopback0), d=224.0.0.10, len 60, rcvd
2, proto=88
R1#undebug ip packet detail
IP packet debugging is off (detailed)
```

### Konfigurasi link R1 ke R2 menjadi unicast.

```
R1(config)#router eigrp 10
R1(config-router)#neighbor 12.12.12.2 s0/0
R1(config-router)#
*Mar 1 00:09:36.483: %DUAL-5-NBRCHANGE: IP-EIGRP(0) 10: Neighbor 12.12.12.2
(Serial0/0) is down: Static peer configured
R1(config-router)#

R2(config)#router eigrp 10
R2(config-router)#neighbor 12.12.12.1 s0/0
```

### Cek debug lagi harusnya sudah ganti unicast.

```
R1#debug ip packet detail
IP packet debugging is on (detailed)
R1#
*Mar 1 00:15:51.467: IP: tableid=0, s=12.12.12.2 (Serial0/0), d=12.12.12.1
(Serial0/0), routed via RIB
*Mar 1 00:15:51.471: IP: s=12.12.12.2 (Serial0/0), d=12.12.12.1
(Serial0/0), len 60, rcvd 3, proto=88
R1#
R1#undebug ip packet detail
IP packet debugging is off (detailed)
R1#
```

## EIGRP Default Route – Summary Address

Agar setiap router tidak perlu membuat konfigurasi default route satu persatu secara manual.

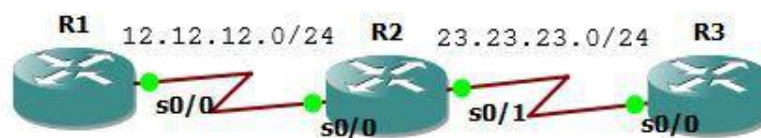

```
R1(config)#int s0/0
R1(config-if)#ip sum
R1(config-if)#ip summary-address eig
R1(config-if)#ip summary-address eigrp 10 0.0.0.0 0.0.0.0
R1(config-if)#
*Mar 1 00:01:20.419: %DUAL-5-NBRCHANGE: IP-EIGRP(0) 10: Neighbor 12.12.12.2
(Serial0/0) is resync: summary configured
```

Cek di R1.

```

R1(config-if)#do sh ip route

Gateway of last resort is 0.0.0.0 to network 0.0.0.0

  1.0.0.0/32 is subnetted, 1 subnets
C    1.1.1.1 is directly connected, Loopback0
  2.0.0.0/32 is subnetted, 1 subnets
D    2.2.2.2 [90/2297856] via 12.12.12.2, 00:01:15, Serial0/0
  3.0.0.0/32 is subnetted, 1 subnets
D    3.3.3.3 [90/2809856] via 12.12.12.2, 00:01:14, Serial0/0
 23.0.0.0/24 is subnetted, 1 subnets
D    23.23.23.0 [90/2681856] via 12.12.12.2, 00:01:15, Serial0/0
 22.0.0.0/32 is subnetted, 8 subnets
D    22.22.22.6 [90/2297856] via 12.12.12.2, 00:01:17, Serial0/0
D    22.22.22.7 [90/2297856] via 12.12.12.2, 00:01:17, Serial0/0
D    22.22.22.4 [90/2297856] via 12.12.12.2, 00:01:17, Serial0/0
D    22.22.22.5 [90/2297856] via 12.12.12.2, 00:01:17, Serial0/0
D    22.22.22.2 [90/2297856] via 12.12.12.2, 00:01:18, Serial0/0
D    22.22.22.3 [90/2297856] via 12.12.12.2, 00:01:18, Serial0/0
D    22.22.22.1 [90/2297856] via 12.12.12.2, 00:01:18, Serial0/0
D    22.22.22.8 [90/2297856] via 12.12.12.2, 00:01:18, Serial0/0
 12.0.0.0/24 is subnetted, 1 subnets
C    12.12.12.0 is directly connected, Serial0/0
D*  0.0.0.0/0 is a summary, 00:00:17, Null0

```

Pada default route aka nada Null0. Null0 berfungsi mendrop packet yang tidak ditemukan tujuannya karena default route.

## EIGRP Redistribution – RIP

Untuk meredistribute RIP ke dalam EIGRP.

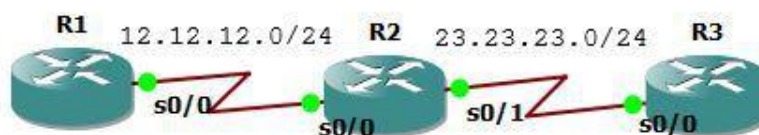

Buat interface loopback di R1 dan advertise ke dalam RIP.

```

R1(config-if)#int lo1
R1(config-if)#ip add 111.111.111.111 255.255.255.255

R1(config-if)#router rip
R1(config-router)#version 2
R1(config-router)#network 111.111.111.0
R1(config-router)#no auto-summary

```

Redistribute RIP ke EIGRP.

```

R2(config)#ipv6 unicast-routing
R2(config)#int fa0/0
R2(config-if)#ipv6 rip 17 enable

```

```
R2(config-if)#int fa0/1
R2(config-if)#ipv6 rip 17 enable
```

## Redistribute RIP ke EIGRP.

```
R1(config)#router eigrp 10
R1(config-router)#redistribute rip metric 1 1 1 1 1
```

## Cek tabel routing dan tes ping.

```
R1#sh ip route
```

```
Gateway of last resort is not set
```

```
    1.0.0.0/32 is subnetted, 1 subnets
C       1.1.1.1 is directly connected, Loopback0
    2.0.0.0/32 is subnetted, 1 subnets
D       2.2.2.2 [90/2297856] via 12.12.12.2, 00:25:20, Serial0/0
    3.0.0.0/32 is subnetted, 1 subnets
D       3.3.3.3 [90/2809856] via 12.12.12.2, 00:25:20, Serial0/0
    23.0.0.0/24 is subnetted, 1 subnets
D       23.23.23.0 [90/2681856] via 12.12.12.2, 00:25:20, Serial0/0
    111.0.0.0/32 is subnetted, 1 subnets
C       111.111.111.111 is directly connected, Loopback1
    12.0.0.0/24 is subnetted, 1 subnets
C       12.12.12.0 is directly connected, Serial0/0
R1#
```

```
R3#sh ip route
```

```
Gateway of last resort is not set
```

```
    1.0.0.0/32 is subnetted, 1 subnets
D       1.1.1.1 [90/2809856] via 23.23.23.2, 00:13:37, Serial0/0
    2.0.0.0/32 is subnetted, 1 subnets
D       2.2.2.2 [90/2297856] via 23.23.23.2, 00:13:38, Serial0/0
    3.0.0.0/32 is subnetted, 1 subnets
C       3.3.3.3 is directly connected, Loopback0
    23.0.0.0/24 is subnetted, 1 subnets
C       23.23.23.0 is directly connected, Serial0/0
    111.0.0.0/32 is subnetted, 1 subnets
D EX    111.111.111.111 [170/2561024256] via 23.23.23.2, 00:00:06, Serial0/0
    12.0.0.0/24 is subnetted, 1 subnets
D       12.12.12.0 [90/2681856] via 23.23.23.2, 00:13:40, Serial0/0
R3#ping 111.111.111.111
```

```
Type escape sequence to abort.
```

```
Sending 5, 100-byte ICMP Echos to 111.111.111.111, timeout is 2 seconds:
!!!!
```

```
Success rate is 100 percent (5/5), round-trip min/avg/max = 52/98/248 ms
R3#
```

Tanda EX menunjukkan bahwa route dihasilkan dengan proses redistribute.

## EIGRP Redistribution - OSPF

Untuk meredistribute OSPF ke dalam EIGRP.

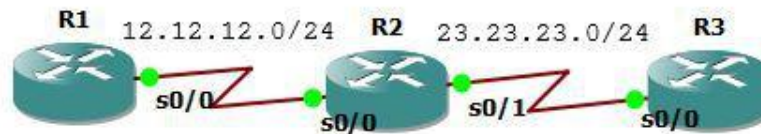

Buat interface loopback di R2 dan advertise ke dalam OSPF.

```
R2(config)#int lo1
R2(config-if)#ip add 22
R2(config-if)#ip add 222.222.222.222 255.255.255.255

R2(config-if)#router ospf 11
R2(config-router)#net 222.222.222.222 0.0.0.0 area 0
```

Redistribute OSPF ke EIGRP.

```
R2(config)#router eigrp 10
R2(config-router)#redistribute ospf 11 metric 1 1 1 1 1
```

Cek tabel routing dan tes ping.

```
R1#sh ip route

Gateway of last resort is not set

    222.222.222.0/32 is subnetted, 1 subnets
D EX    222.222.222.222 [170/2560512256] via 12.12.12.2, 00:00:52, Serial0/0
    1.0.0.0/32 is subnetted, 1 subnets
C       1.1.1.1 is directly connected, Loopback0
    2.0.0.0/32 is subnetted, 1 subnets
D       2.2.2.2 [90/2297856] via 12.12.12.2, 00:05:14, Serial0/0
    3.0.0.0/32 is subnetted, 1 subnets
D       3.3.3.3 [90/2809856] via 12.12.12.2, 00:05:14, Serial0/0
    23.0.0.0/24 is subnetted, 1 subnets
D       23.23.23.0 [90/2681856] via 12.12.12.2, 00:05:17, Serial0/0
    111.0.0.0/32 is subnetted, 1 subnets
C       111.111.111.111 is directly connected, Loopback1
    12.0.0.0/24 is subnetted, 1 subnets
C       12.12.12.0 is directly connected, Serial0/0
R1#ping 222.222.222.222

Type escape sequence to abort.
Sending 5, 100-byte ICMP Echos to 222.222.222.222, timeout is 2 seconds:
!!!!
Success rate is 100 percent (5/5), round-trip min/avg/max = 40/64/92 ms
R1#
```

## EIGRP Path Selection - Delay

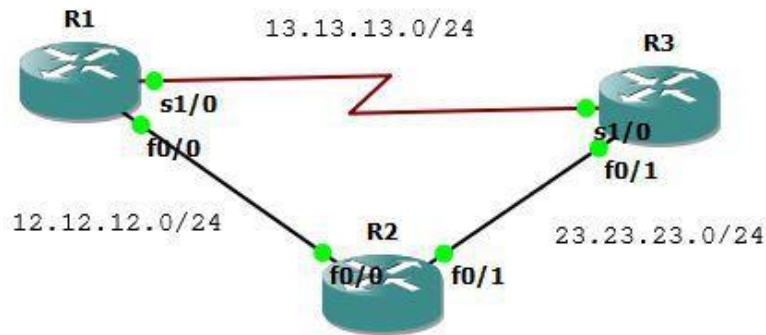

Buatlah topologi seperti diatas dan lakukan konfigurasi interface dan EIGRP.

```
R1(config)#int lo0
R1(config-if)#ip add 1.1.1.1 255.255.255.255
R1(config-if)#int s1/0
R1(config-if)#ip add 13.13.13.1 255.255.255.0
R1(config-if)#no sh
R1(config-if)#int f0/0
R1(config-if)#ip add 12.12.12.1 255.255.255.0
R1(config-if)#no sh
R1(config-if)#router eigrp 13
R1(config-router)#net 1.1.1.1 0.0.0.0
R1(config-router)#net 13.13.13.1 0.0.0.0
R1(config-router)#net 12.12.12.1 0.0.0.0
R1(config-router)#no au
```

```
R2(config)#int lo0
R2(config-if)#ip add 2.2.2.2 255.255.255.255
R2(config-if)#int f0/0
R2(config-if)#ip add 12.12.12.2 255.255.255.0
R2(config-if)#no sh
R2(config-if)#int fa0/1
R2(config-if)#ip add 23.23.23.2 255.255.255.0
R2(config-if)#no sh
R2(config-if)#router eigrp 13
R2(config-router)#net 2.2.2.2 0.0.0.0
R2(config-router)#net 12.12.12.2 0.0.0.0
R2(config-router)#net 23.23.23.2 0.0.0.0
R2(config-router)#no au
```

```
R3(config)#int lo0
R3(config-if)#ip add 3.3.3.3 255.255.255.255
R3(config-if)#int s1/0
R3(config-if)#ip add 13.13.13.3 255.255.255.0
R3(config-if)#no sh
R3(config-if)#int f0/1
R3(config-if)#ip add 23.23.23.3 255.255.255.0
R3(config-if)#router eigrp 13
R3(config-router)#net 3.3.3.3 0.0.0.0
R3(config-router)#net 13.13.13.3 0.0.0.0
R3(config-router)#net 23.23.23.3 0.0.0.0
```

```
R3(config-router)#no au
```

```
R2(config)#ipv6 router eigrp 13
R2(config-rtr)#router-id 2.2.2.2
R2(config-rtr)#no shut
*Mar 1 00:33:55.991: %DUAL-5-NBRCHANGE: IPv6-EIGRP(0) 13: Neighbor
FE80::C203:3FF:FEA8:1 (FastEthernet0/1) is up: new adjacency
*Mar 1 00:34:25.179: %DUAL-5-NBRCHANGE: IPv6-EIGRP(0) 13: Neighbor
FE80::C201:9FF:FED0:0 (FastEthernet0/0) is up: new adjacency
R2(config-rtr)#int lo0
R2(config-if)#ipv6 eigrp 13
R2(config-rtr)#int fa0/0
R2(config-if)#ipv6 eigrp 13
R2(config-rtr)#int fa0/1
R2(config-if)#ipv6 eigrp 13
```

### Mengetahui route yang digunakan ke 3.3.3.3.

```
R1#sh ip route 3.3.3.3
Routing entry for 3.3.3.3/32
  Known via "eigrp 13", distance 90, metric 435200, type internal
  Redistributing via eigrp 13
  Last update from 12.12.12.2 on FastEthernet0/0, 00:04:36 ago
  Routing Descriptor Blocks:
  * 12.12.12.2, from 12.12.12.2, 00:04:36 ago, via FastEthernet0/0
    Route metric is 435200, traffic share count is 1
    Total delay is 7000 microseconds, minimum bandwidth is 10000 Kbit
    Reliability 255/255, minimum MTU 1500 bytes
    Loading 1/255, Hops 2
```

### Mengetahui semua route yang digunakan ke 3.3.3.3 dengan EIGRP.

```
R1#sh ip eigrp top 3.3.3.3 255.255.255.255
IP-EIGRP (AS 13): Topology entry for 3.3.3.3/32
  State is Passive, Query origin flag is 1, 1 Successor(s), FD is 435200
  Routing Descriptor Blocks:
  12.12.12.2 (FastEthernet0/0), from 12.12.12.2, Send flag is 0x0
    Composite metric is (435200/409600), Route is Internal
    Vector metric:
      Minimum bandwidth is 10000 Kbit
      Total delay is 7000 microseconds
      Reliability is 255/255
      Load is 1/255
      Minimum MTU is 1500
      Hop count is 2
  13.13.13.3 (Serial1/0), from 13.13.13.3, Send flag is 0x0
    Composite metric is (2297856/128256), Route is Internal
    Vector metric:
      Minimum bandwidth is 1544 Kbit
      Total delay is 25000 microseconds
      Reliability is 255/255
      Load is 1/255
      Minimum MTU is 1500
      Hop count is 1
```



Ternyata EIGRP lebih memilih FastEthernet daripada Serial. Hal ini dikarenakan bandwidth FastEthernet lebih besar. Untuk menjadikan Serial menjadi link utama dapat dilakukan dengan mengubah delay.

```
R1(config)#int fa0/0
R1(config-if)#delay 100000
R1(config-if)#do clear ip eigrp neighbor

*Mar 1 00:22:45.311: %DUAL-5-NBRCHANGE: IP-EIGRP(0) 13: Neighbor 13.13.13.3
(Serial1/0) is down: manually cleared
*Mar 1 00:22:45.327: %DUAL-5-NBRCHANGE: IP-EIGRP(0) 13: Neighbor 12.12.12.2
(FastEthernet0/0) is down: manually cleared
*Mar 1 00:22:45.863: %DUAL-5-NBRCHANGE: IP-EIGRP(0) 13: Neighbor 12.12.12.2
(FastEthernet0/0) is up: new adjacency
*Mar 1 00:22:46.551: %DUAL-5-NBRCHANGE: IP-EIGRP(0) 13: Neighbor 13.13.13.3
(Serial1/0) is up: new adjacency
*Mar 1 00:23:01.507: %SYS-5-CONFIG_I: Configured from console by console
```

Sekarang cek lagi dan jalur sudah berpindah melalui Serial1/0.

```
R1#sh ip eigrp top 3.3.3.3 255.255.255.255
IP-EIGRP (AS 13): Topology entry for 3.3.3.3/32
  State is Passive, Query origin flag is 1, 1 Successor(s), FD is 2297856
  Routing Descriptor Blocks:
  13.13.13.3 (Serial1/0), from 13.13.13.3, Send flag is 0x0
    Composite metric is (2297856/128256), Route is Internal
    Vector metric:
      Minimum bandwidth is 1544 Kbit
      Total delay is 25000 microseconds
      Reliability is 255/255
      Load is 1/255
      Minimum MTU is 1500
      Hop count is 1
  12.12.12.2 (FastEthernet0/0), from 12.12.12.2, Send flag is 0x0
    Composite metric is (26009600/409600), Route is Internal
    Vector metric:
      Minimum bandwidth is 10000 Kbit
      Total delay is 1006000 microseconds
      Reliability is 255/255
      Load is 1/255
      Minimum MTU is 1500
      Hop count is 2
R1#sh ip route 3.3.3.3
Routing entry for 3.3.3.3/32
  Known via "eigrp 13", distance 90, metric 2297856, type internal
  Redistributing via eigrp 13
  Last update from 13.13.13.3 on Serial1/0, 00:00:43 ago
  Routing Descriptor Blocks:
  * 13.13.13.3, from 13.13.13.3, 00:00:43 ago, via Serial1/0
    Route metric is 2297856, traffic share count is 1
    Total delay is 25000 microseconds, minimum bandwidth is 1544 Kbit
    Reliability 255/255, minimum MTU 1500 bytes
    Loading 1/255, Hops 1

R1#traceroute 3.3.3.3

Type escape sequence to abort.
```

```
Tracing the route to 3.3.3.3
```

```
 1 13.13.13.3 140 msec 4 msec 68 msec  
R1#traceroute 2.2.2.2
```

```
Type escape sequence to abort.  
Tracing the route to 2.2.2.2
```

```
 1 13.13.13.3 172 msec 72 msec 72 msec  
 2 23.23.23.2 140 msec 144 msec 72 msec  
R1#
```

## EIGRP Path Selection - Bandwidth

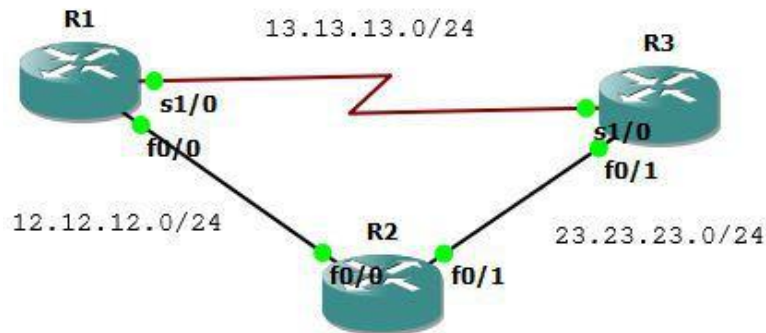

Selain menggunakan delay, dapat juga menggunakan bandwidth.

Hapus dulu konfigurasi delay sebelumnya sehingga route berubah seperti semula.

```
R1(config)#int f0/0  
R1(config-if)#no delay 100000  
R1(config-if)#do sh ip eigrp top 3.3.3.3 255.255.255.255  
IP-EIGRP (AS 13): Topology entry for 3.3.3.3/32  
State is Passive, Query origin flag is 1, 1 Successor(s), FD is 435200  
Routing Descriptor Blocks:  
12.12.12.2 (FastEthernet0/0), from 12.12.12.2, Send flag is 0x0  
Composite metric is (435200/409600), Route is Internal  
Vector metric:  
Minimum bandwidth is 10000 Kbit  
Total delay is 7000 microseconds  
Reliability is 255/255  
Load is 1/255  
Minimum MTU is 1500  
Hop count is 2  
13.13.13.3 (Serial1/0), from 13.13.13.3, Send flag is 0x0  
Composite metric is (2297856/128256), Route is Internal  
Vector metric:  
Minimum bandwidth is 1544 Kbit  
Total delay is 25000 microseconds  
Reliability is 255/255  
Load is 1/255
```

```
Minimum MTU is 1500
Hop count is 1
```

## Ubah bandwidth.

```
R1(config-if)#bandwidth 1000
R1(config-if)#do clear ip eigrp neighbor
```

## Sekarang cek lagi.

```
R1(config-if)#do sh ip eigrp top 3.3.3.3 255.255.255.255
IP-EIGRP (AS 13): Topology entry for 3.3.3.3/32
  State is Passive, Query origin flag is 1, 1 Successor(s), FD is 2297856
  Routing Descriptor Blocks:
  13.13.13.3 (Serial1/0), from 13.13.13.3, Send flag is 0x0
    Composite metric is (2297856/128256), Route is Internal
    Vector metric:
      Minimum bandwidth is 1544 Kbit
      Total delay is 25000 microseconds
      Reliability is 255/255
      Load is 1/255
      Minimum MTU is 1500
      Hop count is 1
  12.12.12.2 (FastEthernet0/0), from 12.12.12.2, Send flag is 0x0
    Composite metric is (2739200/409600), Route is Internal
    Vector metric:
      Minimum bandwidth is 1000 Kbit
      Total delay is 7000 microseconds
      Reliability is 255/255
      Load is 1/255
      Minimum MTU is 1500
      Hop count is 2
```

```
R1(config-if)#
```

```
R1#sh ip route
```

```
Gateway of last resort is not set
```

```
    1.0.0.0/32 is subnetted, 1 subnets
C       1.1.1.1 is directly connected, Loopback0
    2.0.0.0/32 is subnetted, 1 subnets
D       2.2.2.2 [90/2323456] via 13.13.13.3, 00:00:27, Serial1/0
    3.0.0.0/32 is subnetted, 1 subnets
D       3.3.3.3 [90/2297856] via 13.13.13.3, 00:00:27, Serial1/0
    23.0.0.0/24 is subnetted, 1 subnets
D       23.23.23.0 [90/2195456] via 13.13.13.3, 00:00:27, Serial1/0
    12.0.0.0/24 is subnetted, 1 subnets
C       12.12.12.0 is directly connected, FastEthernet0/0
    13.0.0.0/24 is subnetted, 1 subnets
C       13.13.13.0 is directly connected, Serial1/0
R1#traceroute 3.3.3.3
```

```
Type escape sequence to abort.
Tracing the route to 3.3.3.3
```

```
  1 13.13.13.3 152 msec 140 msec 72 msec
R1#traceroute 2.2.2.2
```

```
Type escape sequence to abort.  
Tracing the route to 2.2.2.2
```

```
 1 13.13.13.3 184 msec 44 msec 16 msec  
 2 23.23.23.2 140 msec 96 msec 36 msec
```

## EIGRP Equal Load Balancing

Secara default EIGRP akan menerapkan load balancing pada link yang equal. Pada topologi dibawah dari R1 menuju R3 dapat menggunakan 2 jalur dan semuanya FastEthernet.

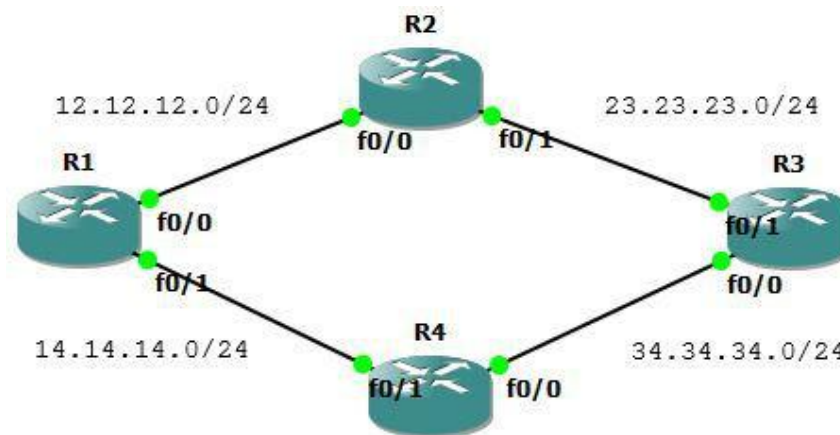

Buat topologi diatas dan lakukan konfigurasi berikut.

```
R1(config)#int lo0  
R1(config-if)#ip add 1.1.1.1 255.255.255.255  
R1(config-if)#int f0/0  
R1(config-if)#ip add 12.12.12.1 255.255.255.0  
R1(config-if)#no sh  
R1(config-if)#int fa0/1  
R1(config-if)#ip add 14.14.14.1 255.255.255.0  
R1(config-if)#no sh  
R1(config-if)#router eigrp 16  
R1(config-router)#net 0.0.0.0  
R1(config-router)#no au  
  
R2(config)#int lo0  
R2(config-if)#ip add 2.2.2.2 255.255.255.255  
R2(config-if)#int fa0/0  
R2(config-if)#ip add 12.12.12.2 255.255.255.0  
R2(config-if)#no sh  
R2(config-if)#int f0/1  
R2(config-if)#ip add 23.23.23.2 255.255.255.0  
R2(config-if)#no sh  
R2(config-if)#router eigrp 16  
R2(config-router)#net 0.0.0.0  
R2(config-router)#no au
```

```

R3(config)#int lo0
R3(config-if)#ip add 3.3.3.3 255.255.255.255
R3(config-if)#int f0/1
R3(config-if)#ip add 23.23.23.3 255.255.255.0
R3(config-if)#no sh
R3(config-if)#int fa0/0
R3(config-if)#ip add 34.34.34.3 255.255.255.0
R3(config-if)#no sh
R3(config-if)#router eigrp 16
R3(config-router)#net 0.0.0.0
R3(config-router)#no au

```

```

R4(config)#int lo0
R4(config-if)#ip add 4.4.4.4 255.255.255.255
R4(config-if)#int f0/1
R4(config-if)#ip add 14.14.14.4 255.255.255.0
R4(config-if)#no sh
R4(config-if)#int fa0/0
R4(config-if)#ip add 34.34.34.4 255.255.255.0
R4(config-if)#no sh
R4(config-if)#router eigrp 16
R4(config-router)#net 0.0.0.0
R4(config-router)#no au

```

### Cek routing tabel dan route menuju 3.3.3.3 dari R1.

```
R1#sh ip route
```

```
Gateway of last resort is not set
```

```

      34.0.0.0/24 is subnetted, 1 subnets
D       34.34.34.0 [90/307200] via 14.14.14.4, 00:01:13, FastEthernet0/1
      1.0.0.0/32 is subnetted, 1 subnets
C       1.1.1.1 is directly connected, Loopback0
      2.0.0.0/32 is subnetted, 1 subnets
D       2.2.2.2 [90/409600] via 12.12.12.2, 00:01:17, FastEthernet0/0
      3.0.0.0/32 is subnetted, 1 subnets
D       3.3.3.3 [90/435200] via 14.14.14.4, 00:01:16, FastEthernet0/1
          [90/435200] via 12.12.12.2, 00:01:16, FastEthernet0/0
      4.0.0.0/32 is subnetted, 1 subnets
D       4.4.4.4 [90/409600] via 14.14.14.4, 00:01:15, FastEthernet0/1
      23.0.0.0/24 is subnetted, 1 subnets
D       23.23.23.0 [90/307200] via 12.12.12.2, 00:01:18, FastEthernet0/0
      12.0.0.0/24 is subnetted, 1 subnets
C       12.12.12.0 is directly connected, FastEthernet0/0
      14.0.0.0/24 is subnetted, 1 subnets
C       14.14.14.0 is directly connected, FastEthernet0/1

```

```
R1#sh ip route 3.3.3.3
```

```
Routing entry for 3.3.3.3/32
```

```
Known via "eigrp 16", distance 90, metric 435200, type internal
```

```
Redistributing via eigrp 16
```

```
Last update from 12.12.12.2 on FastEthernet0/0, 00:01:42 ago
```

```
Routing Descriptor Blocks:
```

```
* 14.14.14.4, from 14.14.14.4, 00:01:42 ago, via FastEthernet0/1
```

```
Route metric is 435200, traffic share count is 1
```

```
Total delay is 7000 microseconds, minimum bandwidth is 10000 Kbit
```

```
Reliability 255/255, minimum MTU 1500 bytes
Loading 1/255, Hops 2
12.12.12.2, from 12.12.12.2, 00:01:42 ago, via FastEthernet0/0
Route metric is 435200, traffic share count is 1
Total delay is 7000 microseconds, minimum bandwidth is 10000 Kbit
Reliability 255/255, minimum MTU 1500 bytes
Loading 1/255, Hops 2
```

Didapat bahwa 2 jalur digunakan secara bersamaan (load balancing) menuju ke 3.3.3.3. Sekarang lakukan traceroute ke 3.3.3.3.

```
R1#traceroute 3.3.3.3

Type escape sequence to abort.
Tracing the route to 3.3.3.3

 0 14.14.14.4 160 msec
 1 12.12.12.2 172 msec
 2 14.14.14.4 188 msec
 3 23.23.23.3 312 msec
 4 34.34.34.3 216 msec
 5 23.23.23.3 188 msec

R1#
```

## EIGRP Unequal Load Balancing

Pada link yang unequal, maka load balancing tidak aktif dan hanya akan menggunakan satu link.

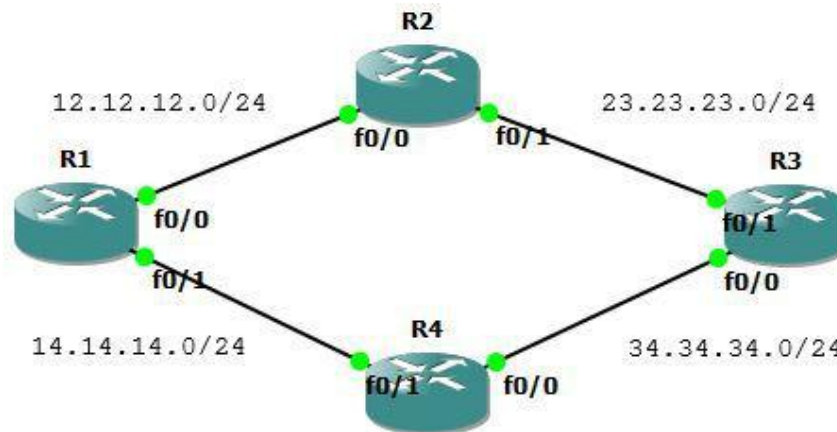

Masih memakai topologi sebelumnya. Sebelumnya ubah bandwidth interface fa0/0 menjadi 1000Kbit agar tidak equal dengan fa0/1.

```
R1(config)#int fa0/0
R1(config-if)#bandwidth 1000
```

Sekarang cek route ke 3.3.3.3 dan hanya melalui satu link.

```
R1(config-if) R1(config-if)#do clear ip route *
R1(config-if)#do sh ip route 3.3.3.3
```

```

Routing entry for 3.3.3.3/32
  Known via "eigrp 16", distance 90, metric 435200, type internal
  Redistributing via eigrp 16
  Last update from 14.14.14.4 on FastEthernet0/1, 00:00:22 ago
  Routing Descriptor Blocks:
  * 14.14.14.4, from 14.14.14.4, 00:00:22 ago, via FastEthernet0/1
    Route metric is 435200, traffic share count is 1
    Total delay is 7000 microseconds, minimum bandwidth is 10000 Kbit
    Reliability 255/255, minimum MTU 1500 bytes
    Loading 1/255, Hops 2

R1(config-if)#do sh ip eigrp top 3.3.3.3/32
IP-EIGRP (AS 16): Topology entry for 3.3.3.3/32
  State is Passive, Query origin flag is 1, 1 Successor(s), FD is 435200
  Routing Descriptor Blocks:
  14.14.14.4 (FastEthernet0/1), from 14.14.14.4, Send flag is 0x0
    Composite metric is (435200/409600), Route is Internal
    Vector metric:
      Minimum bandwidth is 10000 Kbit
      Total delay is 7000 microseconds
      Reliability is 255/255
      Load is 1/255
      Minimum MTU is 1500
      Hop count is 2
  12.12.12.2 (FastEthernet0/0), from 12.12.12.2, Send flag is 0x0
    Composite metric is (2739200/409600), Route is Internal
    Vector metric:
      Minimum bandwidth is 1000 Kbit
      Total delay is 7000 microseconds
      Reliability is 255/255
      Load is 1/255
      Minimum MTU is 1500
      Hop count is 2
R1(config-if)# #do clear ip route

```

Untuk mengaktifkan load balancing, harus dicari nilai variencenya. Varience adalah  $2739200 : 435200 = 6.29412$ , berapapun komanya bulatkan kebawah sehingga menjadi 7.

Dengan nilai varience 7, artinya setiap 7 packet dikirimkan melalui link pertama dan 1 packet melalui link kedua.

Sekarang set nilai variencenya.

```

R1(config-if)#router eigrp 16
R1(config-router)#variance 7

```

Cek apakah sudah load balancing.

```

R1(config-router)#do sh ip route

Gateway of last resort is not set

  34.0.0.0/24 is subnetted, 1 subnets
D       34.34.34.0 [90/307200] via 14.14.14.4, 00:00:17, FastEthernet0/1
  1.0.0.0/32 is subnetted, 1 subnets
C       1.1.1.1 is directly connected, Loopback0

```

```

2.0.0.0/32 is subnetted, 1 subnets
D   2.2.2.2 [90/460800] via 14.14.14.4, 00:00:17, FastEthernet0/1
   [90/2713600] via 12.12.12.2, 00:00:17, FastEthernet0/0
3.0.0.0/32 is subnetted, 1 subnets
D   3.3.3.3 [90/435200] via 14.14.14.4, 00:00:17, FastEthernet0/1
   [90/2739200] via 12.12.12.2, 00:00:19, FastEthernet0/0
4.0.0.0/32 is subnetted, 1 subnets
D   4.4.4.4 [90/409600] via 14.14.14.4, 00:00:19, FastEthernet0/1
23.0.0.0/24 is subnetted, 1 subnets
D   23.23.23.0 [90/332800] via 14.14.14.4, 00:00:20, FastEthernet0/1
12.0.0.0/24 is subnetted, 1 subnets
C   12.12.12.0 is directly connected, FastEthernet0/0
14.0.0.0/24 is subnetted, 1 subnets
C   14.14.14.0 is directly connected, FastEthernet0/1
R1(config-router)#do sh ip route 3.3.3.3
Routing entry for 3.3.3.3/32
  Known via "eigrp 16", distance 90, metric 435200, type internal
  Redistributing via eigrp 16
  Last update from 12.12.12.2 on FastEthernet0/0, 00:00:42 ago
  Routing Descriptor Blocks:
  * 14.14.14.4, from 14.14.14.4, 00:00:42 ago, via FastEthernet0/1
    Route metric is 435200, traffic share count is 120
    Total delay is 7000 microseconds, minimum bandwidth is 10000 Kbit
    Reliability 255/255, minimum MTU 1500 bytes
    Loading 1/255, Hops 2
  12.12.12.2, from 12.12.12.2, 00:00:42 ago, via FastEthernet0/0
    Route metric is 2739200, traffic share count is 19
    Total delay is 7000 microseconds, minimum bandwidth is 1000 Kbit
    Reliability 255/255, minimum MTU 1500 bytes
    Loading 1/255, Hops 2
R1(config-router)#

```

## EIGRP Stub – Connected + Summary

Router stub akan mengadvertise directly connected dan summary route.

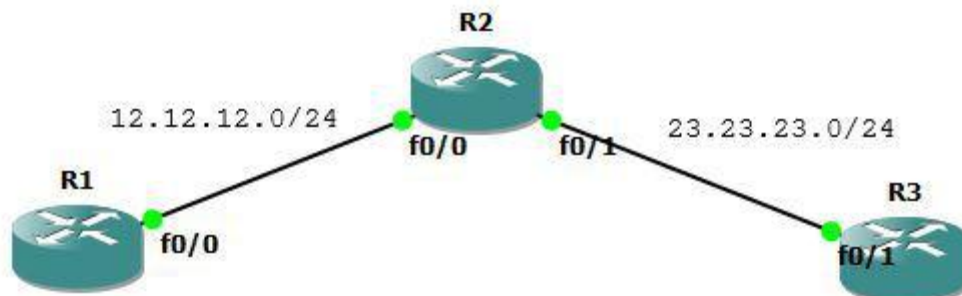

Lakukan konfigurasi berikut.

```

R1
interface Loopback0
ip address 1.1.1.1 255.255.255.255

```



```

!
interface FastEthernet0/0
 ip address 12.12.12.1 255.255.255.0
!
router eigrp 10
 redistribute static
 network 12.12.12.1 0.0.0.0
 no auto-summary
!

R2
interface Loopback0
 ip address 2.2.2.2 255.255.255.255
!
interface Loopback1
 ip address 22.22.21.1 255.255.255.0
!
interface Loopback2
 ip address 22.22.22.1 255.255.255.0
!
interface Loopback3
 ip address 22.22.23.1 255.255.255.0
!
interface Loopback4
 ip address 22.22.24.1 255.255.255.0
!
interface Loopback5
 ip address 22.22.25.1 255.255.255.0
!
interface FastEthernet0/0
 ip address 12.12.12.2 255.255.255.0
!
interface FastEthernet0/1
 ip address 23.23.23.2 255.255.255.0
 ip summary-address eigrp 10 22.22.0.0 255.255.0.0 5
!
router eigrp 10
 redistribute static
 redistribute rip metric 1 1 1 1 1
 network 2.2.2.2 0.0.0.0
 network 12.12.12.2 0.0.0.0
 network 22.22.0.0 0.0.0.0
 network 23.23.23.2 0.0.0.0
 no auto-summary
!
router rip
 network 22.0.0.0
!
ip route 1.1.1.1 255.255.255.255 FastEthernet0/0

R3
interface Loopback0
 ip address 3.3.3.3 255.255.255.255
!
interface FastEthernet0/1
 ip address 23.23.23.3 255.255.255.0
!

```

```
router eigrp 10
 network 3.3.3.3 0.0.0.0
 network 23.23.23.3 0.0.0.0
 no auto-summary
!
```

### Cek tabel routing di R3.

```
R3#sh ip route
```

```
Gateway of last resort is not set
```

```

 1.0.0.0/32 is subnetted, 1 subnets
D EX   1.1.1.1 [170/307200] via 23.23.23.2, 00:00:01, FastEthernet0/1
 2.0.0.0/32 is subnetted, 1 subnets
D       2.2.2.2 [90/409600] via 23.23.23.2, 00:00:01, FastEthernet0/1
 3.0.0.0/32 is subnetted, 1 subnets
C       3.3.3.3 is directly connected, Loopback0
 23.0.0.0/24 is subnetted, 1 subnets
C       23.23.23.0 is directly connected, FastEthernet0/1
 22.0.0.0/16 is subnetted, 1 subnets
D       22.22.0.0 [90/2560025856] via 23.23.23.2, 00:00:04, FastEthernet0/1
 12.0.0.0/24 is subnetted, 1 subnets
D       12.12.12.0 [90/307200] via 23.23.23.2, 00:00:04, FastEthernet0/1
R3#
```

### Sekarang tes masukkan perintah eigrp stub.

```
R2(config-router)#eigrp stub
```

**Cek ip route dan bandingkan dengan sebelumnya. Hanya ada route connected dan summary sedang redistribute sudah terhapus.**

```
R3#sh ip route
```

```
Gateway of last resort is not set
```

```

 2.0.0.0/32 is subnetted, 1 subnets
D       2.2.2.2 [90/409600] via 23.23.23.2, 00:00:06, FastEthernet0/1
 3.0.0.0/32 is subnetted, 1 subnets
C       3.3.3.3 is directly connected, Loopback0
 23.0.0.0/24 is subnetted, 1 subnets
C       23.23.23.0 is directly connected, FastEthernet0/1
 22.0.0.0/16 is subnetted, 1 subnets
D       22.22.0.0 [90/2560025856] via 23.23.23.2, 00:00:06, FastEthernet0/1
 12.0.0.0/24 is subnetted, 1 subnets
D       12.12.12.0 [90/307200] via 23.23.23.2, 00:00:09, FastEthernet0/1
R3#
```

## EIGRP Stub – Connected

Router stub hanya akan mengadvertise directly connected route.

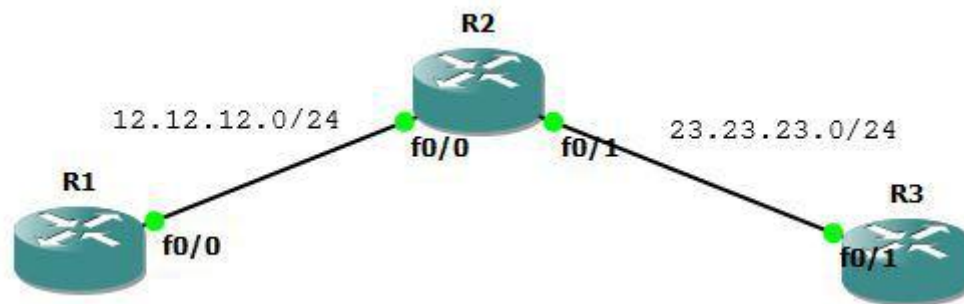

Lanjutan lab sebelumnya. Hapus dulu perintah eigrp stub sebelumnya.

```
R2(config)#router eigrp 10
R2(config-router)#no eigrp stub
```

Cek ip route dan tabel routing sudah kembali seperti semua. Masukkan eigrp stub connected.

```
R3#sh ip route
```

```
Gateway of last resort is not set
```

```
1.0.0.0/32 is subnetted, 1 subnets
D EX 1.1.1.1 [170/307200] via 23.23.23.2, 00:00:46, FastEthernet0/1
2.0.0.0/32 is subnetted, 1 subnets
D 2.2.2.2 [90/409600] via 23.23.23.2, 00:00:46, FastEthernet0/1
3.0.0.0/32 is subnetted, 1 subnets
C 3.3.3.3 is directly connected, Loopback0
23.0.0.0/24 is subnetted, 1 subnets
C 23.23.23.0 is directly connected, FastEthernet0/1
22.0.0.0/16 is subnetted, 1 subnets
D 22.22.0.0 [90/2560025856] via 23.23.23.2, 00:00:46, FastEthernet0/1
12.0.0.0/24 is subnetted, 1 subnets
D 12.12.12.0 [90/307200] via 23.23.23.2, 00:00:48, FastEthernet0/1
R3#
```

```
R2(config-router)# eigrp stub connected
```

```
*Mar 1 00:06:02.587: %DUAL-5-NBRCHANGE: IP-EIGRP(0) 10: Neighbor 12.12.12.1
(FastEthernet0/0) is down: peer info changed
*Mar 1 00:06:02.599: %DUAL-5-NBRCHANGE: IP-EIGRP(0) 10: Neighbor 23.23.23.3
(FastEthernet0/1) is down: peer info changed
```

Cek lagi ip route.

```
R3#sh ip route
```

```
Gateway of last resort is not set
```

```
2.0.0.0/32 is subnetted, 1 subnets
D 2.2.2.2 [90/409600] via 23.23.23.2, 00:00:12, FastEthernet0/1
3.0.0.0/32 is subnetted, 1 subnets
C 3.3.3.3 is directly connected, Loopback0
23.0.0.0/24 is subnetted, 1 subnets
```

```
C      23.23.23.0 is directly connected, FastEthernet0/1
      12.0.0.0/24 is subnetted, 1 subnets
D      12.12.12.0 [90/307200] via 23.23.23.2, 00:00:12, FastEthernet0/1
R3#
```

## EIGRP Stub – Summary

Router stub hanya akan mengadvertise summary route.

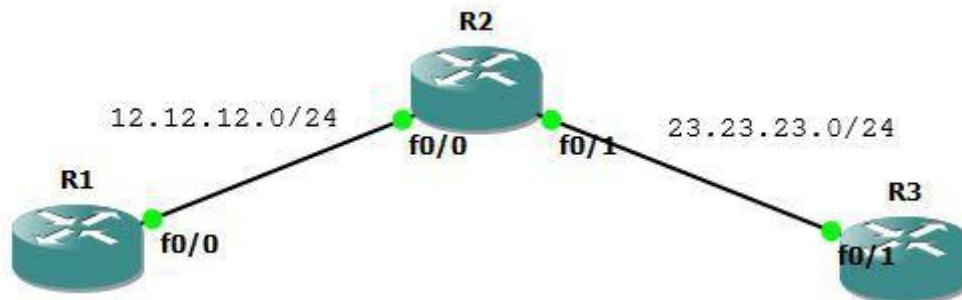

```
R2(config)#router eigrp 10
R2(config-router)#no eigrp stub
R2(config-router)# eigrp stub summary
```

```
R3#sh ip route
```

```
Gateway of last resort is not set
```

```
      3.0.0.0/32 is subnetted, 1 subnets
C      3.3.3.3 is directly connected, Loopback0
      23.0.0.0/24 is subnetted, 1 subnets
C      23.23.23.0 is directly connected, FastEthernet0/1
      22.0.0.0/16 is subnetted, 1 subnets
D      22.22.0.0 [90/2560025856] via 23.23.23.2, 00:00:27, FastEthernet0/1
R3#
```

## EIGRP Stub – Static

Router stub akan mengadvertise static route.

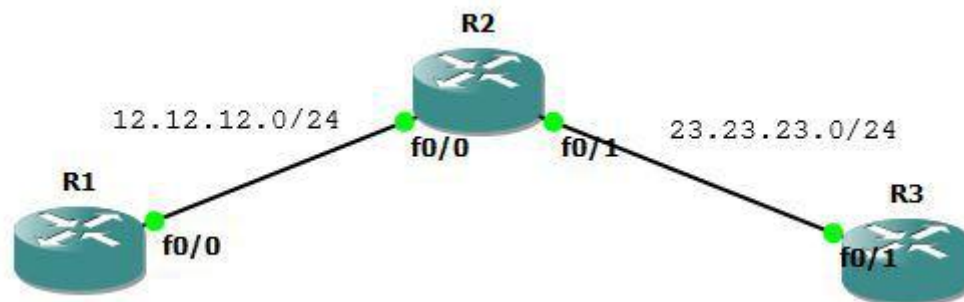

```
R2(config)#router eigrp 10
R2(config-router)#no eigrp stub
R2(config-router)#eigrp stub static
```

```
R3#sh ip route
```

```
Gateway of last resort is not set
```

```
1.0.0.0/32 is subnetted, 1 subnets
D EX 1.1.1.1 [170/307200] via 23.23.23.2, 00:00:28, FastEthernet0/1
3.0.0.0/32 is subnetted, 1 subnets
C 3.3.3.3 is directly connected, Loopback0
23.0.0.0/24 is subnetted, 1 subnets
C 23.23.23.0 is directly connected, FastEthernet0/1
R3#
```

## EIGRP Stub – Redistributed

Router stub akan mengadvertise redistributed route.

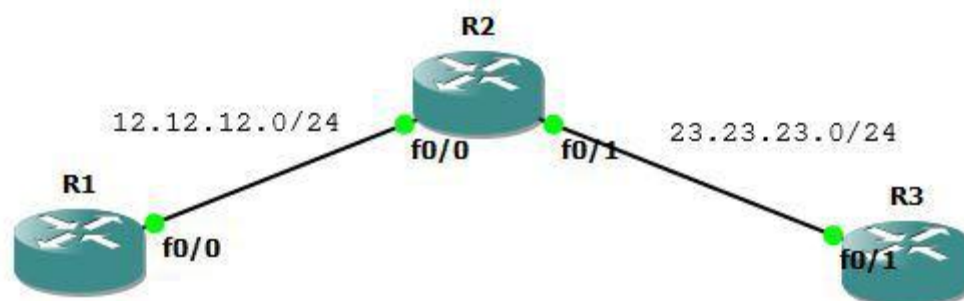

```
R2(config)#router eigrp 10
R2(config-router)#no eigrp stub
R2(config-router)#eigrp stub redistributed
```

```
R3#sh ip route
```

```
Gateway of last resort is not set
```

```
1.0.0.0/32 is subnetted, 1 subnets
D EX 1.1.1.1 [170/307200] via 23.23.23.2, 00:00:02, FastEthernet0/1
2.0.0.0/32 is subnetted, 1 subnets
D 2.2.2.2 [90/409600] via 23.23.23.2, 00:00:02, FastEthernet0/1
3.0.0.0/32 is subnetted, 1 subnets
C 3.3.3.3 is directly connected, Loopback0
23.0.0.0/24 is subnetted, 1 subnets
C 23.23.23.0 is directly connected, FastEthernet0/1
22.0.0.0/16 is subnetted, 1 subnets
D 22.22.0.0 [90/2560025856] via 23.23.23.2, 00:00:02, FastEthernet0/1
12.0.0.0/24 is subnetted, 1 subnets
D 12.12.12.0 [90/307200] via 23.23.23.2, 00:00:05, FastEthernet0/1
R3#
```

## EIGRP Stub – Receive Only

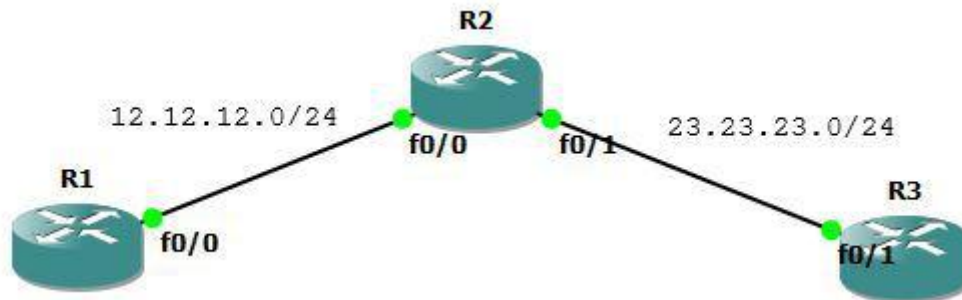

Lanjutan lab sebelumnya. Hapus dulu perintah eigrp stub sebelumnya.

```
R2(config)#router eigrp 10
R2(config-router)#no eigrp stub
R2(config-router)#eigrp stub receive-only
```

```
Gateway of last resort is not set
```

```
3.0.0.0/32 is subnetted, 1 subnets
C 3.3.3.3 is directly connected, Loopback0
23.0.0.0/24 is subnetted, 1 subnets
C 23.23.23.0 is directly connected, FastEthernet0/1
R3#
```

```
R1#sh ip route
```

```
Gateway of last resort is not set
```

```
1.0.0.0/32 is subnetted, 1 subnets
C 1.1.1.1 is directly connected, Loopback0
12.0.0.0/24 is subnetted, 1 subnets
C 12.12.12.0 is directly connected, FastEthernet0/0
```

Protocol Header			
8	16	24	32
Version	Opcode	Checksum	
Flags			
Sequence Number			
Acknowledgment Number			
Autonomous System Number			
Type		Length	
Value			

Attributes	
<b>Type</b>	Distance Vector
<b>Algorithm</b>	DUAL
<b>Internal AD</b>	90
<b>External AD</b>	170
<b>Summary AD</b>	5
<b>Standard</b>	Cisco proprietary
<b>Protocols</b>	IP, IPX, Appletalk
<b>Transport</b>	IP/88
<b>Authentication</b>	MD5
<b>Multicast IP</b>	224.0.0.10
<b>Hello Timers</b>	5/60
<b>Hold Timers</b>	15/180

Metric Formula
$256 * (K_1 * \mathbf{bw} + \frac{K_2 * \mathbf{bw}}{256 - \mathbf{load}} + K_3 * \mathbf{delay}) * \frac{K_5}{\mathbf{rel} + K_4}$
<ul style="list-style-type: none"> <li><b>bw</b> = <math>10^7</math> / minimum path bandwidth in kbps</li> <li><b>delay</b> = interface delay in µsecs / 10</li> </ul>

## EIGRP Configuration

```

Protocol Configuration
! Enable EIGRP
router eigrp <ASN>

! Add networks to advertise
network <IP address> <wildcard mask>

! Configure K values to manipulate metric formula
metric weights 0 <k1> <k2> <k3> <k4> <k5>

! Disable automatic route summarization
no auto-summary

! Designate passive interfaces
passive-interface (<interface> | default)

! Enable stub routing
eigrp stub [receive-only | connected | static | summary]

! Statically identify neighboring routers
neighbor <IP address> <interface>
    
```

```

Interface Configuration
! Set maximum bandwidth EIGRP can consume
ip bandwidth-percent eigrp <AS> <percentage>

! Configure manual summarization of outbound routes
ip summary-address eigrp <AS> <IP address> <mask> [<AD>]

! Enable MD5 authentication
ip authentication mode eigrp <AS> md5
ip authentication key-chain eigrp <AS> <key-chain>

! Configure hello and hold timers
ip hello-interval eigrp <AS> <seconds>
ip hold-time eigrp <AS> <seconds>

! Disable split horizon for EIGRP
no ip split-horizon eigrp <AS>
    
```

K Defaults	Packet Types
<b>K<sub>1</sub></b> 1	<b>1</b> Update
<b>K<sub>2</sub></b> 0	<b>3</b> Query
<b>K<sub>3</sub></b> 1	<b>4</b> Reply
<b>K<sub>4</sub></b> 0	<b>5</b> Hello
<b>K<sub>5</sub></b> 0	<b>8</b> Acknowledge

## Terminology

- Reported Distance**  
The metric for a route advertised by a neighbor
- Feasible Distance**  
The distance advertised by a neighbor plus the cost to get to that neighbor
- Stuck In Active (SIA)**  
The condition when a route becomes unreachable and not all queries for it are answered; adjacencies with unresponsive neighbors are reset
- Passive Interface**  
An interface which does not participate in EIGRP but whose network is advertised
- Stub Router**  
A router which advertises only a subset of routes, and is omitted from the route query process

## Troubleshooting

```

show ip eigrp interfaces
show ip eigrp neighbors
show ip eigrp topology
show ip eigrp traffic
clear ip eigrp neighbors
debug ip eigrp [packet | neighbors]
    
```

# OSPF

- OSPF Basic Configuration
  - OSPF Virtual Link
  - OSPF GRE Tunnel
  - OSPF Standar Area
  - OSPF Stub Area
  - OSPF Totally Stub Area
- OSPF Not So Stubby Area (NSSA)
- OSPF External Route Type 1
- OSPF Summarization – Area Range
- OSPF Summarization – Summary Address
- OSPF Path Selection



# OSPF

## (Open Shortest Path First)

- Open Standard.
- Link-State routing protocol.
- Using SPF/Dijkstra Algorithm.
- Multicast for exchange information use port 89.
- Administrative distance 110.
- Classless routing protocol support VLSM/CIDR.
- Support IPv6.
- Metric using cost.
- Fast convergence.
- Equal load balancing only.
- Using areas (backbone area and non-backbone areas).

Link-state mengetahui peta keseluruhan (topology) dalam jaringan untuk menentukan shortest path.

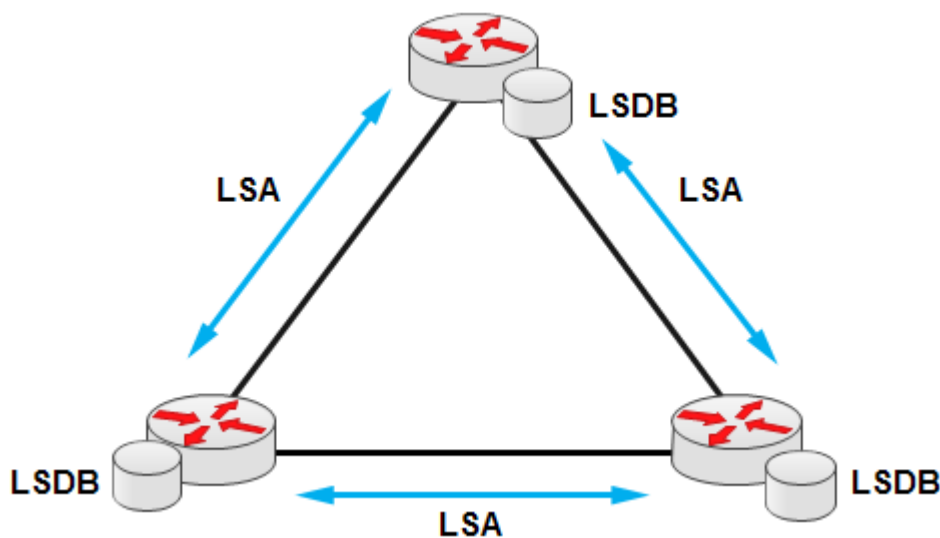

Link = interface dari router.

State = ke router neighbor mana interface tadi terhubung.

Link state router bekerja dengan mengirim link-state advertisement (LSA) ke router link-state lain dan disimpan di link-state database (LSDB). LSA seperti puzzle yang membentuk LSDB. LSDB adalah gambaran keseluruhan jaringan yang

kita sebut topology. Ketika LSDB sudah lengkap, maka OSPF akan menghitung shortest path.

OSPF bekerja dengan konsep area. Area yang harus ada pada OSPF adalah area 0 atau backbone area. Area-area lain (non-backbone area) yang ingin terhubung, harus melalui backbone area.

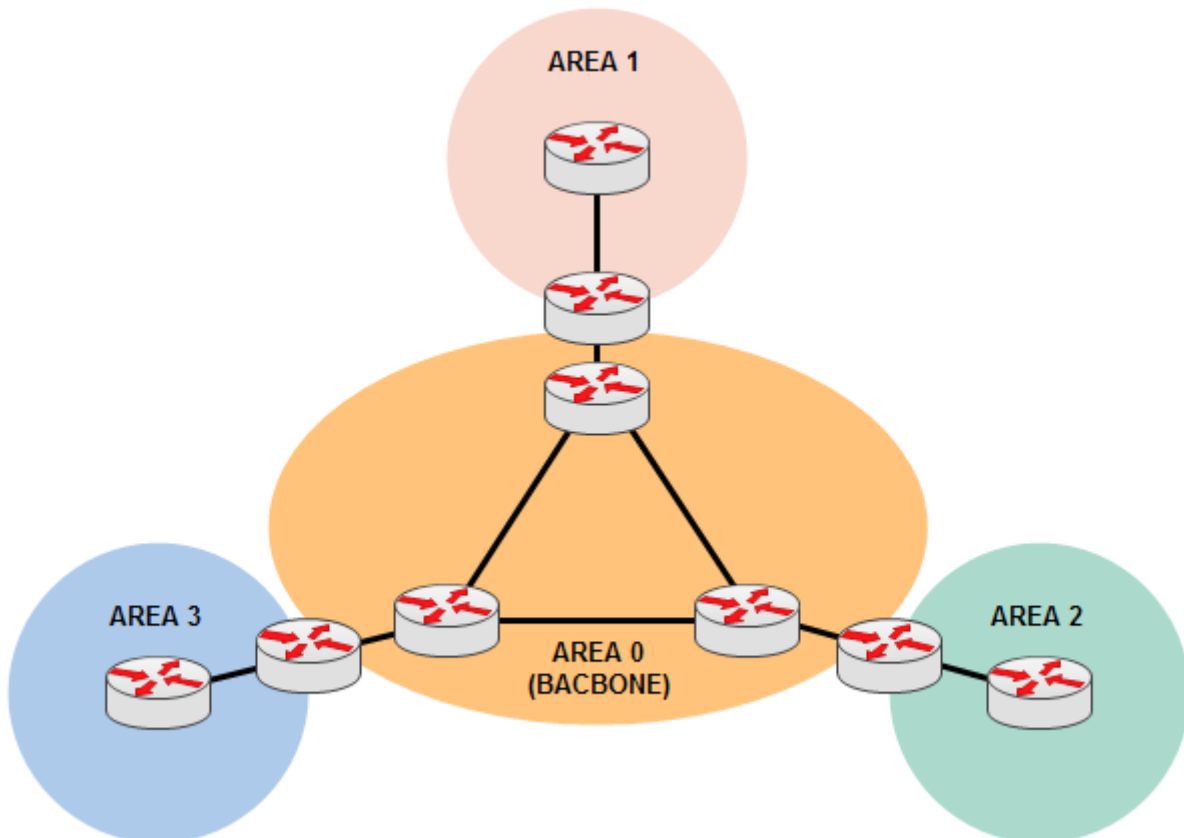

Pembagian area ini bertujuan untuk manajemen traffic dan mengurangi resources yang dipakai oleh router. Ada beberapa jenis router dalam OSPF.

Backbone router = router dalam backbone area.

Area Border Router (ABR) = router dalam 2 area.

Autonomous System Border Router (ASBR) = router yang terhubung ke network lain yang menjalankan routing yang berbeda.

OSPF menggunakan metric yang disebut cost. Cost dihitung berdasarkan bandwidth suatu interface.

$Cost = \text{reference bandwidth} / \text{interface bandwidth}$

Default reference bandwidth adalah 100Mbit, tapi ini bisa diubah karena saat ini sudah ada interface yang sampai giga.

Setiap LSA mempunyai aging timer yaitu batas waktu berlaku. Defaultnya LSA valid selama 30 menit. Setelah itu akan expire dan dikirim lagi LSA baru dengan sequence number yang lebih tinggi.

## OSPF Basic Configuration

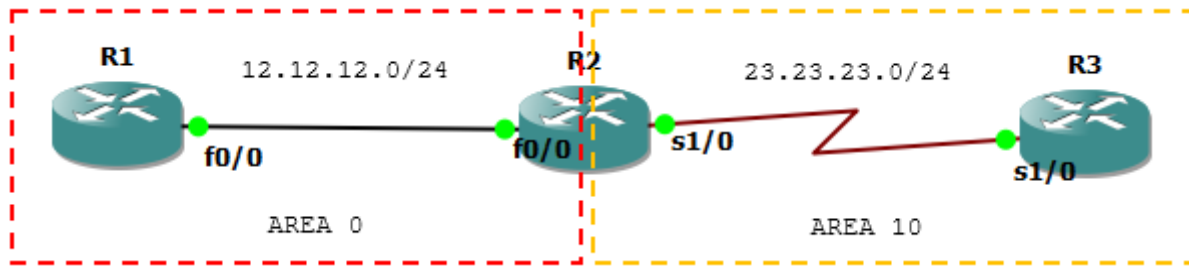

Ketikkan konfigurasi interface berikut.

```
R1
interface Loopback0
 ip address 1.1.1.1 255.255.255.255
!
interface FastEthernet0/0
 ip address 12.12.12.1 255.255.255.0
!
router ospf 13
 router-id 1.1.1.1
 network 1.1.1.1 0.0.0.0 area 0
 network 12.12.12.0 0.0.0.255 area 0
!

R2
interface Loopback0
 ip address 2.2.2.2 255.255.255.255
!
interface FastEthernet0/0
 ip address 12.12.12.2 255.255.255.0
!
interface Serial1/0
 ip address 23.23.23.2 255.255.255.0
!
router ospf 13
 router-id 2.2.2.2
 network 2.2.2.2 0.0.0.0 area 10
 network 12.12.12.0 0.0.0.255 area 0
 network 23.23.23.0 0.0.0.255 area 10
!

R3
interface Loopback0
 ip address 3.3.3.3 255.255.255.255
!
interface Serial1/0
 ip address 23.23.23.3 255.255.255.0
!
router ospf 14
 router-id 3.3.3.3
 network 3.3.3.3 0.0.0.0 area 10
 network 23.23.23.0 0.0.0.255 area 10
!
```

## Cek tabel routing.

```
R1#sh ip route

Gateway of last resort is not set

    1.0.0.0/32 is subnetted, 1 subnets
C       1.1.1.1 is directly connected, Loopback0
    2.0.0.0/32 is subnetted, 1 subnets
O IA    2.2.2.2 [110/11] via 12.12.12.2, 00:07:41, FastEthernet0/0
    3.0.0.0/32 is subnetted, 1 subnets
O IA    3.3.3.3 [110/75] via 12.12.12.2, 00:07:41, FastEthernet0/0
    23.0.0.0/24 is subnetted, 1 subnets
O IA    23.23.23.0 [110/74] via 12.12.12.2, 00:07:41, FastEthernet0/0
    12.0.0.0/24 is subnetted, 1 subnets
C       12.12.12.0 is directly connected, FastEthernet0/0
R1#
```

```
R2#sh ip route

Gateway of last resort is not set

    1.0.0.0/32 is subnetted, 1 subnets
O       1.1.1.1 [110/11] via 12.12.12.1, 00:08:04, FastEthernet0/0
    2.0.0.0/32 is subnetted, 1 subnets
C       2.2.2.2 is directly connected, Loopback0
    3.0.0.0/32 is subnetted, 1 subnets
O       3.3.3.3 [110/65] via 23.23.23.3, 00:08:39, Serial1/0
    23.0.0.0/24 is subnetted, 1 subnets
C       23.23.23.0 is directly connected, Serial1/0
    12.0.0.0/24 is subnetted, 1 subnets
C       12.12.12.0 is directly connected, FastEthernet0/0
R2#
```

```
R3#sh ip route

Gateway of last resort is not set

    1.0.0.0/32 is subnetted, 1 subnets
O IA    1.1.1.1 [110/75] via 23.23.23.2, 00:08:17, Serial1/0
    2.0.0.0/32 is subnetted, 1 subnets
O       2.2.2.2 [110/65] via 23.23.23.2, 00:08:52, Serial1/0
    3.0.0.0/32 is subnetted, 1 subnets
C       3.3.3.3 is directly connected, Loopback0
    23.0.0.0/24 is subnetted, 1 subnets
C       23.23.23.0 is directly connected, Serial1/0
    12.0.0.0/24 is subnetted, 1 subnets
O IA    12.12.12.0 [110/74] via 23.23.23.2, 00:08:52, Serial1/0
R3#
```

## Tes ping.

```
R1#ping 2.2.2.2

Type escape sequence to abort.
Sending 5, 100-byte ICMP Echos to 2.2.2.2, timeout is 2 seconds:
!!!!
Success rate is 100 percent (5/5), round-trip min/avg/max = 8/75/144 ms
```

```
R1#ping 3.3.3.3
```

```
Type escape sequence to abort.
```

```
Sending 5, 100-byte ICMP Echos to 3.3.3.3, timeout is 2 seconds:
```

```
!!!!
```

```
Success rate is 100 percent (5/5), round-trip min/avg/max = 12/128/288 ms
```

```
R1#
```

```
R2#sh ip ospf database
```

```
OSPF Router with ID (2.2.2.2) (Process ID 13)
```

```
Router Link States (Area 0)
```

Link ID	ADV Router	Age	Seq#	Checksum	Link count
1.1.1.1	1.1.1.1	616	0x80000002	0x0015AB	2
2.2.2.2	2.2.2.2	615	0x80000002	0x00F9D1	1

```
Net Link States (Area 0)
```

Link ID	ADV Router	Age	Seq#	Checksum
12.12.12.2	2.2.2.2	615	0x80000001	0x0014EB

```
Summary Net Link States (Area 0)
```

Link ID	ADV Router	Age	Seq#	Checksum
2.2.2.2	2.2.2.2	656	0x80000001	0x00FA31
3.3.3.3	2.2.2.2	646	0x80000001	0x004F98
23.23.23.0	2.2.2.2	656	0x80000001	0x00901F

```
Router Link States (Area 10)
```

Link ID	ADV Router	Age	Seq#	Checksum	Link count
2.2.2.2	2.2.2.2	655	0x80000002	0x009C44	3
3.3.3.3	3.3.3.3	658	0x80000002	0x00BB1D	3

```
Summary Net Link States (Area 10)
```

Link ID	ADV Router	Age	Seq#	Checksum
1.1.1.1	2.2.2.2	613	0x80000001	0x008D98
12.12.12.0	2.2.2.2	658	0x80000001	0x00FF07

```
R2#
```

## OSPF Virtual Link

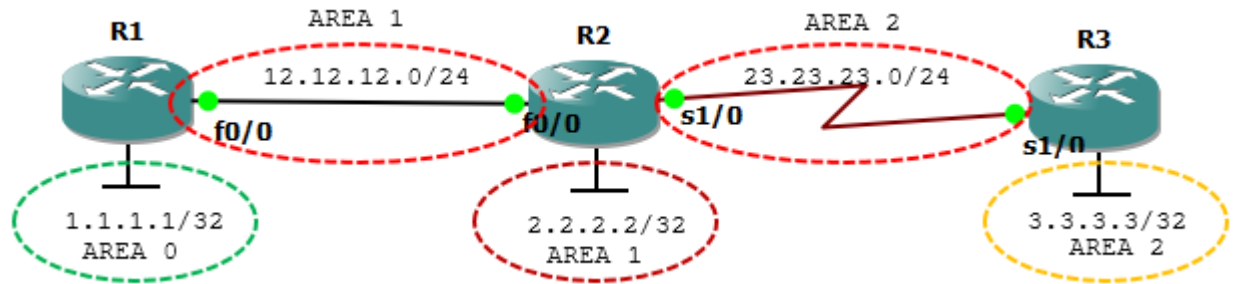

```
R1
interface Loopback0
 ip address 1.1.1.1 255.255.255.255
!
interface FastEthernet0/0
 ip address 12.12.12.1 255.255.255.0
!
router ospf 13
 router-id 1.1.1.1
 network 1.1.1.1 0.0.0.0 area 0
 network 12.12.12.0 0.0.0.255 area 1
!

R2
interface Loopback0
 ip address 2.2.2.2 255.255.255.255
!
interface FastEthernet0/0
 ip address 12.12.12.2 255.255.255.0
!
interface Serial1/0
 ip address 23.23.23.2 255.255.255.0
!
router ospf 13
 router-id 2.2.2.2
 network 2.2.2.2 0.0.0.0 area 1
 network 12.12.12.0 0.0.0.255 area 1
 network 23.23.23.0 0.0.0.255 area 2
!

R3
interface Loopback0
 ip address 3.3.3.3 255.255.255.255
!
interface Serial1/0
 ip address 23.23.23.3 255.255.255.0
!
router ospf 14
 router-id 3.3.3.3
 network 3.3.3.3 0.0.0.0 area 2
 network 23.23.23.0 0.0.0.255 area 2
!
```

## Cek tabel routing.

```
R1(config-router)#do sh ip route
Gateway of last resort is not set

    1.0.0.0/32 is subnetted, 1 subnets
C       1.1.1.1 is directly connected, Loopback0
    2.0.0.0/32 is subnetted, 1 subnets
O       2.2.2.2 [110/11] via 12.12.12.2, 00:00:21, FastEthernet0/0
    12.0.0.0/24 is subnetted, 1 subnets
C       12.12.12.0 is directly connected, FastEthernet0/0
R1(config-router)#

R2(config-router)#do sh ip route
Gateway of last resort is not set

    1.0.0.0/32 is subnetted, 1 subnets
O IA    1.1.1.1 [110/11] via 12.12.12.1, 00:01:33, FastEthernet0/0
    2.0.0.0/32 is subnetted, 1 subnets
C       2.2.2.2 is directly connected, Loopback0
    3.0.0.0/32 is subnetted, 1 subnets
O       3.3.3.3 [110/65] via 23.23.23.3, 00:01:43, Serial1/0
    23.0.0.0/24 is subnetted, 1 subnets
C       23.23.23.0 is directly connected, Serial1/0
    12.0.0.0/24 is subnetted, 1 subnets
C       12.12.12.0 is directly connected, FastEthernet0/0
R2(config-router)#

R3(config-router)#do sh ip route
Gateway of last resort is not set

    3.0.0.0/32 is subnetted, 1 subnets
C       3.3.3.3 is directly connected, Loopback0
    23.0.0.0/24 is subnetted, 1 subnets
C       23.23.23.0 is directly connected, Serial1/0
R3(config-router)#
```

## Cek database OSPF.

```
R1#sh ip ospf database

        OSPF Router with ID (1.1.1.1) (Process ID 13)

        Router Link States (Area 0)

Link ID        ADV Router    Age          Seq#          Checksum Link count
1.1.1.1        1.1.1.1      261         0x80000001   0x00D351 1

        Summary Net Link States (Area 0)

Link ID        ADV Router    Age          Seq#          Checksum
2.2.2.2        1.1.1.1      189         0x80000001   0x007DA8
12.12.12.0     1.1.1.1      257         0x80000001   0x001EEC

        Router Link States (Area 1)

Link ID        ADV Router    Age          Seq#          Checksum Link count
1.1.1.1        1.1.1.1      193         0x80000002   0x00389C 1
```



```

2.2.2.2          2.2.2.2          195          0x80000002 0x00298A 2

      Net Link States (Area 1)

Link ID          ADV Router      Age           Seq#           Checksum
12.12.12.2      2.2.2.2        195          0x80000001 0x0014EB

      Summary Net Link States (Area 1)

Link ID          ADV Router      Age           Seq#           Checksum
1.1.1.1         1.1.1.1        297          0x80000001 0x0047EC
R1#

R3#sh ip ospf database

      OSPF Router with ID (3.3.3.3) (Process ID 14)

      Router Link States (Area 2)

Link ID          ADV Router      Age           Seq#           Checksum Link count
2.2.2.2          2.2.2.2        293          0x80000002 0x00D624 2
3.3.3.3          3.3.3.3        287          0x80000002 0x00BB1D 3
R3#

```

## Konfigurasi virtual link: area area-id virtual-link router-id

```

R1(config)#router ospf 13
R1(config-router)#area 1 virtual-link ?
  A.B.C.D ID (IP addr) associated with virtual link neighbor

R1(config-router)#area 1 virtual-link 2.2.2.2

R2(config-router)#area 1 virtual-link 1.1.1.1
*Mar 1 00:09:45.563: %OSPF-5-ADJCHG: Process 13, Nbr 1.1.1.1 on OSPF_VL0
from LOADING to FULL, Loading Done

R1#sh ip route
Gateway of last resort is not set

    1.0.0.0/32 is subnetted, 1 subnets
C       1.1.1.1 is directly connected, Loopback0
    2.0.0.0/32 is subnetted, 1 subnets
O       2.2.2.2 [110/11] via 12.12.12.2, 00:08:38, FastEthernet0/0
    3.0.0.0/32 is subnetted, 1 subnets
O IA    3.3.3.3 [110/75] via 12.12.12.2, 00:00:48, FastEthernet0/0
    23.0.0.0/24 is subnetted, 1 subnets
O IA    23.23.23.0 [110/74] via 12.12.12.2, 00:00:48, FastEthernet0/0
    12.0.0.0/24 is subnetted, 1 subnets
C       12.12.12.0 is directly connected, FastEthernet0/0
R1#

```

## Network 3.3.3.3 belum ada pada tabel routing.

```

R2(config-router)#area 2 virtual-link 3.3.3.3

R3(config-router)#area 2 virtual-link 2.2.2.2
*Mar 1 00:12:26.355: %OSPF-5-ADJCHG: Process 14, Nbr 2.2.2.2 on OSPF_VL0
from LOADING to FULL, Loading Done

```

Cek lagi

```
R1#sh ip route
Gateway of last resort is not set

    1.0.0.0/32 is subnetted, 1 subnets
C       1.1.1.1 is directly connected, Loopback0
    2.0.0.0/32 is subnetted, 1 subnets
O       2.2.2.2 [110/11] via 12.12.12.2, 00:12:02, FastEthernet0/0
    3.0.0.0/32 is subnetted, 1 subnets
O IA    3.3.3.3 [110/75] via 12.12.12.2, 00:01:34, FastEthernet0/0
    23.0.0.0/24 is subnetted, 1 subnets
O IA    23.23.23.0 [110/74] via 12.12.12.2, 00:04:11, FastEthernet0/0
    12.0.0.0/24 is subnetted, 1 subnets
C       12.12.12.0 is directly connected, FastEthernet0/0
R1#ping 2.2.2.2

Type escape sequence to abort.
Sending 5, 100-byte ICMP Echos to 2.2.2.2, timeout is 2 seconds:
!!!!
Success rate is 100 percent (5/5), round-trip min/avg/max = 56/100/204 ms
R1#ping 3.3.3.3

Type escape sequence to abort.
Sending 5, 100-byte ICMP Echos to 3.3.3.3, timeout is 2 seconds:
!!!!
Success rate is 100 percent (5/5), round-trip min/avg/max = 24/148/204 ms
R1#
```

## Cek virtual link.

```
R1#sh ip ospf virtual-links
Virtual Link OSPF_VL0 to router 2.2.2.2 is up
  Run as demand circuit
  DoNotAge LSA allowed.
  Transit area 1, via interface FastEthernet0/0, Cost of using 10
  Transmit Delay is 1 sec, State POINT_TO_POINT,
  Timer intervals configured, Hello 10, Dead 40, Wait 40, Retransmit 5
    Hello due in 00:00:09
  Adjacency State FULL (Hello suppressed)
  Index 1/2, retransmission queue length 0, number of retransmission 0
  First 0x0(0)/0x0(0) Next 0x0(0)/0x0(0)
  Last retransmission scan length is 0, maximum is 0
  Last retransmission scan time is 0 msec, maximum is 0 msec
R1#

2#sh ip ospf virtual-links
Virtual Link OSPF_VL1 to router 3.3.3.3 is up
  Run as demand circuit
  DoNotAge LSA allowed.
  Transit area 2, via interface Serial1/0, Cost of using 64
  Transmit Delay is 1 sec, State POINT_TO_POINT,
  Timer intervals configured, Hello 10, Dead 40, Wait 40, Retransmit 5
    Hello due in 00:00:07
  Adjacency State FULL (Hello suppressed)
  Index 2/4, retransmission queue length 0, number of retransmission 0
```

```

First 0x0(0)/0x0(0) Next 0x0(0)/0x0(0)
Last retransmission scan length is 0, maximum is 0
Last retransmission scan time is 0 msec, maximum is 0 msec
Virtual Link OSPF_VL0 to router 1.1.1.1 is up
Run as demand circuit
DoNotAge LSA allowed.
Transit area 1, via interface FastEthernet0/0, Cost of using 10
Transmit Delay is 1 sec, State POINT_TO_POINT,
Timer intervals configured, Hello 10, Dead 40, Wait 40, Retransmit 5
Hello due in 00:00:02
Adjacency State FULL (Hello suppressed)
Index 1/3, retransmission queue length 0, number of retransmission 1
First 0x0(0)/0x0(0) Next 0x0(0)/0x0(0)
Last retransmission scan length is 1, maximum is 1
Last retransmission scan time is 0 msec, maximum is 0 msec
R2#

R3#sh ip ospf virtual-links
Virtual Link OSPF_VL0 to router 2.2.2.2 is up
Run as demand circuit
DoNotAge LSA allowed.
Transit area 2, via interface Serial1/0, Cost of using 64
Transmit Delay is 1 sec, State POINT_TO_POINT,
Timer intervals configured, Hello 10, Dead 40, Wait 40, Retransmit 5
Hello due in 00:00:01
Adjacency State FULL (Hello suppressed)
Index 1/2, retransmission queue length 0, number of retransmission 0
First 0x0(0)/0x0(0) Next 0x0(0)/0x0(0)
Last retransmission scan length is 0, maximum is 0
Last retransmission scan time is 0 msec, maximum is 0 msec
R3#

```

## OSPF GRE Tunnel

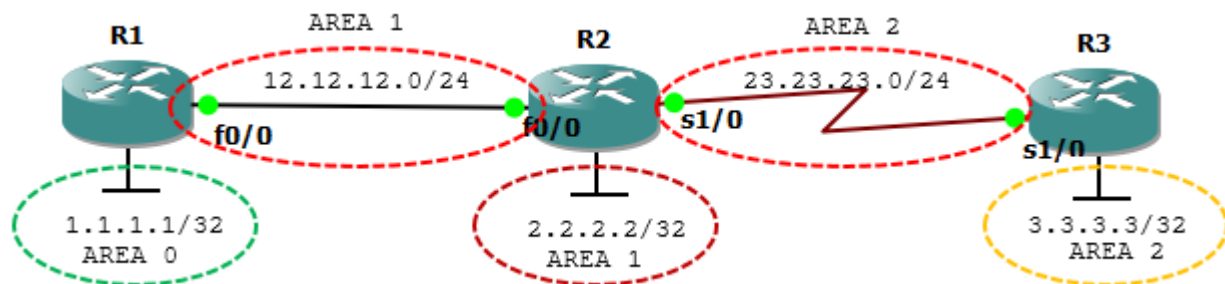

Hapus virtual link terlebih dahulu.

```

R1(config)#router ospf 13
R1(config-router)#no area 1 virtual-link 2.2.2.2

R2(config)#router ospf 13
R2(config-router)#no area 1 virtual-link 1.1.1.1
R2(config-router)#no area 2 virtual-link 3.3.3.3

```

```
R3(config)#router ospf 14
R3(config-router)#no area 2 virtual-link 2.2.2.2
```

## Konfigurasi GRE tunnel.

```
R1(config)#int tun1
R1(config-if)#ip add 102.102.102.1 255.255.255.0
R1(config-if)#tunnel source 12.12.12.1
R1(config-if)#tunnel destination 12.12.12.2
R1(config-if)#router ospf 13
R1(config-router)#net 102.102.102.1 0.0.0.0 area 0
```

```
R2(config)#int tun1
R2(config-if)#ip add 102.102.102.2 255.255.255.0
R2(config-if)#tunnel destination 12.12.12.1
R2(config-if)#tunnel source 12.12.12.2
R2(config-if)#router ospf 13
R2(config-router)#net 102.102.102.2 0.0.0.0 area 0
```

```
R1#sh ip route
```

```
Gateway of last resort is not set
```

```
      102.0.0.0/24 is subnetted, 1 subnets
C       102.102.102.0 is directly connected, Tunnell1
      1.0.0.0/32 is subnetted, 1 subnets
C       1.1.1.1 is directly connected, Loopback0
      2.0.0.0/32 is subnetted, 1 subnets
O       2.2.2.2 [110/11] via 12.12.12.2, 00:11:26, FastEthernet0/0
      3.0.0.0/32 is subnetted, 1 subnets
O IA    3.3.3.3 [110/11176] via 102.102.102.2, 00:03:52, Tunnell1
      23.0.0.0/24 is subnetted, 1 subnets
O IA    23.23.23.0 [110/11175] via 102.102.102.2, 00:03:52, Tunnell1
      12.0.0.0/24 is subnetted, 1 subnets
C       12.12.12.0 is directly connected, FastEthernet0/0
R1#ping 2.2.2.2
```

```
Type escape sequence to abort.
```

```
Sending 5, 100-byte ICMP Echos to 2.2.2.2, timeout is 2 seconds:
```

```
!!!!
```

```
Success rate is 100 percent (5/5), round-trip min/avg/max = 32/96/284 ms
```

```
R1#ping 3.3.3.3
```

```
Type escape sequence to abort.
```

```
Sending 5, 100-byte ICMP Echos to 3.3.3.3, timeout is 2 seconds:
```

```
!!!!
```

```
Success rate is 100 percent (5/5), round-trip min/avg/max = 92/200/312 ms
```

```
R1#
```

```
R1#sh ip int br
```

Interface	IP-Address	OK?	Method	Status
FastEthernet0/0	12.12.12.1	YES	NVRAM	up
up				
FastEthernet0/1	unassigned	YES	NVRAM	administratively down
down				

```

Serial1/0          unassigned      YES NVRAM  administratively down
down
Serial1/1          unassigned      YES NVRAM  administratively down
down
Serial1/2          unassigned      YES NVRAM  administratively down
down
Serial1/3          unassigned      YES NVRAM  administratively down
down
Loopback0         1.1.1.1        YES NVRAM  up
up
Tunnell           102.102.102.1  YES manual up
up
R1#

```

## OSPF Standar Area

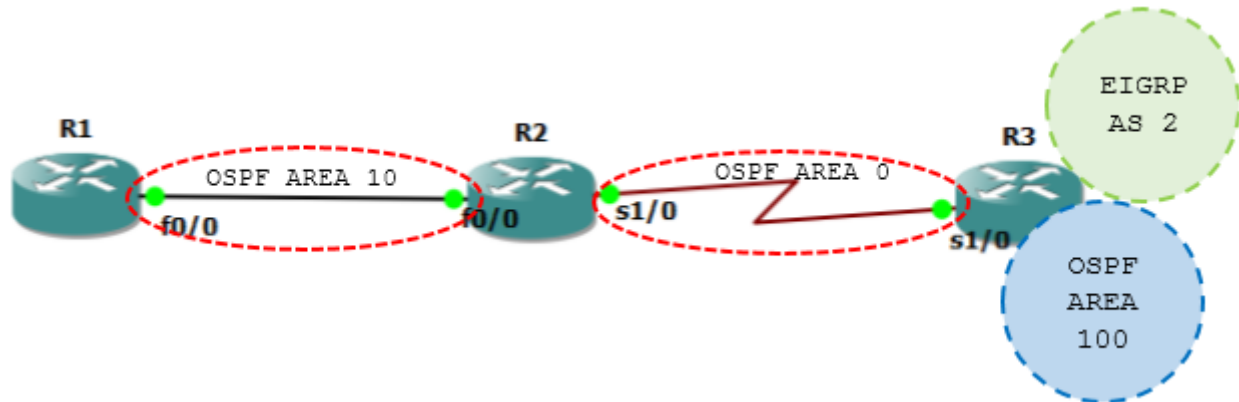

```

R1
interface Loopback0
 ip address 1.1.1.1 255.255.255.255
!
interface FastEthernet0/0
 ip address 12.12.12.1 255.255.255.0
!
router ospf 13
 router-id 1.1.1.1
 network 1.1.1.1 0.0.0.0 area 10
 network 12.12.12.0 0.0.0.255 area 10
!

R2
interface Loopback0
 ip address 2.2.2.2 255.255.255.255
!
interface FastEthernet0/0
 ip address 12.12.12.2 255.255.255.0
!
interface Serial1/0
 ip address 23.23.23.2 255.255.255.0
!

```

```

router ospf 13
  router-id 2.2.2.2
  network 2.2.2.2 0.0.0.0 area 0
  network 12.12.12.0 0.0.0.255 area 10
  network 23.23.23.0 0.0.0.255 area 0
!

R3
interface Loopback0
  ip address 3.3.3.3 255.255.255.255
!
interface Serial1/0
  ip address 23.23.23.3 255.255.255.0
!
router ospf 14
  router-id 3.3.3.3
  network 3.3.3.3 0.0.0.0 area 0
  network 23.23.23.0 0.0.0.255 area 0
!

```

**Buat interface loopback di R3 dan masukkan beberapa interfacenya ke EIGRP.**

```

interface Loopback1
  ip address 33.33.33.1 255.255.255.255
!
interface Loopback2
  ip address 33.33.33.2 255.255.255.255
!
interface Loopback3
  ip address 33.33.33.3 255.255.255.255
!
interface Loopback4
  ip address 33.33.33.4 255.255.255.255
!
interface Loopback5
  ip address 33.33.33.5 255.255.255.255
!
interface Loopback6
  ip address 33.33.33.6 255.255.255.255
!
interface Loopback7
  ip address 33.33.33.7 255.255.255.255
!
interface Loopback8
  ip address 33.33.33.8 255.255.255.255
!

router eigrp 2
  net 33.33.33.1 0.0.0.0
  net 33.33.33.2 0.0.0.0
  net 33.33.33.3 0.0.0.0
  net 33.33.33.4 0.0.0.0
  no auto-summary

```

**Masukkan interface yang lain ke OSPF dengan area 100 dan redistribute EIGRP ke OSPF lalu cek tabel routing R1.**

```

router ospf 14

```

```

net 33.33.33.5 0.0.0.0 area 100
net 33.33.33.6 0.0.0.0 area 100
net 33.33.33.7 0.0.0.0 area 100
net 33.33.33.8 0.0.0.0 area 100
redistribute eigrp 2 subnets

```

Cek R1.

```

R1(config-router)#do sh ip route
Gateway of last resort is not set

    1.0.0.0/32 is subnetted, 1 subnets
C       1.1.1.1 is directly connected, Loopback0
    2.0.0.0/32 is subnetted, 1 subnets
O IA    2.2.2.2 [110/11] via 12.12.12.2, 00:00:28, FastEthernet0/0
    33.0.0.0/32 is subnetted, 8 subnets
O E2    33.33.33.1 [110/20] via 12.12.12.2, 00:00:03, FastEthernet0/0
O E2    33.33.33.3 [110/20] via 12.12.12.2, 00:00:03, FastEthernet0/0
O E2    33.33.33.2 [110/20] via 12.12.12.2, 00:00:03, FastEthernet0/0
O IA    33.33.33.5 [110/75] via 12.12.12.2, 00:00:08, FastEthernet0/0
O E2    33.33.33.4 [110/20] via 12.12.12.2, 00:00:04, FastEthernet0/0
O IA    33.33.33.7 [110/75] via 12.12.12.2, 00:00:09, FastEthernet0/0
O IA    33.33.33.6 [110/75] via 12.12.12.2, 00:00:09, FastEthernet0/0
O IA    33.33.33.8 [110/75] via 12.12.12.2, 00:00:09, FastEthernet0/0
    3.0.0.0/32 is subnetted, 1 subnets
O IA    3.3.3.3 [110/75] via 12.12.12.2, 00:00:11, FastEthernet0/0
    23.0.0.0/24 is subnetted, 1 subnets
O IA    23.23.23.0 [110/74] via 12.12.12.2, 00:00:31, FastEthernet0/0
    12.0.0.0/24 is subnetted, 1 subnets
C       12.12.12.0 is directly connected, FastEthernet0/0
R1(config-router)#

```

```

R1(config-router)#do sh ip ospf database

```

OSPF Router with ID (1.1.1.1) (Process ID 13)

Router Link States (Area 10)

Link ID	ADV Router	Age	Seq#	Checksum	Link count
1.1.1.1	1.1.1.1	127	0x80000002	0x0015AB	2
2.2.2.2	2.2.2.2	127	0x80000002	0x00F9D1	1

Net Link States (Area 10)

Link ID	ADV Router	Age	Seq#	Checksum
12.12.12.2	2.2.2.2	127	0x80000001	0x0014EB

Summary Net Link States (Area 10)

Link ID	ADV Router	Age	Seq#	Checksum
2.2.2.2	2.2.2.2	193	0x80000001	0x00FA31
3.3.3.3	2.2.2.2	103	0x80000001	0x004F98
23.23.23.0	2.2.2.2	193	0x80000001	0x00901F
33.33.33.5	2.2.2.2	103	0x80000001	0x00FE8C
33.33.33.6	2.2.2.2	103	0x80000001	0x00F495
33.33.33.7	2.2.2.2	103	0x80000001	0x00EA9E

```
33.33.33.8      2.2.2.2      103      0x80000001 0x00E0A7
```

#### Summary ASB Link States (Area 10)

Link ID	ADV Router	Age	Seq#	Checksum
3.3.3.3	2.2.2.2	105	0x80000001	0x0037B0

#### Type-5 AS External Link States

Link ID	ADV Router	Age	Seq#	Checksum	Tag
33.33.33.1	3.3.3.3	433	0x80000001	0x00DA55	0
33.33.33.2	3.3.3.3	433	0x80000001	0x00D05E	0
33.33.33.3	3.3.3.3	433	0x80000001	0x00C667	0
33.33.33.4	3.3.3.3	433	0x80000001	0x00BC70	0

```
R1(config-router)#
```

## OSPF Stub Area

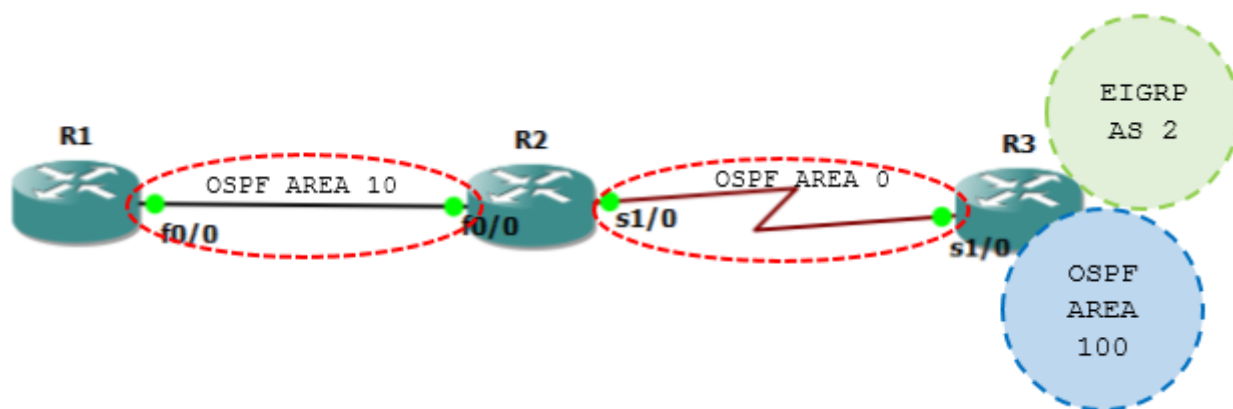

### Cek tabel routing R1.

```
R1#sh ip route
Gateway of last resort is not set

  1.0.0.0/32 is subnetted, 1 subnets
C       1.1.1.1 is directly connected, Loopback0
  2.0.0.0/32 is subnetted, 1 subnets
O IA   2.2.2.2 [110/11] via 12.12.12.2, 00:00:04, FastEthernet0/0
  33.0.0.0/32 is subnetted, 8 subnets
O E2   33.33.33.1 [110/20] via 12.12.12.2, 00:00:04, FastEthernet0/0
O E2   33.33.33.3 [110/20] via 12.12.12.2, 00:00:04, FastEthernet0/0
O E2   33.33.33.2 [110/20] via 12.12.12.2, 00:00:04, FastEthernet0/0
O IA   33.33.33.5 [110/75] via 12.12.12.2, 00:00:04, FastEthernet0/0
O E2   33.33.33.4 [110/20] via 12.12.12.2, 00:00:05, FastEthernet0/0
O IA   33.33.33.7 [110/75] via 12.12.12.2, 00:00:05, FastEthernet0/0
O IA   33.33.33.6 [110/75] via 12.12.12.2, 00:00:05, FastEthernet0/0
O IA   33.33.33.8 [110/75] via 12.12.12.2, 00:00:05, FastEthernet0/0
  3.0.0.0/32 is subnetted, 1 subnets
O IA   3.3.3.3 [110/75] via 12.12.12.2, 00:00:07, FastEthernet0/0
 23.0.0.0/24 is subnetted, 1 subnets
```



```
O IA 23.23.23.0 [110/74] via 12.12.12.2, 00:00:07, FastEthernet0/0
    12.0.0.0/24 is subnetted, 1 subnets
C    12.12.12.0 is directly connected, FastEthernet0/0
```

## Konfigurasi stub.

```
R1(config-router)#area 10 stub
R2(config-router)#area 10 stub
```

## Sekarang cek tabel routing lagi.

```
R1(config-router)#do sh ip route
Gateway of last resort is 12.12.12.2 to network 0.0.0.0

    1.0.0.0/32 is subnetted, 1 subnets
C    1.1.1.1 is directly connected, Loopback0
    2.0.0.0/32 is subnetted, 1 subnets
O IA 2.2.2.2 [110/11] via 12.12.12.2, 00:02:06, FastEthernet0/0
    33.0.0.0/32 is subnetted, 4 subnets
O IA 33.33.33.5 [110/75] via 12.12.12.2, 00:02:06, FastEthernet0/0
O IA 33.33.33.7 [110/75] via 12.12.12.2, 00:02:06, FastEthernet0/0
O IA 33.33.33.6 [110/75] via 12.12.12.2, 00:02:06, FastEthernet0/0
O IA 33.33.33.8 [110/75] via 12.12.12.2, 00:02:07, FastEthernet0/0
    3.0.0.0/32 is subnetted, 1 subnets
O IA 3.3.3.3 [110/75] via 12.12.12.2, 00:02:07, FastEthernet0/0
    23.0.0.0/24 is subnetted, 1 subnets
O IA 23.23.23.0 [110/74] via 12.12.12.2, 00:02:08, FastEthernet0/0
    12.0.0.0/24 is subnetted, 1 subnets
C    12.12.12.0 is directly connected, FastEthernet0/0
O*IA 0.0.0.0/0 [110/11] via 12.12.12.2, 00:02:09, FastEthernet0/0
```

## E2 hilang diganti dengan 0\*. Cek database OSPF.

```
R1#sh ip ospf database

    OSPF Router with ID (1.1.1.1) (Process ID 13)

    Router Link States (Area 10)

Link ID        ADV Router    Age           Seq#           Checksum Link count
1.1.1.1        1.1.1.1      339          0x80000005    0x00687D 2
2.2.2.2        2.2.2.2      499          0x80000005    0x0012B8 1

    Net Link States (Area 10)

Link ID        ADV Router    Age           Seq#           Checksum
12.12.12.2    2.2.2.2      495          0x80000003    0x002ED1

    Summary Net Link States (Area 10)

Link ID        ADV Router    Age           Seq#           Checksum
0.0.0.0        2.2.2.2      501          0x80000001    0x0075C0
2.2.2.2        2.2.2.2      501          0x80000002    0x001716
3.3.3.3        2.2.2.2      501          0x80000002    0x006B7D
23.23.23.0    2.2.2.2      501          0x80000002    0x00AC04
33.33.33.5    2.2.2.2      501          0x80000002    0x001B71
33.33.33.6    2.2.2.2      501          0x80000002    0x00117A
33.33.33.7    2.2.2.2      501          0x80000002    0x000783
33.33.33.8    2.2.2.2      503          0x80000002    0x00FC8C
```

## OSPF Totally Stub Area

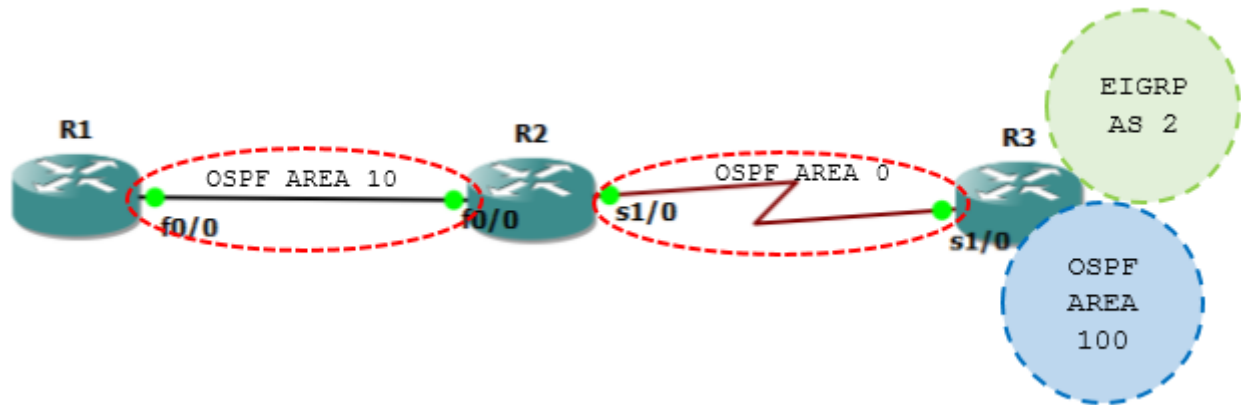

### Konfigurasi totally stub.

```
R2(config-router)#no area 10 stub
R2(config-router)#area 10 stub no-summary
```

### Cek tabel routing dan OSPF database.

```
R1#sh ip route
Gateway of last resort is 12.12.12.2 to network 0.0.0.0

 1.0.0.0/32 is subnetted, 1 subnets
 C       1.1.1.1 is directly connected, Loopback0
 12.0.0.0/24 is subnetted, 1 subnets
 C       12.12.12.0 is directly connected, FastEthernet0/0
 O*IA 0.0.0.0/0 [110/11] via 12.12.12.2, 00:00:47, FastEthernet0/0
```

```
R1#sh ip ospf database
```

```
OSPF Router with ID (1.1.1.1) (Process ID 13)
```

```
Router Link States (Area 10)
```

Link ID	ADV Router	Age	Seq#	Checksum	Link count
1.1.1.1	1.1.1.1	251	0x80000004	0x002F91	2
2.2.2.2	2.2.2.2	257	0x80000004	0x0014B7	1

```
Net Link States (Area 10)
```

Link ID	ADV Router	Age	Seq#	Checksum
12.12.12.2	2.2.2.2	252	0x80000003	0x002ED1

```
Summary Net Link States (Area 10)
```

Link ID	ADV Router	Age	Seq#	Checksum
0.0.0.0	2.2.2.2	625	0x80000001	0x0075C0

```
R1#
```

## OSPF Not So Stubby Area (NSSA)

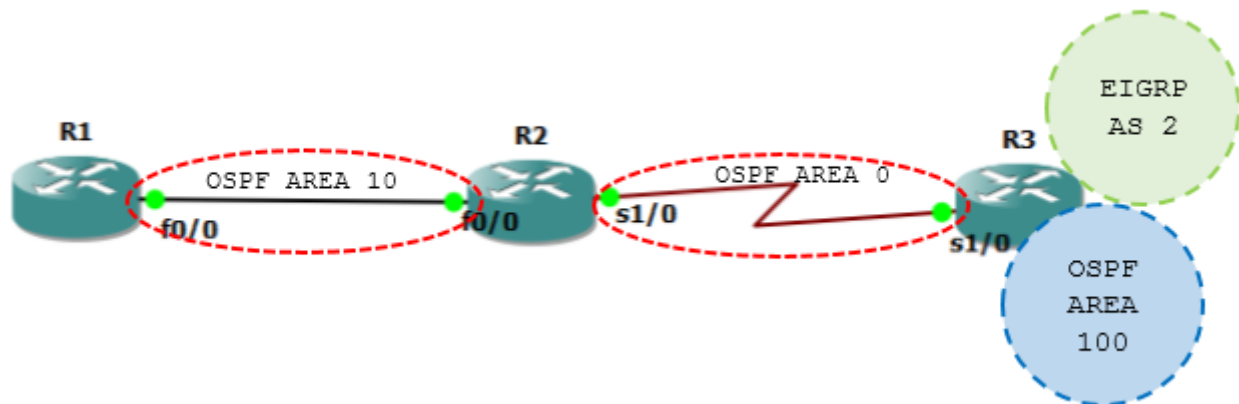

Tambahkan interface loopback di R1 dengan konfigurasi RIP.

```
R1(config-if)#interface Loopback1
R1(config-if)# ip address 11.11.11.1 255.255.255.255
R1(config-if)#interface Loopback2
R1(config-if)# ip address 11.11.11.2 255.255.255.255
R1(config-if)#interface Loopback3
R1(config-if)# ip address 11.11.11.3 255.255.255.255

R1(config-if)#router rip
R1(config-router)#ver 2
R1(config-router)#no auto-summary
R1(config-router)#net 11.0.0.0
R1(config)#router ospf 13
R1(config-router)#redistribute rip subnets
```

Hapus OSPF stub sebelumnya dan ganti dengan nssa.

```
R2(config-router)#no area 10 stub
R2(config-router)#area 10 nssa
*Mar  1 00:10:39.295: %OSPF-5-ADJCHG: Process 13, Nbr 2.2.2.2 on
FastEthernet0/0 from DOWN to DOWN, Neighbor Down: Adjacency forced to reset
```

Cek tabel routing R1. Internal area dari ospf area 100 muncul di stub router R1.

```
R1(config-router)#do sh ip route
Gateway of last resort is not set

    1.0.0.0/32 is subnetted, 1 subnets
C       1.1.1.1 is directly connected, Loopback0
    2.0.0.0/32 is subnetted, 1 subnets
O IA   2.2.2.2 [110/11] via 12.12.12.2, 00:01:48, FastEthernet0/0
    33.0.0.0/32 is subnetted, 4 subnets
O IA   33.33.33.5 [110/75] via 12.12.12.2, 00:01:48, FastEthernet0/0
O IA   33.33.33.7 [110/75] via 12.12.12.2, 00:01:48, FastEthernet0/0
O IA   33.33.33.6 [110/75] via 12.12.12.2, 00:01:48, FastEthernet0/0
O IA   33.33.33.8 [110/75] via 12.12.12.2, 00:01:48, FastEthernet0/0
    3.0.0.0/32 is subnetted, 1 subnets
O IA   3.3.3.3 [110/75] via 12.12.12.2, 00:01:49, FastEthernet0/0
    23.0.0.0/24 is subnetted, 1 subnets
O IA   23.23.23.0 [110/74] via 12.12.12.2, 00:01:49, FastEthernet0/0
```

```

    11.0.0.0/32 is subnetted, 3 subnets
C       11.11.11.3 is directly connected, Loopback3
C       11.11.11.2 is directly connected, Loopback2
C       11.11.11.1 is directly connected, Loopback1
    12.0.0.0/24 is subnetted, 1 subnets
C       12.12.12.0 is directly connected, FastEthernet0/0
R1(config-router)#

```

### Cek tabel routing R3. External route dari RIP dan EIGRP sudah muncul di R1.

```

R3#sh ip route
Gateway of last resort is not set

    1.0.0.0/32 is subnetted, 1 subnets
O IA   1.1.1.1 [110/75] via 23.23.23.2, 00:19:55, Serial1/0
    2.0.0.0/32 is subnetted, 1 subnets
O     2.2.2.2 [110/65] via 23.23.23.2, 00:27:47, Serial1/0
    33.0.0.0/32 is subnetted, 8 subnets
C     33.33.33.1 is directly connected, Loopback1
C     33.33.33.3 is directly connected, Loopback3
C     33.33.33.2 is directly connected, Loopback2
C     33.33.33.5 is directly connected, Loopback5
C     33.33.33.4 is directly connected, Loopback4
C     33.33.33.7 is directly connected, Loopback7
C     33.33.33.6 is directly connected, Loopback6
C     33.33.33.8 is directly connected, Loopback8
    3.0.0.0/32 is subnetted, 1 subnets
C     3.3.3.3 is directly connected, Loopback0
    23.0.0.0/24 is subnetted, 1 subnets
C     23.23.23.0 is directly connected, Serial1/0
    11.0.0.0/32 is subnetted, 3 subnets
O E2   11.11.11.3 [110/20] via 23.23.23.2, 00:19:11, Serial1/0
O E2   11.11.11.2 [110/20] via 23.23.23.2, 00:19:11, Serial1/0
O E2   11.11.11.1 [110/20] via 23.23.23.2, 00:19:11, Serial1/0
    12.0.0.0/24 is subnetted, 1 subnets
O IA   12.12.12.0 [110/74] via 23.23.23.2, 00:27:49, Serial1/0
R3#

```

Pada R1 belum ada default route sehingga belum bisa ping ke 33.33.33.1 - 33.33.33.4 pada network EIGRP pada R3 yang didistribute ke OSPF.

```

R1#ping 33.33.33.1

Type escape sequence to abort.
Sending 5, 100-byte ICMP Echos to 33.33.33.1, timeout is 2 seconds:
.....
Success rate is 0 percent (0/5)
R1#

```

Caranya adalah dengan menambahkan konfigurasi pada ABR routernya yaitu R2.

```

R2(config-router)#area 10 nssa default-information-originate

R1#sh ip route
Gateway of last resort is 12.12.12.2 to network 0.0.0.0

    1.0.0.0/32 is subnetted, 1 subnets
C     1.1.1.1 is directly connected, Loopback0

```

```

    2.0.0.0/32 is subnetted, 1 subnets
O IA    2.2.2.2 [110/11] via 12.12.12.2, 00:27:01, FastEthernet0/0
    33.0.0.0/32 is subnetted, 4 subnets
O IA    33.33.33.5 [110/75] via 12.12.12.2, 00:27:01, FastEthernet0/0
O IA    33.33.33.7 [110/75] via 12.12.12.2, 00:27:01, FastEthernet0/0
O IA    33.33.33.6 [110/75] via 12.12.12.2, 00:27:01, FastEthernet0/0
O IA    33.33.33.8 [110/75] via 12.12.12.2, 00:27:02, FastEthernet0/0
    3.0.0.0/32 is subnetted, 1 subnets
O IA    3.3.3.3 [110/75] via 12.12.12.2, 00:27:02, FastEthernet0/0
    23.0.0.0/24 is subnetted, 1 subnets
O IA    23.23.23.0 [110/74] via 12.12.12.2, 00:27:03, FastEthernet0/0
    11.0.0.0/32 is subnetted, 3 subnets
C       11.11.11.3 is directly connected, Loopback3
C       11.11.11.2 is directly connected, Loopback2
C       11.11.11.1 is directly connected, Loopback1
    12.0.0.0/24 is subnetted, 1 subnets
C       12.12.12.0 is directly connected, FastEthernet0/0
O*N2 0.0.0.0/0 [110/1] via 12.12.12.2, 00:00:18, FastEthernet0/0
R1#ping 33.33.33.1

Type escape sequence to abort.
Sending 5, 100-byte ICMP Echos to 33.33.33.1, timeout is 2 seconds:
!!!!
Success rate is 100 percent (5/5), round-trip min/avg/max = 20/64/124 ms
R1#

```

**Jika diinginkan internal route OSPF area lain tidak ditampilkan dalam database namun masih bisa mengirimkan External Route RIP nya, maka tambahkan no-summary pada ABR R2.**

```

R2(config-router)#area 10 nssa no-summary

Cek tabel route R1.
R1#sh ip route
Gateway of last resort is 12.12.12.2 to network 0.0.0.0

    1.0.0.0/32 is subnetted, 1 subnets
C       1.1.1.1 is directly connected, Loopback0
    11.0.0.0/32 is subnetted, 3 subnets
C       11.11.11.3 is directly connected, Loopback3
C       11.11.11.2 is directly connected, Loopback2
C       11.11.11.1 is directly connected, Loopback1
    12.0.0.0/24 is subnetted, 1 subnets
C       12.12.12.0 is directly connected, FastEthernet0/0
O*IA 0.0.0.0/0 [110/11] via 12.12.12.2, 00:00:17, FastEthernet0/0
R1#ping 33.33.33.1

Type escape sequence to abort.
Sending 5, 100-byte ICMP Echos to 33.33.33.1, timeout is 2 seconds:
!!!!
Success rate is 100 percent (5/5), round-trip min/avg/max = 24/80/144 ms

```

**Pastikan external route RIP dari R1 masih bisa diterima R3.**

```

R3#sh ip route
Gateway of last resort is not set

    1.0.0.0/32 is subnetted, 1 subnets

```

```

O IA 1.1.1.1 [110/75] via 23.23.23.2, 00:32:10, Serial1/0
    2.0.0.0/32 is subnetted, 1 subnets
O    2.2.2.2 [110/65] via 23.23.23.2, 00:40:02, Serial1/0
    33.0.0.0/32 is subnetted, 8 subnets
C    33.33.33.1 is directly connected, Loopback1
C    33.33.33.3 is directly connected, Loopback3
C    33.33.33.2 is directly connected, Loopback2
C    33.33.33.5 is directly connected, Loopback5
C    33.33.33.4 is directly connected, Loopback4
C    33.33.33.7 is directly connected, Loopback7
C    33.33.33.6 is directly connected, Loopback6
C    33.33.33.8 is directly connected, Loopback8
    3.0.0.0/32 is subnetted, 1 subnets
C    3.3.3.3 is directly connected, Loopback0
    23.0.0.0/24 is subnetted, 1 subnets
C    23.23.23.0 is directly connected, Serial1/0
    11.0.0.0/32 is subnetted, 3 subnets
O E2 11.11.11.3 [110/20] via 23.23.23.2, 00:31:28, Serial1/0
O E2 11.11.11.2 [110/20] via 23.23.23.2, 00:31:28, Serial1/0
O E2 11.11.11.1 [110/20] via 23.23.23.2, 00:31:28, Serial1/0
    12.0.0.0/24 is subnetted, 1 subnets
O IA 12.12.12.0 [110/74] via 23.23.23.2, 00:40:06, Serial1/0
R3#ping 11.11.11.1

```

```

Type escape sequence to abort.
Sending 5, 100-byte ICMP Echos to 11.11.11.1, timeout is 2 seconds:
!!!!
Success rate is 100 percent (5/5), round-trip min/avg/max = 20/65/104 ms
R3#

```

## OSPF External Route Type 1

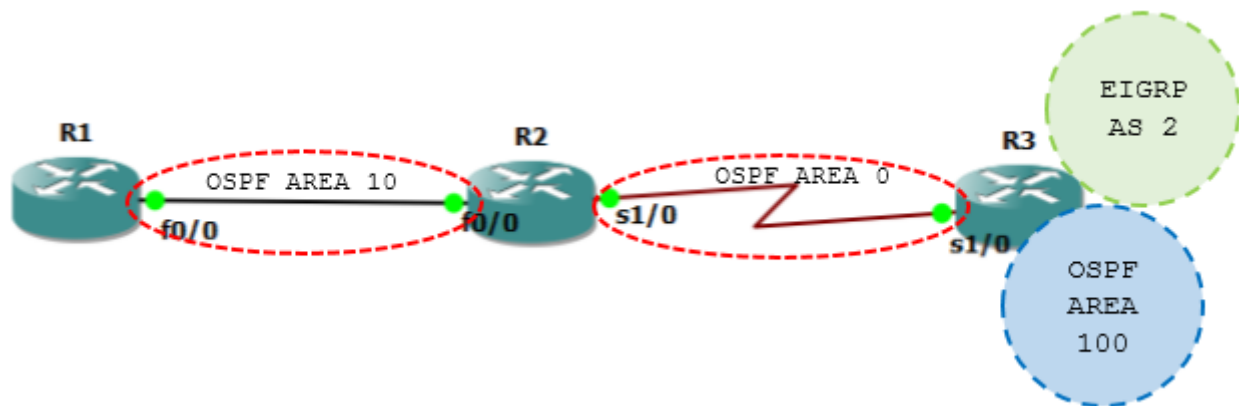

```

R2#sh ip route
Gateway of last resort is not set

    1.0.0.0/32 is subnetted, 1 subnets
O    1.1.1.1 [110/11] via 12.12.12.1, 00:02:05, FastEthernet0/0
    2.0.0.0/32 is subnetted, 1 subnets
C    2.2.2.2 is directly connected, Loopback0

```

```

33.0.0.0/32 is subnetted, 8 subnets
O E2   33.33.33.1 [110/20] via 23.23.23.3, 00:02:41, Serial1/0
O E2   33.33.33.3 [110/20] via 23.23.23.3, 00:02:41, Serial1/0
O E2   33.33.33.2 [110/20] via 23.23.23.3, 00:02:41, Serial1/0
O IA   33.33.33.5 [110/65] via 23.23.23.3, 00:02:41, Serial1/0
O E2   33.33.33.4 [110/20] via 23.23.23.3, 00:02:42, Serial1/0
O IA   33.33.33.7 [110/65] via 23.23.23.3, 00:02:42, Serial1/0
O IA   33.33.33.6 [110/65] via 23.23.23.3, 00:02:42, Serial1/0
O IA   33.33.33.8 [110/65] via 23.23.23.3, 00:02:42, Serial1/0
3.0.0.0/32 is subnetted, 1 subnets
O      3.3.3.3 [110/65] via 23.23.23.3, 00:02:43, Serial1/0
23.0.0.0/24 is subnetted, 1 subnets
C      23.23.23.0 is directly connected, Serial1/0
11.0.0.0/32 is subnetted, 3 subnets
O N2   11.11.11.3 [110/20] via 12.12.12.1, 00:02:08, FastEthernet0/0
O N2   11.11.11.2 [110/20] via 12.12.12.1, 00:02:08, FastEthernet0/0
O N2   11.11.11.1 [110/20] via 12.12.12.1, 00:02:08, FastEthernet0/0
12.0.0.0/24 is subnetted, 1 subnets
C      12.12.12.0 is directly connected, FastEthernet0/0
R2#

```

R3#sh ip route

Gateway of last resort is not set

```

1.0.0.0/32 is subnetted, 1 subnets
O IA   1.1.1.1 [110/75] via 23.23.23.2, 00:01:14, Serial1/0
2.0.0.0/32 is subnetted, 1 subnets
O      2.2.2.2 [110/65] via 23.23.23.2, 00:01:47, Serial1/0
33.0.0.0/32 is subnetted, 8 subnets
C      33.33.33.1 is directly connected, Loopback1
C      33.33.33.3 is directly connected, Loopback3
C      33.33.33.2 is directly connected, Loopback2
C      33.33.33.5 is directly connected, Loopback5
C      33.33.33.4 is directly connected, Loopback4
C      33.33.33.7 is directly connected, Loopback7
C      33.33.33.6 is directly connected, Loopback6
C      33.33.33.8 is directly connected, Loopback8
3.0.0.0/32 is subnetted, 1 subnets
C      3.3.3.3 is directly connected, Loopback0
23.0.0.0/24 is subnetted, 1 subnets
C      23.23.23.0 is directly connected, Serial1/0
11.0.0.0/32 is subnetted, 3 subnets
O E2   11.11.11.3 [110/20] via 23.23.23.2, 00:01:11, Serial1/0
O E2   11.11.11.2 [110/20] via 23.23.23.2, 00:01:11, Serial1/0
O E2   11.11.11.1 [110/20] via 23.23.23.2, 00:01:11, Serial1/0
12.0.0.0/24 is subnetted, 1 subnets
O IA   12.12.12.0 [110/74] via 23.23.23.2, 00:01:49, Serial1/0

```

R3#sh ip route 11.11.11.1

Routing entry for 11.11.11.1/32

Known via "ospf 14", distance 110, metric 20, type extern 2, forward metric 75

Last update from 23.23.23.2 on Serial1/0, 00:02:39 ago

Routing Descriptor Blocks:

\* 23.23.23.2, from 2.2.2.2, 00:02:39 ago, via Serial1/0

Route metric is 20, traffic share count is 1

## Konfigurasi external route 1.

```
R1(config)#route-map TIPE_SATU
R1(config-route-map)#set metric-type type-1
R1(config-route-map)#router ospf 13
R1(config-router)#redistribute rip subnets route-map TIPE_SATU
```

## Cek di R3.

```
R3#sh ip route
Gateway of last resort is not set

    1.0.0.0/32 is subnetted, 1 subnets
O IA   1.1.1.1 [110/75] via 23.23.23.2, 00:01:01, Serial1/0
    2.0.0.0/32 is subnetted, 1 subnets
O     2.2.2.2 [110/65] via 23.23.23.2, 00:01:01, Serial1/0
    33.0.0.0/32 is subnetted, 8 subnets
C     33.33.33.1 is directly connected, Loopback1
C     33.33.33.3 is directly connected, Loopback3
C     33.33.33.2 is directly connected, Loopback2
C     33.33.33.5 is directly connected, Loopback5
C     33.33.33.4 is directly connected, Loopback4
C     33.33.33.7 is directly connected, Loopback7
C     33.33.33.6 is directly connected, Loopback6
C     33.33.33.8 is directly connected, Loopback8
    3.0.0.0/32 is subnetted, 1 subnets
C     3.3.3.3 is directly connected, Loopback0
    23.0.0.0/24 is subnetted, 1 subnets
C     23.23.23.0 is directly connected, Serial1/0
    11.0.0.0/32 is subnetted, 3 subnets
O E1   11.11.11.3 [110/95] via 23.23.23.2, 00:00:53, Serial1/0
O E1   11.11.11.2 [110/95] via 23.23.23.2, 00:00:53, Serial1/0
O E1   11.11.11.1 [110/95] via 23.23.23.2, 00:00:53, Serial1/0
    12.0.0.0/24 is subnetted, 1 subnets
O IA   12.12.12.0 [110/74] via 23.23.23.2, 00:01:03, Serial1/0
R3#
```

```
R2#sh ip route
Gateway of last resort is not set

    1.0.0.0/32 is subnetted, 1 subnets
O     1.1.1.1 [110/11] via 12.12.12.1, 00:02:42, FastEthernet0/0
    2.0.0.0/32 is subnetted, 1 subnets
C     2.2.2.2 is directly connected, Loopback0
    33.0.0.0/32 is subnetted, 8 subnets
O E2   33.33.33.1 [110/20] via 23.23.23.3, 00:02:42, Serial1/0
O E2   33.33.33.3 [110/20] via 23.23.23.3, 00:02:42, Serial1/0
O E2   33.33.33.2 [110/20] via 23.23.23.3, 00:02:42, Serial1/0
O IA   33.33.33.5 [110/65] via 23.23.23.3, 00:02:42, Serial1/0
O E2   33.33.33.4 [110/20] via 23.23.23.3, 00:02:44, Serial1/0
O IA   33.33.33.7 [110/65] via 23.23.23.3, 00:02:44, Serial1/0
O IA   33.33.33.6 [110/65] via 23.23.23.3, 00:02:44, Serial1/0
O IA   33.33.33.8 [110/65] via 23.23.23.3, 00:02:44, Serial1/0
    3.0.0.0/32 is subnetted, 1 subnets
O     3.3.3.3 [110/65] via 23.23.23.3, 00:02:46, Serial1/0
    23.0.0.0/24 is subnetted, 1 subnets
C     23.23.23.0 is directly connected, Serial1/0
    11.0.0.0/32 is subnetted, 3 subnets
```



```

O N1 11.11.11.3 [110/31] via 12.12.12.1, 00:02:46, FastEthernet0/0
O N1 11.11.11.2 [110/31] via 12.12.12.1, 00:02:46, FastEthernet0/0
O N1 11.11.11.1 [110/31] via 12.12.12.1, 00:02:46, FastEthernet0/0
12.0.0.0/24 is subnetted, 1 subnets
C 12.12.12.0 is directly connected, FastEthernet0/0
R2#

```

Jika sebelumnya metric sama-sama 20 pada tabel routing R2 dan R3, sekarang sudah berbeda.

## OSPF Filtering Using Distribute List

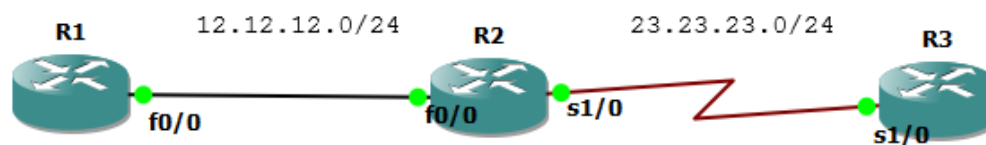

```

R1
interface Loopback0
 ip address 1.1.1.1 255.255.255.255
 !
interface FastEthernet0/0
 ip address 12.12.12.1 255.255.255.0
 !
router ospf 1
 router-id 1.1.1.1
 network 0.0.0.0 255.255.255.255 area 0
 !

R2
interface Loopback0
 ip address 2.2.2.2 255.255.255.255
 !
interface FastEthernet0/0
 ip address 12.12.12.2 255.255.255.0
 !
interface Serial1/0
 ip address 23.23.23.2 255.255.255.0
 !
router ospf 2
 router-id 2.2.2.2
 network 0.0.0.0 255.255.255.255 area 0
 !

R3
interface Loopback0
 ip address 3.3.3.3 255.255.255.255
 !
interface Serial1/0
 ip address 23.23.23.3 255.255.255.0
 !

```

```
router ospf 3
  router-id 3.3.3.3
  network 0.0.0.0 255.255.255.255 area 0
!
```

Buat ip loopback yang bervariasi.

```
R1(config)#int lo1
R1(config-if)#ip add 11.11.11.1 255.255.255.255
R1(config-if)#int lo2
R1(config-if)#ip add 11.11.11.2 255.255.255.255
R1(config-if)#int lo3
R1(config-if)#ip add 11.11.11.3 255.255.255.255
R1(config-if)#int lo4
R1(config-if)#ip add 11.11.11.4 255.255.255.255
R1(config-if)#int lo5
R1(config-if)#ip add 11.11.11.5 255.255.255.255
R1(config-if)#int lo6
R1(config-if)#ip add 11.11.11.6 255.255.255.255
```

## Cek routing table.

```
R2#sh ip route
Gateway of last resort is not set

    1.0.0.0/32 is subnetted, 1 subnets
O       1.1.1.1 [110/11] via 12.12.12.1, 00:05:05, FastEthernet0/0
    2.0.0.0/32 is subnetted, 1 subnets
C       2.2.2.2 is directly connected, Loopback0
    3.0.0.0/32 is subnetted, 1 subnets
O       3.3.3.3 [110/65] via 23.23.23.3, 00:04:12, Serial1/0
    23.0.0.0/24 is subnetted, 1 subnets
C       23.23.23.0 is directly connected, Serial1/0
    11.0.0.0/32 is subnetted, 6 subnets
O       11.11.11.3 [110/11] via 12.12.12.1, 00:00:47, FastEthernet0/0
O       11.11.11.2 [110/11] via 12.12.12.1, 00:00:49, FastEthernet0/0
O       11.11.11.1 [110/11] via 12.12.12.1, 00:00:49, FastEthernet0/0
O       11.11.11.6 [110/11] via 12.12.12.1, 00:00:49, FastEthernet0/0
O       11.11.11.5 [110/11] via 12.12.12.1, 00:00:49, FastEthernet0/0
O       11.11.11.4 [110/11] via 12.12.12.1, 00:00:49, FastEthernet0/0
    12.0.0.0/24 is subnetted, 1 subnets
C       12.12.12.0 is directly connected, FastEthernet0/0
R2#
```

## Filter yang ganjil saja menggunakan access-list dan konfigurasi distribute-list.

```
R2(config)#access-list 10 permit 0.0.0.1 255.255.255.254
R2(config)#router ospf 2
R2(config-router)#distribute-list 10 in
```

## Cek tabel routing dan lihat hasilnya.

```
R2(config-router)#do sh ip route
Codes: C - connected, S - static, R - RIP, M - mobile, B - BGP
       D - EIGRP, EX - EIGRP external, O - OSPF, IA - OSPF inter area
       N1 - OSPF NSSA external type 1, N2 - OSPF NSSA external type 2
       E1 - OSPF external type 1, E2 - OSPF external type 2
       i - IS-IS, su - IS-IS summary, L1 - IS-IS level-1, L2 - IS-IS level-2
       ia - IS-IS inter area, * - candidate default, U - per-user static
route
```

o - ODR, P - periodic downloaded static route

Gateway of last resort is not set

```
1.0.0.0/32 is subnetted, 1 subnets
O   1.1.1.1 [110/11] via 12.12.12.1, 00:00:15, FastEthernet0/0
2.0.0.0/32 is subnetted, 1 subnets
C   2.2.2.2 is directly connected, Loopback0
3.0.0.0/32 is subnetted, 1 subnets
O   3.3.3.3 [110/65] via 23.23.23.3, 00:00:15, Serial1/0
23.0.0.0/24 is subnetted, 1 subnets
C   23.23.23.0 is directly connected, Serial1/0
11.0.0.0/32 is subnetted, 3 subnets
O   11.11.11.3 [110/11] via 12.12.12.1, 00:00:15, FastEthernet0/0
O   11.11.11.1 [110/11] via 12.12.12.1, 00:00:16, FastEthernet0/0
O   11.11.11.5 [110/11] via 12.12.12.1, 00:00:16, FastEthernet0/0
12.0.0.0/24 is subnetted, 1 subnets
C   12.12.12.0 is directly connected, FastEthernet0/0
R2(config-router)#
```

Walau didalam ip route tidak muncul, namun di ospf database masih muncul karena router dalam area yang sama memiliki database yang sama.

R2#sh ip ospf database

OSPF Router with ID (2.2.2.2) (Process ID 2)

Router Link States (Area 0)

Link ID	ADV Router	Age	Seq#	Checksum	Link count
1.1.1.1	1.1.1.1	401	0x80000007	0x003446	8
2.2.2.2	2.2.2.2	617	0x80000002	0x000875	4
3.3.3.3	3.3.3.3	613	0x80000002	0x007365	3

Net Link States (Area 0)

Link ID	ADV Router	Age	Seq#	Checksum
12.12.12.1	1.1.1.1	662	0x80000001	0x004CB8

R2#

R1#sh ip ospf database

OSPF Router with ID (1.1.1.1) (Process ID 1)

Router Link States (Area 0)

Link ID	ADV Router	Age	Seq#	Checksum	Link count
1.1.1.1	1.1.1.1	430	0x80000007	0x003446	8
2.2.2.2	2.2.2.2	648	0x80000002	0x000875	4
3.3.3.3	3.3.3.3	643	0x80000002	0x007365	3

Net Link States (Area 0)

Link ID	ADV Router	Age	Seq#	Checksum
12.12.12.1	1.1.1.1	690	0x80000001	0x004CB8

R1#

## OSPF Summarization – Area Range

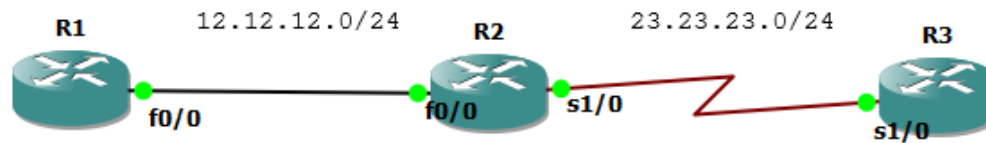

```
R1
interface Loopback0
 ip address 1.1.1.1 255.255.255.255
!
interface FastEthernet0/0
 ip address 12.12.12.1 255.255.255.0
!
router ospf 1
 router-id 1.1.1.1
 network 0.0.0.0 255.255.255.255 area 0
!

R2
interface Loopback0
 ip address 2.2.2.2 255.255.255.255
!
interface FastEthernet0/0
 ip address 12.12.12.2 255.255.255.0
!
interface Serial1/0
 ip address 23.23.23.2 255.255.255.0
!
router ospf 2
 router-id 2.2.2.2
 network 0.0.0.0 255.255.255.255 area 0
!

R3
interface Loopback0
 ip address 3.3.3.3 255.255.255.255
!
interface Serial1/0
 ip address 23.23.23.3 255.255.255.0
!
router ospf 3
 router-id 3.3.3.3
 network 0.0.0.0 255.255.255.255 area 0
!
```

**Buat ip loopback untuk nantinya disummary.**

```
R3(config)#int lo1
R3(config-if)#ip add 33.33.33.1 255.255.255.255
R3(config-if)#int lo2
R3(config-if)#ip add 33.33.33.2 255.255.255.255
R3(config-if)#int lo3
R3(config-if)#ip add 33.33.33.3 255.255.255.255
R3(config-if)#int lo4
```

```

R3(config-if)#ip add 33.33.33.4 255.255.255.255
R3(config-if)#int lo5
R3(config-if)#ip add 33.33.33.5 255.255.255.255
R3(config-if)#int lo6
R3(config-if)#ip add 33.33.33.6 255.255.255.255

R3(config)#router ospf 3
R3(config-router)#net 33.33.33.1 0.0.0.0 area 10
R3(config-router)#net 33.33.33.2 0.0.0.0 area 10
R3(config-router)#net 33.33.33.3 0.0.0.0 area 10
R3(config-router)#net 33.33.33.4 0.0.0.0 area 10
R3(config-router)#net 33.33.33.5 0.0.0.0 area 10
R3(config-router)#net 33.33.33.6 0.0.0.0 area 10

R1(config-router)#do sh ip route
Codes: C - connected, S - static, R - RIP, M - mobile, B - BGP
       D - EIGRP, EX - EIGRP external, O - OSPF, IA - OSPF inter area
       N1 - OSPF NSSA external type 1, N2 - OSPF NSSA external type 2
       E1 - OSPF external type 1, E2 - OSPF external type 2
       i - IS-IS, su - IS-IS summary, L1 - IS-IS level-1, L2 - IS-IS level-2
       ia - IS-IS inter area, * - candidate default, U - per-user static
route
       o - ODR, P - periodic downloaded static route

Gateway of last resort is not set

    1.0.0.0/32 is subnetted, 1 subnets
C       1.1.1.1 is directly connected, Loopback0
    2.0.0.0/32 is subnetted, 1 subnets
O       2.2.2.2 [110/11] via 12.12.12.2, 00:04:12, FastEthernet0/0
    33.0.0.0/32 is subnetted, 6 subnets
O IA    33.33.33.1 [110/75] via 12.12.12.2, 00:00:20, FastEthernet0/0
O IA    33.33.33.3 [110/75] via 12.12.12.2, 00:00:20, FastEthernet0/0
O IA    33.33.33.2 [110/75] via 12.12.12.2, 00:00:20, FastEthernet0/0
O IA    33.33.33.5 [110/75] via 12.12.12.2, 00:00:20, FastEthernet0/0
O IA    33.33.33.4 [110/75] via 12.12.12.2, 00:00:21, FastEthernet0/0
O IA    33.33.33.6 [110/75] via 12.12.12.2, 00:00:12, FastEthernet0/0
    3.0.0.0/32 is subnetted, 1 subnets
O       3.3.3.3 [110/75] via 12.12.12.2, 00:02:51, FastEthernet0/0
    23.0.0.0/24 is subnetted, 1 subnets
O       23.23.23.0 [110/74] via 12.12.12.2, 00:04:15, FastEthernet0/0
    12.0.0.0/24 is subnetted, 1 subnets
C       12.12.12.0 is directly connected, FastEthernet0/0
R1(config-router)#

```

### Konfigurasi summary di R3.

```

R3(config-router)#area 10 range 33.33.33.0 255.255.255.248
Cek tabel routing dan sudah tersummary.
R1(config-router)#do sh ip route
Gateway of last resort is not set

    1.0.0.0/32 is subnetted, 1 subnets
C       1.1.1.1 is directly connected, Loopback0
    2.0.0.0/32 is subnetted, 1 subnets
O       2.2.2.2 [110/11] via 12.12.12.2, 00:05:34, FastEthernet0/0
    33.0.0.0/29 is subnetted, 1 subnets

```

```

O IA 33.33.33.0 [110/75] via 12.12.12.2, 00:00:06, FastEthernet0/0
    3.0.0.0/32 is subnetted, 1 subnets
O    3.3.3.3 [110/75] via 12.12.12.2, 00:04:12, FastEthernet0/0
    23.0.0.0/24 is subnetted, 1 subnets
O    23.23.23.0 [110/74] via 12.12.12.2, 00:05:36, FastEthernet0/0
    12.0.0.0/24 is subnetted, 1 subnets
C    12.12.12.0 is directly connected, FastEthernet0/0
R1(config-router)#
Gateway of last resort is not set

    1.0.0.0/32 is subnetted, 1 subnets
O    1.1.1.1 [110/75] via 23.23.23.2, 00:02:04, Serial1/0
    2.0.0.0/32 is subnetted, 1 subnets
O    2.2.2.2 [110/65] via 23.23.23.2, 00:02:04, Serial1/0
    33.0.0.0/8 is variably subnetted, 7 subnets, 2 masks
C    33.33.33.1/32 is directly connected, Loopback1
O    33.33.33.0/29 is a summary, 00:02:04, Null0
C    33.33.33.3/32 is directly connected, Loopback3
C    33.33.33.2/32 is directly connected, Loopback2
C    33.33.33.5/32 is directly connected, Loopback5
C    33.33.33.4/32 is directly connected, Loopback4
C    33.33.33.6/32 is directly connected, Loopback6
    3.0.0.0/32 is subnetted, 1 subnets
C    3.3.3.3 is directly connected, Loopback0
    23.0.0.0/24 is subnetted, 1 subnets
C    23.23.23.0 is directly connected, Serial1/0
    12.0.0.0/24 is subnetted, 1 subnets
O    12.12.12.0 [110/74] via 23.23.23.2, 00:02:06, Serial1/0
R3#

```

**Jika ingin menghapus Null0 gunakan perintah dibawah.**

```

R3(config-router)#no discard-route internal
R3(config-router)#do sh ip route
Gateway of last resort is not set

    1.0.0.0/32 is subnetted, 1 subnets
O    1.1.1.1 [110/75] via 23.23.23.2, 00:00:09, Serial1/0
    2.0.0.0/32 is subnetted, 1 subnets
O    2.2.2.2 [110/65] via 23.23.23.2, 00:00:09, Serial1/0
    33.0.0.0/32 is subnetted, 6 subnets
C    33.33.33.1 is directly connected, Loopback1
C    33.33.33.3 is directly connected, Loopback3
C    33.33.33.2 is directly connected, Loopback2
C    33.33.33.5 is directly connected, Loopback5
C    33.33.33.4 is directly connected, Loopback4
C    33.33.33.6 is directly connected, Loopback6
    3.0.0.0/32 is subnetted, 1 subnets
C    3.3.3.3 is directly connected, Loopback0
    23.0.0.0/24 is subnetted, 1 subnets
C    23.23.23.0 is directly connected, Serial1/0
    12.0.0.0/24 is subnetted, 1 subnets
O    12.12.12.0 [110/74] via 23.23.23.2, 00:00:11, Serial1/0
R3(config-router)#

```

**Dan Null0 sudah tiada.**

## OSPF Summarization – Summary Address

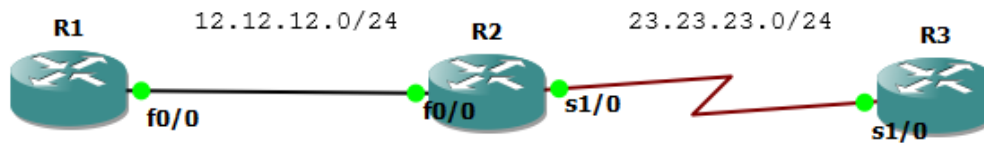

Masih menggunakan lab sebelumnya.

```
R3(config)#router eigrp 3
R3(config-router)#net 33.33.33.1 0.0.0.0
R3(config-router)#net 33.33.33.2 0.0.0.0
R3(config-router)#net 33.33.33.3 0.0.0.0
R3(config-router)#net 33.33.33.4 0.0.0.0
R3(config-router)#net 33.33.33.5 0.0.0.0
R3(config-router)#net 33.33.33.6 0.0.0.0
R3(config-router)#no auto-summary
```

```
R3(config)#no router ospf 3
*Mar 1 00:01:06.811: %OSPF-5-ADJCHG: Process 3, Nbr 2.2.2.2 on Serial1/0
from FULL to DOWN, Neighbor Down: Interface down or detached
R3(config)#router ospf 3
R3(config-router)#router-id 3.3.3.3
R3(config-router)#network 3.3.3.3 0.0.0.0 area 0
R3(config-router)#network 23.23.23.3 0.0.0.0 area 0 e
R3(config-router)#redistribute eigrp 3 subnets
```

```
R1#sh ip route
```

```
Gateway of last resort is not set
```

```

  1.0.0.0/32 is subnetted, 1 subnets
C       1.1.1.1 is directly connected, Loopback0
  2.0.0.0/32 is subnetted, 1 subnets
O       2.2.2.2 [110/11] via 12.12.12.2, 00:04:26, FastEthernet0/0
 33.0.0.0/32 is subnetted, 6 subnets
O E2    33.33.33.1 [110/20] via 12.12.12.2, 00:01:08, FastEthernet0/0
O E2    33.33.33.3 [110/20] via 12.12.12.2, 00:01:08, FastEthernet0/0
O E2    33.33.33.2 [110/20] via 12.12.12.2, 00:01:08, FastEthernet0/0
O E2    33.33.33.5 [110/20] via 12.12.12.2, 00:01:08, FastEthernet0/0
O E2    33.33.33.4 [110/20] via 12.12.12.2, 00:01:09, FastEthernet0/0
O E2    33.33.33.6 [110/20] via 12.12.12.2, 00:01:09, FastEthernet0/0
  3.0.0.0/32 is subnetted, 1 subnets
O       3.3.3.3 [110/75] via 12.12.12.2, 00:03:15, FastEthernet0/0
 23.0.0.0/24 is subnetted, 1 subnets
O       23.23.23.0 [110/74] via 12.12.12.2, 00:04:36, FastEthernet0/0
 12.0.0.0/24 is subnetted, 1 subnets
C       12.12.12.0 is directly connected, FastEthernet0/0
R1#
```

Konfigurasi external route summary di R3.

```
R3(config-router)#summary-address 33.33.33.0 255.255.255.248
```

Cek lagi tabel routing R1.

```
R1#sh ip route
```

```
Gateway of last resort is not set
```

```
1.0.0.0/32 is subnetted, 1 subnets
C    1.1.1.1 is directly connected, Loopback0
2.0.0.0/32 is subnetted, 1 subnets
O    2.2.2.2 [110/11] via 12.12.12.2, 00:06:38, FastEthernet0/0
33.0.0.0/29 is subnetted, 1 subnets
O E2  33.33.33.0 [110/20] via 12.12.12.2, 00:00:30, FastEthernet0/0
3.0.0.0/32 is subnetted, 1 subnets
O    3.3.3.3 [110/75] via 12.12.12.2, 00:05:25, FastEthernet0/0
23.0.0.0/24 is subnetted, 1 subnets
O    23.23.23.0 [110/74] via 12.12.12.2, 00:06:39, FastEthernet0/0
12.0.0.0/24 is subnetted, 1 subnets
C    12.12.12.0 is directly connected, FastEthernet0/0
R1#
```

## OSPF Default Route

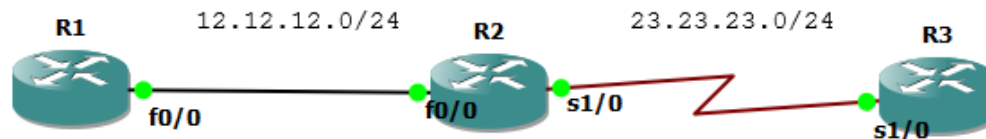

Masih menggunakan lab sebelumnya. Buat 1 ip loopback di R3 dan tidak usah diadvertise.

```
R3(config)#int lo11
R3(config-if)#ip add 113.113.113.113 255.255.255.255
```

Untuk mengakses loopback 113.113.113.113 yang tidak diadvertise, maka gunakan default route.

```
R3(config)#router ospf 3
R3(config-router)#default-information originate always
```

Cek tabel routing R1.

```
R1#sh ip route
Codes: C - connected, S - static, R - RIP, M - mobile, B - BGP
       D - EIGRP, EX - EIGRP external, O - OSPF, IA - OSPF inter area
       N1 - OSPF NSSA external type 1, N2 - OSPF NSSA external type 2
       E1 - OSPF external type 1, E2 - OSPF external type 2
       i - IS-IS, su - IS-IS summary, L1 - IS-IS level-1, L2 - IS-IS level-2
       ia - IS-IS inter area, * - candidate default, U - per-user static
route
       o - ODR, P - periodic downloaded static route

Gateway of last resort is 12.12.12.2 to network 0.0.0.0
```



```

    1.0.0.0/32 is subnetted, 1 subnets
C       1.1.1.1 is directly connected, Loopback0
    2.0.0.0/32 is subnetted, 1 subnets
O       2.2.2.2 [110/11] via 12.12.12.2, 00:02:49, FastEthernet0/0
    33.0.0.0/29 is subnetted, 1 subnets
O E2    33.33.33.0 [110/20] via 12.12.12.2, 00:02:49, FastEthernet0/0
    3.0.0.0/32 is subnetted, 1 subnets
O       3.3.3.3 [110/75] via 12.12.12.2, 00:02:49, FastEthernet0/0
    23.0.0.0/24 is subnetted, 1 subnets
O       23.23.23.0 [110/74] via 12.12.12.2, 00:02:51, FastEthernet0/0
    12.0.0.0/24 is subnetted, 1 subnets
C       12.12.12.0 is directly connected, FastEthernet0/0
O*E2 0.0.0.0/0 [110/1] via 12.12.12.2, 00:00:09, FastEthernet0/0
R1#ping 113.113.113.113

R1#sh ip route
Codes: C - connected, S - static, R - RIP, M - mobile, B - BGP
       D - EIGRP, EX - EIGRP external, O - OSPF, IA - OSPF inter area
       N1 - OSPF NSSA external type 1, N2 - OSPF NSSA external type 2
       E1 - OSPF external type 1, E2 - OSPF external type 2
       i - IS-IS, su - IS-IS summary, L1 - IS-IS level-1, L2 - IS-IS level-2
       ia - IS-IS inter area, * - candidate default, U - per-user static
route
       o - ODR, P - periodic downloaded static route

Gateway of last resort is 12.12.12.2 to network 0.0.0.0

    1.0.0.0/32 is subnetted, 1 subnets
C       1.1.1.1 is directly connected, Loopback0
    2.0.0.0/32 is subnetted, 1 subnets
O       2.2.2.2 [110/11] via 12.12.12.2, 00:02:49, FastEthernet0/0
    33.0.0.0/29 is subnetted, 1 subnets
O E2    33.33.33.0 [110/20] via 12.12.12.2, 00:02:49, FastEthernet0/0
    3.0.0.0/32 is subnetted, 1 subnets
O       3.3.3.3 [110/75] via 12.12.12.2, 00:02:49, FastEthernet0/0
    23.0.0.0/24 is subnetted, 1 subnets
O       23.23.23.0 [110/74] via 12.12.12.2, 00:02:51, FastEthernet0/0
    12.0.0.0/24 is subnetted, 1 subnets
C       12.12.12.0 is directly connected, FastEthernet0/0
O*E2 0.0.0.0/0 [110/1] via 12.12.12.2, 00:00:09, FastEthernet0/0
R1#ping 113.113.113.113

Type escape sequence to abort.
Sending 5, 100-byte ICMP Echos to 113.113.113.113, timeout is 2 seconds:
!!!!
Success rate is 100 percent (5/5), round-trip min/avg/max = 16/164/280 ms
R1#

Type escape sequence to abort.
Sending 5, 100-byte ICMP Echos to 113.113.113.113, timeout is 2 seconds:
!!!!
Success rate is 100 percent (5/5), round-trip min/avg/max = 16/164/280 ms
R1#

```

Default route sudah muncul.

## OSPF Authentication

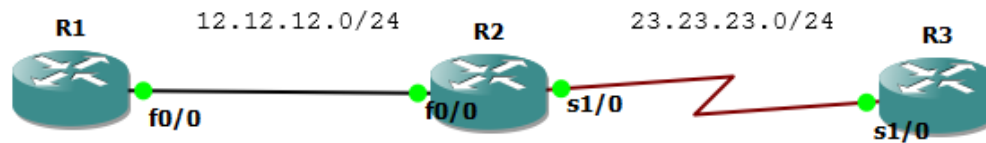

Ada 2 authentication dalam ospf.

1. Clear Text Authentication
2. MD5 Authentication

Konfigurasi Clear Text Authentication antara R1 dan R2.

```
R1(config)#int f0/0
R1(config-if)#ip ospf authentication
R1(config-if)#ip ospf authentication-key CISCO123

R2(config)#int f0/0
R2(config-if)#ip ospf authentication
R2(config-if)#ip ospf authentication-key CISCO123

R1(config-if)#do sh ip ospf int f0/0
FastEthernet0/0 is up, line protocol is up
  Internet Address 12.12.12.1/24, Area 0
  Process ID 1, Router ID 1.1.1.1, Network Type BROADCAST, Cost: 10
  Transmit Delay is 1 sec, State BDR, Priority 1
  Designated Router (ID) 2.2.2.2, Interface address 12.12.12.2
  Backup Designated router (ID) 1.1.1.1, Interface address 12.12.12.1
  Timer intervals configured, Hello 10, Dead 40, Wait 40, Retransmit 5
    oob-resync timeout 40
    Hello due in 00:00:00
  Supports Link-local Signaling (LLS)
  Cisco NSF helper support enabled
  IETF NSF helper support enabled
  Index 1/1, flood queue length 0
  Next 0x0(0)/0x0(0)
  Last flood scan length is 1, maximum is 1
  Last flood scan time is 0 msec, maximum is 0 msec
  Neighbor Count is 1, Adjacent neighbor count is 1
    Adjacent with neighbor 2.2.2.2 (Designated Router)
  Suppress hello for 0 neighbor(s)
  Simple password authentication enabled
R1(config-if)#
```

Konfigurasi MD5 Authentication antara R2 dan R3.

```
R2(config-if)#int s1/0
R2(config-if)#ip ospf authentication message-digest
R2(config-if)#ip ospf message-digest-key 13 md5 CISCO123

R3(config)#int s1/0
R3(config-if)#ip ospf authentication message-digest
R3(config-if)#ip ospf message-digest-key 13 md5 CISCO123
```

```

R3(config-if)#do sh ip ospf int s1/0
Serial1/0 is up, line protocol is up
  Internet Address 23.23.23.3/24, Area 0
  Process ID 3, Router ID 3.3.3.3, Network Type POINT_TO_POINT, Cost: 64
  Transmit Delay is 1 sec, State POINT_TO_POINT
  Timer intervals configured, Hello 10, Dead 40, Wait 40, Retransmit 5
    oob-resync timeout 40
    Hello due in 00:00:06
  Supports Link-local Signaling (LLS)
  Cisco NSF helper support enabled
  IETF NSF helper support enabled
  Index 2/2, flood queue length 0
  Next 0x0(0)/0x0(0)
  Last flood scan length is 1, maximum is 1
  Last flood scan time is 0 msec, maximum is 0 msec
  Neighbor Count is 1, Adjacent neighbor count is 1
    Adjacent with neighbor 2.2.2.2
  Suppress hello for 0 neighbor(s)
  Message digest authentication enabled
  Youngest key id is 13
R3(config-if)#

```

## OSPF Path Selection

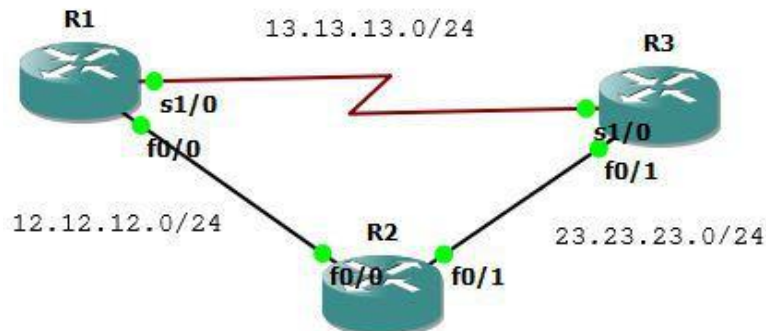

```

R1(config)#interface Loopback0
R1(config-if)#ip address 1.1.1.1 255.255.255.255
R1(config-if)#interface FastEthernet0/0
R1(config-if)#ip address 12.12.12.1 255.255.255.0
R1(config-if)#no sh
R1(config-if)#interface Serial1/0
R1(config-if)#ip address 13.13.13.1 255.255.255.0
R1(config-if)#no sh
R1(config-if)#router ospf 1
R1(config-router)#router-id 1.1.1.1
R1(config-router)#network 0.0.0.0 255.255.255.255 area 0

R2(config)#interface Loopback0
R2(config-if)#ip address 2.2.2.2 255.255.255.255
R2(config-if)#interface FastEthernet0/0

```

```

R2(config-if)#ip address 12.12.12.2 255.255.255.0
R2(config-if)#no sh
R2(config-if)#interface FastEthernet0/1
R2(config-if)#ip address 23.23.23.2 255.255.255.0
R2(config-if)#no sh
R2(config-if)#router ospf 2
R2(config-router)#router-id 2.2.2.2
R2(config-router)#network 0.0.0.0 255.255.255.255 area 0

R3(config)#interface Loopback0
R3(config-if)#ip address 3.3.3.3 255.255.255.255
R3(config-if)#interface FastEthernet0/1
R3(config-if)#ip address 23.23.23.3 255.255.255.0
R3(config-if)#no sh
R3(config-if)#interface Serial1/0
R3(config-if)#ip address 13.13.13.3 255.255.255.0
R3(config-if)#no sh
R3(config-if)#router ospf 3
R3(config-router)#router-id 3.3.3.3
R3(config-router)#network 0.0.0.0 255.255.255.255 area 0

```

## Cek jalurnya ternyata melalui R2.

```

R1#traceroute 3.3.3.3

Type escape sequence to abort.
Tracing the route to 3.3.3.3

 0 12.12.12.2 208 msec 4 msec 8 msec
 1 23.23.23.3 276 msec 80 msec 216 msec
R1#sh ip route 3.3.3.3
Routing entry for 3.3.3.3/32
  Known via "ospf 1", distance 110, metric 21, type intra area
  Last update from 12.12.12.2 on FastEthernet0/0, 00:02:07 ago
  Routing Descriptor Blocks:
    * 12.12.12.2, from 3.3.3.3, 00:02:07 ago, via FastEthernet0/0
      Route metric is 21, traffic share count is 1

R1#

```

Karena ospf menggunakan bandwidth maka jalur yang lebih dipilih adalah yang melalui FastEthernet. FastEthernet mempunyai metric 10 didapat dari 100.000.000:10.000.000(bandwidth terendah 10Mbps).

Tertulis metric nya 21 didapat dari metric FastEthernet R1-R2 dan R2-R3 masing-masing 10 dan loopback R3 1 sehingga totalnya 21.

## Coba shutdown FastEthernet pada R2.

```

R2(config)#interface FastEthernet0/0
R2(config-if)#shutdown

R1#sh ip route 3.3.3.3
Routing entry for 3.3.3.3/32
  Known via "ospf 1", distance 110, metric 65, type intra area
  Last update from 13.13.13.3 on Serial1/0, 00:00:18 ago
  Routing Descriptor Blocks:
    * 13.13.13.3, from 3.3.3.3, 00:00:18 ago, via Serial1/0

```

```
Route metric is 65, traffic share count is 1
```

```
R1#
```

Maka jalurnya berpindah ke serial. Serial mempunyai metric 64 didapat dari 100.000.000:1.544.000(pembulatan bandwidth serial).

Metric 65 didapat dari link serial R1-R3 yaitu 64 dan loopback R3 1 totalnya 65.

**Hidupkan lagi FastEthernet dan pastikan jalur kembali seperti semula.**

```
R2(config)#interface FastEthernet0/0  
R2(config-if)#no shutdown
```

```
R1#sh ip route 3.3.3.3  
Routing entry for 3.3.3.3/32  
  Known via "ospf 1", distance 110, metric 21, type intra area  
  Last update from 12.12.12.2 on FastEthernet0/0, 00:00:55 ago  
  Routing Descriptor Blocks:  
    * 12.12.12.2, from 3.3.3.3, 00:00:55 ago, via FastEthernet0/0  
      Route metric is 21, traffic share count is 1
```

```
R1#
```

**Untuk memindahkan jalur ke Serial, ubah parameter bandwidth FastEthernet.**

```
R1(config)#int fastEthernet0/0  
R1(config-if)#bandwidth 100  
R1#sh ip route 3.3.3.3  
Routing entry for 3.3.3.3/32  
  Known via "ospf 1", distance 110, metric 65, type intra area  
  Last update from 13.13.13.3 on Serial1/0, 00:00:12 ago  
  Routing Descriptor Blocks:  
    * 13.13.13.3, from 3.3.3.3, 00:00:12 ago, via Serial1/0  
      Route metric is 65, traffic share count is 1
```

```
R1#
```

**Maka jalur berpindah ke Serial.**

## Protocol Header

8	16	24	32
Version	Type	Length	
Router ID			
Area ID			
Checksum		Instance ID	Reserved
Data			

## Attributes

<b>Type</b>	Link-State
<b>Algorithm</b>	Dijkstra
<b>Metric</b>	Cost (Bandwidth)
<b>AD</b>	110
<b>Standard</b>	RFC 2328, 2740
<b>Protocols</b>	IP
<b>Transport</b>	IP/89
<b>Authentication</b>	Plaintext, MD5
<b>AllSPF Address</b>	224.0.0.5
<b>AllDR Address</b>	224.0.0.6

## Link State Advertisements

### Router Link (Type 1)

Lists neighboring routers and the cost to each; flooded within an area

### Network Link (Type 2)

Generated by a DR; lists all routers on an adjacent segment; flooded within an area

### Network Summary (Type 3)

Generated by an ABR and advertised among areas

### ASBR Summary (Type 4)

Injected by an ABR into the backbone to advertise the presence of an ASBR within an area

### External Link (Type 5)

Generated by an ASBR and flooded throughout the AS to advertise a route external to OSPF

### NSSA External Link (Type 7)

Generated by an ASBR in a not-so-stubby area; converted into a type 5 LSA by the ABR when leaving the area

## Metric Formula

$$\text{cost} = \frac{100,000 \text{ Kbps}^*}{\text{link speed}}$$

\* modifiable with  
`ospf auto-cost reference-bandwidth`

## Adjacency States

<b>1</b> Down	<b>5</b> Exstart
<b>2</b> Attempt	<b>6</b> Exchange
<b>3</b> Init	<b>7</b> Loading
<b>4</b> 2-Way	<b>8</b> Full

## DR/BDR Election

- The DR serves as a common point for all adjacencies on a multiaccess segment

- The BDR also maintains adjacencies with all routers in case the DR fails

- Election does not occur on point-to-point or multipoint links

- Default priority (0-255) is 1; highest priority wins; 0 cannot be elected

- DR preemption will not occur unless the current DR is reset

## Virtual Links

- Tunnel formed to join two areas across an intermediate

- Both end routers must share a common area

- At least one end must reside in area 0

- Cannot traverse stub areas

## Router Types

### Internal Router

All interfaces reside within the same area

### Backbone Router

A router with an interface in area 0 (the backbone)

### Area Border Router (ABR)

Connects two or more areas

### AS Boundary Router (ASBR)

Connects to additional routing domains; typically located in the backbone

## Area Types

### Standard Area

Default OSPF area type

### Stub Area

External link (type 5) LSAs are replaced with a default route

### Totally Stubby Area

Type 3, 4, and 5 LSAs are replaced with a default route

### Not So Stubby Area (NSSA)

A stub area containing an ASBR; type 5 LSAs are converted to type 7 within the area

## External Route Types

**E1** · Cost to the advertising ASBR plus the external cost of the route

**E2 (Default)** · Cost of the route as seen by the ASBR

## Troubleshooting

`show ip [route | protocols]`      `show ip ospf border-routers`

`show ip ospf interface`            `show ip ospf virtual-links`

`show ip ospf neighbor`            `debug ip ospf [...]`

## Network Types

	Nonbroadcast (NBMA)	Multipoint Broadcast	Multipoint Nonbroadcast	Broadcast	Point-to-Point
<b>DR/BDR Elected</b>	Yes	No	No	Yes	No
<b>Neighbor Discovery</b>	No	Yes	No	Yes	Yes
<b>Hello/Dead Timers</b>	30/120	30/120	30/120	10/40	10/40
<b>Defined By</b>	RFC 2328	RFC 2328	Cisco	Cisco	Cisco
<b>Supported Topology</b>	Full Mesh	Any	Any	Full Mesh	Point-to-Point

## Configuration Example

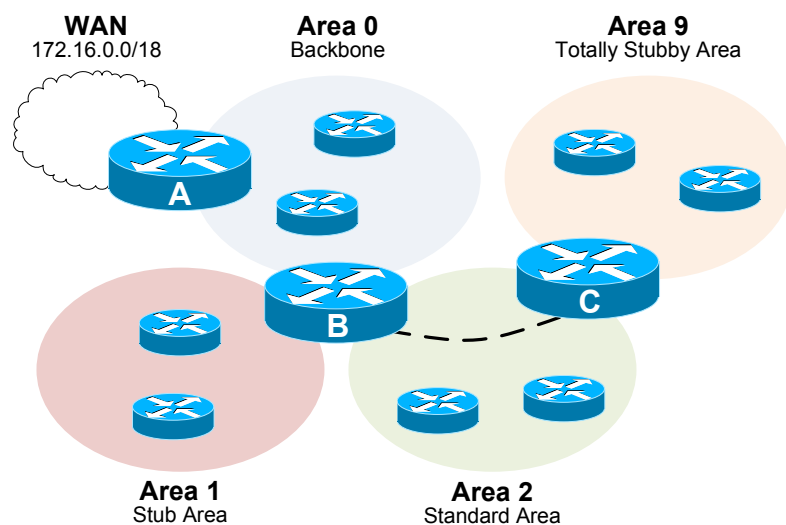

```

interface Serial0/0
description WAN Link
ip address 172.16.34.2 255.255.255.252
!
interface FastEthernet0/0
description Area 0
ip address 192.168.0.1 255.255.255.0
!
interface Loopback0
! Used as router ID
ip address 10.0.34.1 255.255.255.0
!
router ospf 100
! Advertising the WAN cloud to OSPF
redistribute static subnets
network 192.168.0.0 0.0.0.255 area 0
!
! Static route to the WAN cloud
ip route 172.16.0.0 255.255.192.0 172.16.34.1
    
```

**Router A**

```

interface Ethernet0/0
description Area 0
ip address 192.168.0.2 255.255.255.0
ip ospf 100 area 0
!
interface Ethernet0/1
description Area 2
ip address 192.168.2.1 255.255.255.0
ip ospf 100 area 2
! Optional MD5 authentication configured
ip ospf authentication message-digest
ip ospf message-digest-key 1 md5 FooBar
! Give B priority in DR election
ip ospf priority 100
!
interface Ethernet0/2
description Area 1
ip address 192.168.1.1 255.255.255.0
ip ospf 100 area 1
!
interface Loopback0
ip address 10.0.34.2 255.255.255.0
!
router ospf 100
! Define area 1 as a stub area
area 1 stub
! Virtual link from area 0 to area 9
area 2 virtual-link 10.0.34.3
    
```

**Router B**

```

interface Ethernet0/0
description Area 9
ip address 192.168.9.1 255.255.255.0
ip ospf 100 area 9
!
interface Ethernet0/1
description Area 2
ip address 192.168.2.2 255.255.255.0
ip ospf 100 area 2
! Optional MD5 authentication configured
ip ospf authentication message-digest
ip ospf message-digest-key 1 md5 FooBar
! Give C second priority (BDR) in election
ip ospf priority 50
!
!
!
!
interface Loopback0
ip address 10.0.34.3 255.255.255.0
!
router ospf 100
! Define area 9 as a totally stubby area
area 9 stub no-summary
! Virtual link from area 9 to area 0
area 2 virtual-link 10.0.34.2
    
```

**Router C**

# BGP

- BGP - iBGP Configuration
- BGP - iBGP Update via Loopback
- BGP – eBGP Configuration
- BGP – eBGP Configuration 2
- BGP – eBGP Configuration 3
- BGP – Next Hop Self
- BGP – Authentication
- BGP Route Reflector
- BGP Attribute - Origin
- BGP Attribute - Community
- BGP Attribute - Community Local-AS and Configuring Confederation
- BGP Aggregator
- BGP Attribute - Weight
- BGP Dualhoming – Load Balance
- BGP Dualhoming – Set Weight
- BGP Dualhoming – Set MED
- BGP Dualhoming – Set AS Path
- BGP Multihoming – Equal Load Balance
- BGP Multihoming – Unequal Load Balance



# BGP

## (Border Gateway Protocol)

Border Router Gateway (BGP) adalah protocol yang membentuk jaringan internet. BGP termasuk Exterior Gateway Protocol (EGP) atau bisa dikatakan satu-satunya protocol EGP. EGP menghubungkan Autonomous System (AS) yang satu dengan yang lain. Autonomous System sendiri adalah kumpulan router yang berada dibawah satu administrative domain.

BGP menggunakan TCP port 179 untuk transport protocol. Agar 2 router BGP saling peer atau saling menjadi neighbor, harus dibangun TCP connection terlebih dahulu, setelah itu baru dapat dilakukan pertukaran informasi routing BGP antara 2 router.

BGP menentukan route berdasarkan kebijakan AS yang dilewati (Policy Based). Berbeda dengan protocol IGP yang menentukan route berdasarkan shortest path.

Setiap router BGP mempunyai Router ID, IP loopback tertinggi akan menjadi router ID, jika tidak ada loopback maka akan dipilih IP interface tertinggi.

### eBGP dan iBGP

Ketika BGP berjalan didalam router-router dalam 1 AS, disebut iBGP. BGP yang berjalan antar AS disebut eBGP. eBGP harus direct connected antara 2 router, namun iBGP tidak harus direct connected selama ada IGP baik itu EIGRP, OSPF, atau static routing yang berjalan dan menjadikan 2 router BGP tadi reachable satu sama lain.

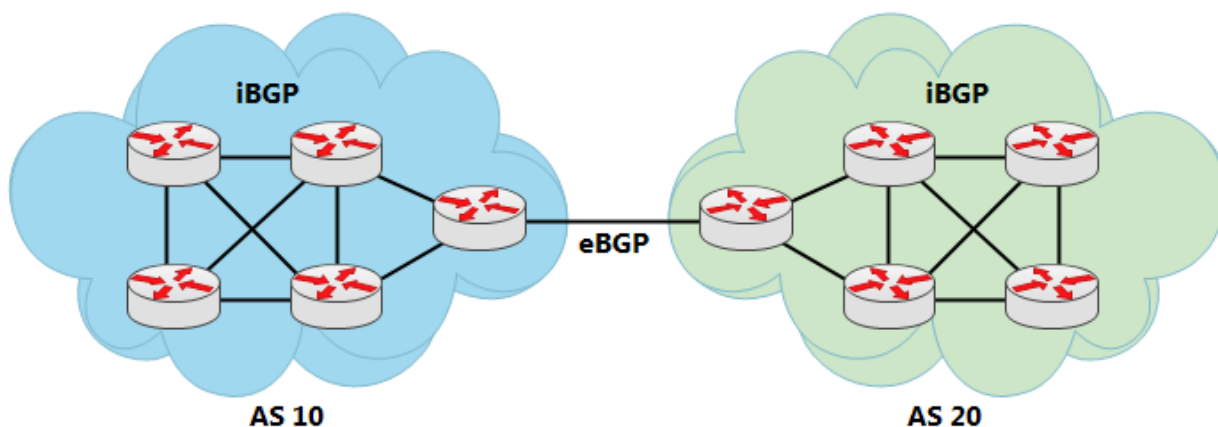

iBGP juga digunakan ketika suatu AS menjadi transit AS menuju AS lain. Pertanyaannya, Kenapa tidak menggunakan IGP saja? RIP, EIGRP atau OSPF lalu didistribute? Hal ini karena iBGP lebih efisien dan fleksibel untuk pertukaran routing information dalam suatu AS.

iBGP memberikan kebebasan untuk menentukan pintu keluar atau exit point suatu route dengan kesediaan attribute yang banyak. Alasan lainnya, banyak prefix akan memenuhi tabel routing jika dilakukan redistribute IGB dan BGP. Bayangkan saja, ada berapa ribu prefix di internet?

iBGP harus full mesh atau route reflector.

## Source Update via Loopback

Ketika interface yang dijadikan source update down, maka adjacency BGP juga akan down. Karena physical interface bisa down kapan saja, maka digunakan source update via loopback karena interface loopback tidak akan down. Umumnya digunakan dalam iBGP.

## Route Map

Dalam BGP, route map digunakan untuk mengontrol dan memodifikasi informasi routing untuk incoming routes dan outgoing routes.

## Attribute BGP

Attribute dalam BGP juga sering disebut path attribute. Ada beberapa jenis attribute dalam BGP:

WELL KNOWN = ada pada setiap BGP

- Mandatory = ter-include pada setiap route BGP, jika attribute ini tidak ada akan muncul error message. Harus disertakan dalam setiap update.
  - AS Path
  - Origin
  - Next Hop
- Discretionary = setiap BGP ... namun tidak tampil pada setiap route entry.
  - local preference
  - Atomic Aggregate

OPTIONAL

- Transitive
  - Community
  - Aggregator
- Non-Transitive

- Multi Exit Discriminator (MED)

## AS Path

Ketika packet update route dikirim melewati suatu AS, maka AS Number tersebut akan ditambahkan ke dalam packet update. Jadi AS Path adalah urutan AS Number yang dilewati suatu route untuk sampai ke destination. Karena hal ini juga, BGP disebut juga path-vector protocol.

AS Path digunakan untuk loop detection.

## Origin

Origin mendefinisikan asal dari suatu path information. Ada 3 value dari origin attribute.

- IGP (i) = berasal dari BGP baik iBGP atau eBGP dengan perintah network x.x.x.x mask x.x.x.x
- EGP (e) = berasal dari protocol EGP, saat ini sudah tidak ada.
- INCOMPLETE (?) = berasal dari protocol lain(RIP, EIGRP, OSPF, Static) yang didistribute ke BGP.

## BGP Route Selection Process

- Step 1: Prefer highest weight (local to router)
- Step 2: Prefer highest local preference (global within AS)
- Step 3: Prefer route originated by the local router
- Step 4: Prefer shortest AS path
- Step 5: Prefer lowest origin code (IGP < EGP < incomplete)
- Step 6: Prefer lowest MED (from other AS)
- Step 7: Prefer EBGP path over IBGP path
- Step 8: Prefer the path through the closest IGP neighbor
- Step 9: Prefer oldest route for EBGP paths
- Step 10: Prefer the path with the lowest neighbor BGP router ID

## BGP - iBGP Configuration

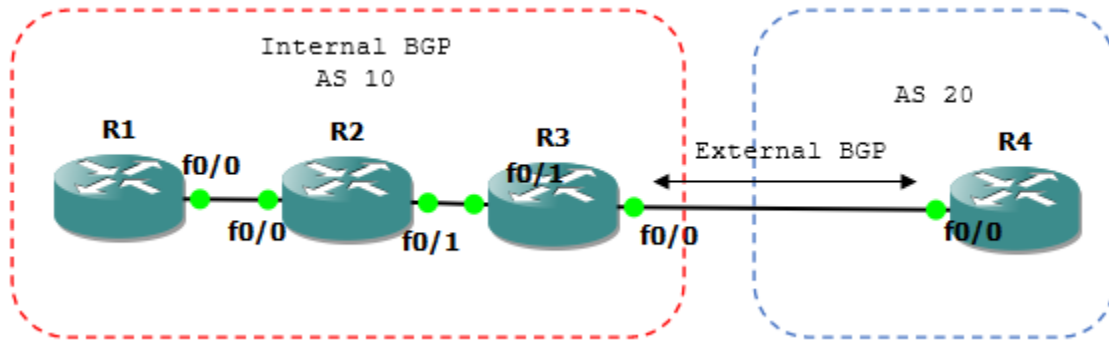

Ketikkan konfigurasi interface berikut.

```
R1(config)#int fa0/0
R1(config-if)#ip add 12.12.12.1 255.255.255.0
R1(config-if)#no sh
R1(config-if)#router ospf 1
R1(config-router)#net 0.0.0.0 255.255.255.255 area 0

R2(config)#int fa0/0
R2(config-if)#ip add 12.12.12.2 255.255.255.0
R2(config-if)#no sh
R2(config-if)#int f0/1
R2(config-if)#ip add 23.23.23.2 255.255.255.0
R2(config-if)#no sh
R2(config-if)#router ospf 1
R2(config-router)#net 0.0.0.0 255.255.255.255 area 0

R3(config)#int fa0/1
R3(config-if)#ip add 23.23.23.3 255.255.255.0
R3(config-if)#no sh
R3(config-if)#int fa0/0
R3(config-if)#ip add 34.34.34.3 255.255.255.0
R3(config-if)#no sh
R3(config-if)#router ospf 1
R3(config-router)#net 0.0.0.0 255.255.255.255 area 0
R3(config-router)#passive-interface fa0/0

R4(config)#int fa0/0
R4(config-if)#ip add 34.34.34.4 255.255.255.0
R4(config-if)#no sh
```

Oke pastikan R1 dapat mengeping R3.

```
R1(config-router)#do ping 23.23.23.3

Type escape sequence to abort.
Sending 5, 100-byte ICMP Echos to 23.23.23.3, timeout is 2 seconds:
!!!!
Success rate is 100 percent (5/5), round-trip min/avg/max = 20/63/120 ms
R1(config-router)#
```

Konfigurasi iBGP antara R1 dengan R3 terlebih dahulu.

```
R1(config)#router bgp 10
```

```
R1(config-router)#neighbor 23.23.23.3 remote-as 10
```

```
R3(config)#router bgp 10
```

```
R3(config-router)#neighbor 12.12.12.1 remote-as 10
```

Cek show ip bgp summary pastikan sudah neighbornya sudah ada.

```
R1(config-router)#do sh ip bgp sum
```

```
BGP router identifier 12.12.12.1, local AS number 10
```

```
BGP table version is 1, main routing table version 1
```

Neighbor	V	AS	MsgRcvd	MsgSent	TblVer	InQ	OutQ	Up/Down	State/PfxRcd
23.23.23.3	4	10	6	6	1	0	0	00:03:24	0

```
R1(config-router)#
```

```
R3(config-router)#do sh ip bgp sum
```

```
BGP router identifier 34.34.34.3, local AS number 10
```

```
BGP table version is 1, main routing table version 1
```

Neighbor	V	AS	MsgRcvd	MsgSent	TblVer	InQ	OutQ	Up/Down	State/PfxRcd
12.12.12.1	4	10	6	6	1	0	0	00:03:43	0

```
R3(config-router)#
```

**Oke sekarang buat interface loopback yang akan di advertise ke iBGP.**

```
R1(config-router)#int lo11
```

```
R1(config-if)#ip add 11.11.11.11 255.255.255.255
```

```
R1(config-if)#router bgp 10
```

```
R1(config-router)#network 11.11.11.11 mask 255.255.255.255
```

**Sekarang cek di R3, pastikan State/PfxRcd sudah tidak 0 lagi.**

```
R3(config-router)#do sh ip bgp sum
```

```
BGP router identifier 34.34.34.3, local AS number 10
```

```
BGP table version is 3, main routing table version 3
```

```
1 network entries using 120 bytes of memory
```

```
1 path entries using 52 bytes of memory
```

```
2/1 BGP path/bestpath attribute entries using 248 bytes of memory
```

```
0 BGP route-map cache entries using 0 bytes of memory
```

```
0 BGP filter-list cache entries using 0 bytes of memory
```

```
BGP using 420 total bytes of memory
```

```
BGP activity 1/0 prefixes, 1/0 paths, scan interval 60 secs
```

Neighbor	V	AS	MsgRcvd	MsgSent	TblVer	InQ	OutQ	Up/Down	State/PfxRcd
12.12.12.1	4	10	10	9	3	0	0	00:06:07	1

**Cek network yang diadvertise.**

```
R3(config-router)#do sh ip bgp
```

```
BGP table version is 3, local router ID is 34.34.34.3
```

```
Status codes: s suppressed, d damped, h history, * valid, > best, i -  
internal,
```

```
                  r RIB-failure, S Stale
```

```
Origin codes: i - IGP, e - EGP, ? - incomplete
```

Network	Next Hop	Metric	LocPrf	Weight	Path
r>i11.11.11.11/32	12.12.12.1	0	100	0	i

Cek ping dan sukses.

```
R3(config-router)#do ping 11.11.11.11

Type escape sequence to abort.
Sending 5, 100-byte ICMP Echos to 11.11.11.11, timeout is 2 seconds:
!!!!
Success rate is 100 percent (5/5), round-trip min/avg/max = 56/72/96 ms
R3(config-router)#
```

## BGP - iBGP Update via Loopback

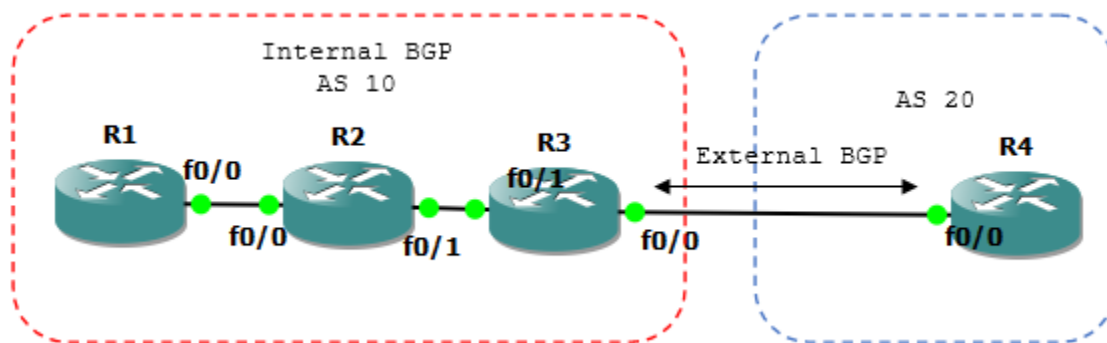

Interface fisik bisa down sewaktu-waktu sehingga adjacency BGP juga bisa drop. Karena itu adjacency BGP dilakukan melalui loopback.

Buat dulu interface loopback nya.

```
R1(config)#int lo0
R1(config-if)#ip add 1.1.1.1 255.255.255.255

R3(config)#int lo0
R3(config-if)#ip add 3.3.3.3 255.255.255.255

Sekarang konfigurasi loopback sebagai neighbor.

R1(config-if)#router bgp 10
R1(config-router)#neighbor 3.3.3.3 remote-as 10

R3(config-if)#router bgp 10
R3(config-router)#neighbor 1.1.1.1 remote-as 10
```

Oke sekarang cek neighbor BGP nya.

```
R3(config-router)#do sh ip bgp sum
BGP router identifier 34.34.34.3, local AS number 10
BGP table version is 3, main routing table version 3
1 network entries using 120 bytes of memory
1 path entries using 52 bytes of memory
2/1 BGP path/bestpath attribute entries using 248 bytes of memory
0 BGP route-map cache entries using 0 bytes of memory
```

```
0 BGP filter-list cache entries using 0 bytes of memory
BGP using 420 total bytes of memory
BGP activity 1/0 prefixes, 1/0 paths, scan interval 60 secs
```

Neighbor	V	AS	MsgRcvd	MsgSent	TblVer	InQ	OutQ	Up/Down	State/PfxRcd
1.1.1.1	4	10	0	0	0	0	0	never	Active
12.12.12.1	4	10	8	7	3	0	0	00:04:20	1

**Ups... ternyata adjacency melalui loopback belum berhasil, walau state sudah active tapi PfxRcd masih belum ada. Tambahkan perintah berikut.**

```
R3(config-router)#neighbor 1.1.1.1 update-source loopback0
*Mar 1 00:06:33.639: %BGP-5-ADJCHANGE: neighbor 1.1.1.1 Up
```

```
R1(config-router)#neighbor 3.3.3.3 update-source loopback0
*Mar 1 00:06:20.067: %BGP-5-ADJCHANGE: neighbor 3.3.3.3 Up
```

**Oke cek lagi.**

```
R3(config-router)#do sh ip bgp sum
BGP router identifier 34.34.34.3, local AS number 10
BGP table version is 3, main routing table version 3
1 network entries using 120 bytes of memory
2 path entries using 104 bytes of memory
2/1 BGP path/bestpath attribute entries using 248 bytes of memory
0 BGP route-map cache entries using 0 bytes of memory
0 BGP filter-list cache entries using 0 bytes of memory
BGP using 472 total bytes of memory
BGP activity 1/0 prefixes, 2/0 paths, scan interval 60 secs
```

Neighbor	V	AS	MsgRcvd	MsgSent	TblVer	InQ	OutQ	Up/Down	State/PfxRcd
1.1.1.1	4	10	11	10	3	0	0	00:06:02	1
12.12.12.1	4	10	15	14	3	0	0	00:11:08	1

```
R3(config-router)#
```

**Sip... sudah berubah. Hapus dulu adjacency 12.12.12.1 dan 23.23.23.3.**

```
R3(config-router)#no neighbor 12.12.12.1
*Mar 1 00:14:47.347: %BGP-5-ADJCHANGE: neighbor 12.12.12.1 Down Neighbor
deleted
```

```
R1(config-router)#
*Mar 1 00:14:33.951: %BGP-5-ADJCHANGE: neighbor 23.23.23.3 Down Peer closed
the session
R1(config-router)#no neighbor 23.23.23.3
```

**Oke cek lagi dan neighbor nya hanya ada 1.**

```
R3(config-router)#do sh ip bgp sum
BGP router identifier 34.34.34.3, local AS number 10
BGP table version is 4, main routing table version 4
1 network entries using 120 bytes of memory
1 path entries using 52 bytes of memory
2/1 BGP path/bestpath attribute entries using 248 bytes of memory
0 BGP route-map cache entries using 0 bytes of memory
0 BGP filter-list cache entries using 0 bytes of memory
BGP using 420 total bytes of memory
BGP activity 1/0 prefixes, 2/1 paths, scan interval 60 secs
```

```

Neighbor      V      AS  MsgRcvd  MsgSent   TblVer   InQ  OutQ  Up/Down
State/PfxRcd
1.1.1.1       4      10      14       13        4     0     0 00:09:13      1
R3(config-router)#

```

Dan yang terakhir, tes ping.

```

R3(config-router)#do ping 11.11.11.11

Type escape sequence to abort.
Sending 5, 100-byte ICMP Echos to 11.11.11.11, timeout is 2 seconds:
!!!!
Success rate is 100 percent (5/5), round-trip min/avg/max = 44/87/140 ms
R3(config-router)#

```

Siipp... berhasil.

## BGP – eBGP Configuration

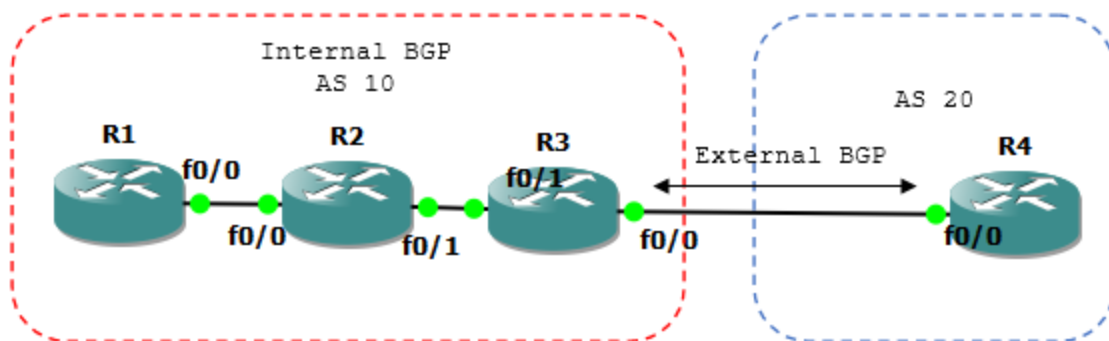

Konfigurasi eBGP pada R3 dan R4.

```

R3(config)#router bgp 10
R3(config-router)#neighbor 34.34.34.4 remote-as 20
*Mar  1 00:03:03.087: %BGP-5-ADJCHANGE: neighbor 34.34.34.4 Up

R4(config)#router bgp 20
R4(config-router)#neighbor 34.34.34.3 remote-as 10
*Mar  1 00:02:03.487: %BGP-5-ADJCHANGE: neighbor 34.34.34.3 Up

```

Cek neighbor.

```

R4(config-router)#do sh ip bgp sum
Neighbor      V      AS  MsgRcvd  MsgSent   TblVer   InQ  OutQ  Up/Down
State/PfxRcd
34.34.34.3    4      10      5         4         2     0     0 00:00:02      1
R4(config-router)#

R3(config-router)#do sh ip bgp sum
Neighbor      V      AS  MsgRcvd  MsgSent   TblVer   InQ  OutQ  Up/Down
State/PfxRcd
1.1.1.1       4      10      7         6         3     0     0 00:03:49      1
34.34.34.4    4      20      6         7         3     0     0 00:02:06      0

```



Oke sekarang cek tabek bgp dan tes ping.

```
R4#sh ip bgp
BGP table version is 2, local router ID is 34.34.34.4
Status codes: s suppressed, d damped, h history, * valid, > best, i -
internal,
                r RIB-failure, S Stale
Origin codes: i - IGP, e - EGP, ? - incomplete

   Network          Next Hop          Metric LocPrf Weight Path
*> 11.11.11.11/32   34.34.34.3                0 10 i
R4(config-router)#do ping 11.11.11.11

Type escape sequence to abort.
Sending 5, 100-byte ICMP Echos to 11.11.11.11, timeout is 2 seconds:
!!!!!!
Success rate is 100 percent (5/5), round-trip min/avg/max = 68/94/148 ms
R4(config-router)#
```

Berhasil. Path menunjukkan bahwa network 11.11.11.11 diadvertise ke dalam iBGP (ditandai dengan i) dari AS 10.

Oke fix.

## BGP – eBGP Configuration 2

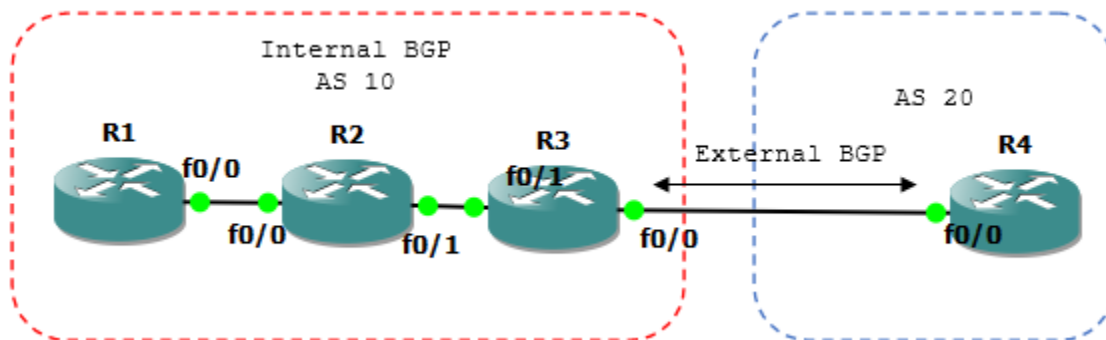

Oke lanjutan lab sebelumnya. Buatlah interface loopback di R4 dan advertise ke BGP 20.

```
R4(config)#int lo44
*Mar  1 00:18:42.419: %LINEPROTO-5-UPDOWN: Line protocol on Interface
Loopback44, changed state to up
R4(config-if)#ip add 44.44.44.44 255.255.255.255
R4(config-if)#router bgp 20
R4(config-router)#network 44.44.44.44 mask 255.255.255.255
R4(config-router)#do sh ip bgp
BGP table version is 3, local router ID is 34.34.34.4
Status codes: s suppressed, d damped, h history, * valid, > best, i -
internal,
                r RIB-failure, S Stale
Origin codes: i - IGP, e - EGP, ? - incomplete
```

```

      Network          Next Hop           Metric LocPrf Weight Path
*> 11.11.11.11/32    34.34.34.3              0 10 i
*> 44.44.44.44/32    0.0.0.0                  0      32768 i
R4(config-router)#

```

**Sekarang coba ping dari R3.**

```

R3#ping 44.44.44.44

Type escape sequence to abort.
Sending 5, 100-byte ICMP Echos to 44.44.44.44, timeout is 2 seconds:
!!!!
Sukses

```

**Klo dari R1?**

```

Type escape sequence to abort.
Sending 5, 100-byte ICMP Echos to 44.44.44.44, timeout is 2 seconds:
UUUUU
Success rate is 0 percent (0/5)

R1#sh ip route
Gateway of last resort is not set

    34.0.0.0/24 is subnetted, 1 subnets
O       34.34.34.0 [110/30] via 12.12.12.2, 00:23:17, FastEthernet0/0
    1.0.0.0/32 is subnetted, 1 subnets
C       1.1.1.1 is directly connected, Loopback0
    3.0.0.0/32 is subnetted, 1 subnets
O       3.3.3.3 [110/21] via 12.12.12.2, 00:23:17, FastEthernet0/0
    23.0.0.0/24 is subnetted, 1 subnets
O       23.23.23.0 [110/20] via 12.12.12.2, 00:23:17, FastEthernet0/0
    11.0.0.0/32 is subnetted, 1 subnets
C       11.11.11.11 is directly connected, Loopback11
    12.0.0.0/24 is subnetted, 1 subnets
C       12.12.12.0 is directly connected, FastEthernet0/0
    44.0.0.0/32 is subnetted, 1 subnets
B       44.44.44.44 [200/0] via 34.34.34.4, 00:04:24
R1#

```

**Upssss... unreachable. Padahal network 44.44.44.44 sudah ada di tabel routing. Coba di traceroute dulu ah.**

```

R1#traceroute 44.44.44.44

Type escape sequence to abort.
Tracing the route to 44.44.44.44

  1 12.12.12.2 76 msec 80 msec 44 msec
  2 12.12.12.2 !H  !H  !H
R1#

```

**Ternyata berhenti di R2. Lalu bagaimana solusinya? Cek tabel routing pada R4.**

```

R4#sh ip ro
Codes: C - connected, S - static, R - RIP, M - mobile, B - BGP
       D - EIGRP, EX - EIGRP external, O - OSPF, IA - OSPF inter area

```

```

N1 - OSPF NSSA external type 1, N2 - OSPF NSSA external type 2
E1 - OSPF external type 1, E2 - OSPF external type 2
i - IS-IS, su - IS-IS summary, L1 - IS-IS level-1, L2 - IS-IS level-2
ia - IS-IS inter area, * - candidate default, U - per-user static
route
o - ODR, P - periodic downloaded static route

Gateway of last resort is not set

34.0.0.0/24 is subnetted, 1 subnets
C 34.34.34.0 is directly connected, FastEthernet0/0
23.0.0.0/24 is subnetted, 1 subnets
B 23.23.23.0 [20/0] via 34.34.34.3, 00:01:22
11.0.0.0/32 is subnetted, 1 subnets
B 11.11.11.11 [20/0] via 34.34.34.3, 00:02:38
44.0.0.0/32 is subnetted, 1 subnets
C 44.44.44.44 is directly connected, Loopback44
R4#

```

**Ternyata hanya ada IP 11.11.11.11 yang dikenali. Gunakan IP tersebut sebagai source.**

```

R1#ping
Protocol [ip]:
Target IP address: 44.44.44.44
Repeat count [5]:
Datagram size [100]:
Timeout in seconds [2]:
Extended commands [n]: y
Source address or interface: 11.11.11.11
Type of service [0]:
Set DF bit in IP header? [no]:
Validate reply data? [no]:
Data pattern [0xABCD]:
Loose, Strict, Record, Timestamp, Verbose[none]:
Sweep range of sizes [n]:
Type escape sequence to abort.
Sending 5, 100-byte ICMP Echos to 44.44.44.44, timeout is 2 seconds:
Packet sent with a source address of 11.11.11.11
UUUUU
Success rate is 0 percent (0/5)
R1#

```

**Ups... ternyata masih belum bisa. Disitu kadang saya merasa sedih...**

**Caranya... angkat R2 menjadi iBGP juga. Syarat iBGP adalah full mesh atau bisa juga route reflector. Klo full mesh berarti setiap router harus punya satu link ke setiap router lain.**

```

R2(config)#int lo0
R2(config-if)#ip add 2.2.2.2 255.255.255.255
R2(config-if)#router bgp 10
R2(config-router)#neighbor 1.1.1.1 remote-as 10
R2(config-router)#neighbor 1.1.1.1 up lo0
R2(config-router)#neighbor 3.3.3.3 remote-as 10
R2(config-router)#neighbor 3.3.3.3 up lo0

R1(config)#router bgp 10

```

```
R1(config-router)#neighbor 2.2.2.2 remote-as 10
R1(config-router)#neighbor 2.2.2.2 up lo0

R3(config)#router bgp 10
R3(config-router)#neighbor 2.2.2.2 remot 10
R3(config-router)#neighbor 2.2.2.2 up lo0
```

### Oke cek lagi.

```
R1#ping
Protocol [ip]:
Target IP address: 44.44.44.44
Repeat count [5]:
Datagram size [100]:
Timeout in seconds [2]:
Extended commands [n]: y
Source address or interface: 11.11.11.11
Type of service [0]:
Set DF bit in IP header? [no]:
Validate reply data? [no]:
Data pattern [0xABCD]:
Loose, Strict, Record, Timestamp, Verbose[none]:
Sweep range of sizes [n]:
Type escape sequence to abort.
Sending 5, 100-byte ICMP Echos to 44.44.44.44, timeout is 2 seconds:
Packet sent with a source address of 11.11.11.11
!!!!
Success rate is 100 percent (5/5), round-trip min/avg/max = 144/196/264 ms
R1#
```

Hal ini dikarenakan secara default source yang dipakai untuk ping adalah interface physicalnya. Jadi tinggal advertise network interfacenya ke dalam BGP.

```
R1(config)#router bgp 10
R1(config-router)#network 12.12.12.0 mask 255.255.255.0
R1(config-router)#do ping 44.44.44.44

Type escape sequence to abort.
Sending 5, 100-byte ICMP Echos to 44.44.44.44, timeout is 2 seconds:
!!!!
Success rate is 100 percent (5/5), round-trip min/avg/max = 64/150/204 ms
R1(config-router)#
```

### Oke sekarang coba ping 44.44.44.44 dari R2.

```
R2#ping 44.44.44.44

Type escape sequence to abort.
Sending 5, 100-byte ICMP Echos to 44.44.44.44, timeout is 2 seconds:
.....
Success rate is 0 percent (0/5)
R2#tra
R2#traceroute 44.44.44.44

Type escape sequence to abort.
Tracing the route to 44.44.44.44

 1 23.23.23.3 72 msec 72 msec 68 msec
```

```
2 * * *
3
R2#
```

Gagal ya? Trace nya berakhir di R3. Klo begitu advertise network 23.23.23.0 pada R3 ke BGP.

```
R3(config)#router bgp 10
R3(config-router)#net 23.23.23.0 mask 255.255.255.0

R2#ping 44.44.44.44

Type escape sequence to abort.
Sending 5, 100-byte ICMP Echos to 44.44.44.44, timeout is 2 seconds:
!!!!
Success rate is 100 percent (5/5), round-trip min/avg/max = 68/102/144 ms
R2#
```

Good Job...

## BGP – eBGP Configuration 3

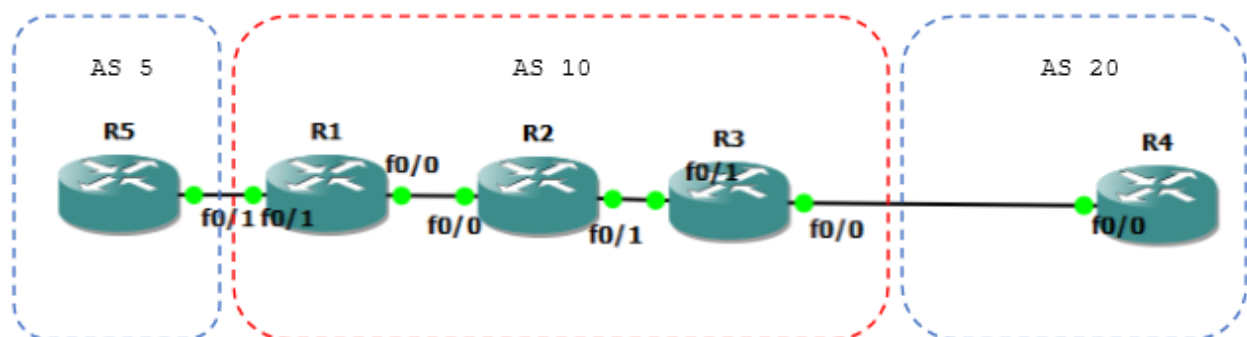

Masih pake topologi sebelumnya cuma tambahin R5 disebelah kiri.

```
R1(config)#int fa0/1
R1(config-if)#ip add 15.15.15.1 255.255.255.0
R1(config-if)#no sh
R1(config-if)#router bgp 10
R1(config-router)#nei 15.15.15.5 remot 5

R5(config)#int fa0/1
R5(config-if)#ip add 15.15.15.5 255.255.255.0
R5(config-if)#no sh
R5(config-if)#router bgp 5
R5(config-router)#neighbor 15.15.15.1 remot 10

R5(config-router)#do sh ip bgp
BGP table version is 4, local router ID is 15.15.15.5
Status codes: s suppressed, d damped, h history, * valid, > best, i -
internal,
                r RIB-failure, S Stale
Origin codes: i - IGP, e - EGP, ? - incomplete
```

```

      Network          Next Hop           Metric LocPrf Weight Path
*> 11.11.11.11/32    15.15.15.1             0           0 10 i
*> 12.12.12.0/24    15.15.15.1             0           0 10 i
*> 44.44.44.44/32   15.15.15.1             0           0 10 20 i
R5(config-router)#

```

## Sekarang ping dan trace ke R4 pada AS 20.

```

R5#ping 44.44.44.44

Type escape sequence to abort.
Sending 5, 100-byte ICMP Echos to 44.44.44.44, timeout is 2 seconds:
.....
Success rate is 0 percent (0/5)
R5#trac 44.44.44.44

Type escape sequence to abort.
Tracing the route to 44.44.44.44

  0  15.15.15.1  92 msec  76 msec  92 msec
  1  12.12.12.2  [AS 10] 96 msec  60 msec  60 msec
  2  23.23.23.3 152 msec 156 msec 88 msec
  3
  4
R5#

```

## Ups gagal... solusinya R5 harus mengadvertise source network nya.

```

R5(config)#router bgp 5
R5(config-router)#network 15.15.15.0 mask 255.255.255.0
R5#ping 44.44.44.44

Type escape sequence to abort.
Sending 5, 100-byte ICMP Echos to 44.44.44.44, timeout is 2 seconds:
!!!!
Success rate is 100 percent (5/5), round-trip min/avg/max = 188/251/304 ms
R5#

```

## Sekarang kita lakukan sedikit percobaan. Hapus bgp 10 pada R2. Sebelumnya copy dulu konfigurasi BGP nya ke notepad.

```

R2#sh run | s r b
router bgp 10
  no synchronization
  bgp log-neighbor-changes
  neighbor 1.1.1.1 remote-as 10
  neighbor 1.1.1.1 update-source Loopback0
  neighbor 3.3.3.3 remote-as 10
  neighbor 3.3.3.3 update-source Loopback0
  no auto-summary

R2(config)#no router bgp 10
*Mar  1 00:10:49.335: %BGP-5-ADJCHANGE: neighbor 1.1.1.1 Down BGP protocol
initialization
*Mar  1 00:10:49.335: %BGP-5-ADJCHANGE: neighbor 3.3.3.3 Down BGP protocol
initialization

```

## Cek ping R5 ke R4.

```
R5#ping 44.44.44.44
```

```
Type escape sequence to abort.  
Sending 5, 100-byte ICMP Echos to 44.44.44.44, timeout is 2 seconds:  
UUUUU  
Success rate is 0 percent (0/5)  
R5#
```

Sekarang balikin lagi konfigurasi BGP 10 ke R2 dan cek lagi.

```
R5#ping 44.44.44.44
```

```
Type escape sequence to abort.  
Sending 5, 100-byte ICMP Echos to 44.44.44.44, timeout is 2 seconds:  
!!!!  
Success rate is 100 percent (5/5), round-trip min/avg/max = 156/218/276 ms  
R5#
```

Oke sip. Kesimpulannya? ... Tulis sendiri ya.

## BGP – Next Hop Self

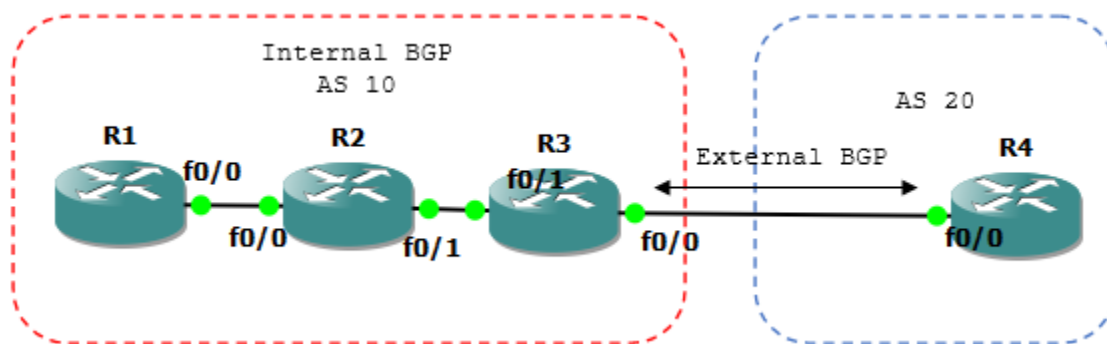

Lanjutkan lab 4 yang lebih simpel dan enteng.

```
R2#sh ip route
```

```
Gateway of last resort is not set
```

```
34.0.0.0/24 is subnetted, 1 subnets  
O 34.34.34.0 [110/20] via 23.23.23.3, 00:01:53, FastEthernet0/1  
1.0.0.0/32 is subnetted, 1 subnets  
O 1.1.1.1 [110/11] via 12.12.12.1, 00:01:53, FastEthernet0/0  
2.0.0.0/32 is subnetted, 1 subnets  
C 2.2.2.2 is directly connected, Loopback0  
3.0.0.0/32 is subnetted, 1 subnets  
O 3.3.3.3 [110/11] via 23.23.23.3, 00:01:53, FastEthernet0/1  
23.0.0.0/24 is subnetted, 1 subnets  
C 23.23.23.0 is directly connected, FastEthernet0/1  
11.0.0.0/32 is subnetted, 1 subnets  
O 11.11.11.11 [110/11] via 12.12.12.1, 00:01:54, FastEthernet0/0  
12.0.0.0/24 is subnetted, 1 subnets  
C 12.12.12.0 is directly connected, FastEthernet0/0  
44.0.0.0/32 is subnetted, 1 subnets
```

```

B 44.44.44.44 [200/0] via 34.34.34.4, 00:01:06
R2#sh ip bgp
BGP table version is 8, local router ID is 2.2.2.2
Status codes: s suppressed, d damped, h history, * valid, > best, i -
internal,
                r RIB-failure, S Stale
Origin codes: i - IGP, e - EGP, ? - incomplete

   Network          Next Hop          Metric LocPrf Weight Path
r>i11.11.11.11/32   1.1.1.1            0     100     0  i
r>i12.12.12.0/24   1.1.1.1            0     100     0  i
r>i23.23.23.0/24   3.3.3.3            0     100     0  i
*>i44.44.44.44/32  34.34.34.4         0     100     0 20  i
R2#

```

**Ketika default network ospf R3 dihapus, maka route nya hilang.**

```

R3(config)#router ospf 1
R3(config-router)#no network 0.0.0.0 255.255.255.255 area 0
Gateway of last resort is not set

   1.0.0.0/32 is subnetted, 1 subnets
O    1.1.1.1 [110/11] via 12.12.12.1, 00:05:18, FastEthernet0/0
   2.0.0.0/32 is subnetted, 1 subnets
C    2.2.2.2 is directly connected, Loopback0
   23.0.0.0/24 is subnetted, 1 subnets
C    23.23.23.0 is directly connected, FastEthernet0/1
   11.0.0.0/32 is subnetted, 1 subnets
O    11.11.11.11 [110/11] via 12.12.12.1, 00:05:18, FastEthernet0/0
   12.0.0.0/24 is subnetted, 1 subnets
C    12.12.12.0 is directly connected, FastEthernet0/0
R2#sh ip bgp
BGP table version is 10, local router ID is 2.2.2.2
Status codes: s suppressed, d damped, h history, * valid, > best, i -
internal,
                r RIB-failure, S Stale
Origin codes: i - IGP, e - EGP, ? - incomplete

   Network          Next Hop          Metric LocPrf Weight Path
r>i11.11.11.11/32   1.1.1.1            0     100     0  i
r>i12.12.12.0/24   1.1.1.1            0     100     0  i
* i23.23.23.0/24   3.3.3.3            0     100     0  i
* i44.44.44.44/32  34.34.34.4         0     100     0 20  i
R2#

```

**iBGP tidak memilih next-hop nya sendiri, dalam hal ini dia numpang sama OSPF. Karena OSPF dihapus, maka route BGP tidak muncul dalam tabel routing. Namun, kita bisa mengkonfigurasi next-hop secara manual pada iBGP.**

```

R2(config-router)#router bgp 10
R2(config-router)#neighbor 23.23.23.3 remot 10

R3(config-router)#router bgp 10
R3(config-router)#neighbor 23.23.23.2 remot 10
R3(config-router)#neighbor 23.23.23.2 next-hop-self

```

**Sekarang cek lagi.**



```

R2#sh ip bgp sum
BGP router identifier 2.2.2.2, local AS number 10
BGP table version is 13, main routing table version 13
4 network entries using 480 bytes of memory
4 path entries using 208 bytes of memory
3/2 BGP path/bestpath attribute entries using 372 bytes of memory
1 BGP AS-PATH entries using 24 bytes of memory
0 BGP route-map cache entries using 0 bytes of memory
0 BGP filter-list cache entries using 0 bytes of memory
BGP using 1084 total bytes of memory
BGP activity 6/2 prefixes, 6/2 paths, scan interval 60 secs

Neighbor          V    AS MsgRcvd MsgSent   TblVer  InQ  OutQ Up/Down
State/PfxRcd
1.1.1.1           4    10     18     16     13    0    0 00:13:04    2
3.3.3.3           4    10     10     12      0    0    0 00:06:10 Active
23.23.23.3       4    10      8      6     13    0    0 00:02:33    2
R2#sh ip bgp
BGP table version is 13, local router ID is 2.2.2.2
Status codes: s suppressed, d damped, h history, * valid, > best, i -
internal,
                r RIB-failure, S Stale
Origin codes: i - IGP, e - EGP, ? - incomplete

   Network          Next Hop          Metric LocPrf Weight Path
r>i11.11.11.11/32  1.1.1.1             0     100     0  i
r>i12.12.12.0/24  1.1.1.1             0     100     0  i
r>i23.23.23.0/24  23.23.23.3         0     100     0  i
*>i44.44.44.44/32 23.23.23.3         0     100     0 20  i
R2#sh ip route
Codes: C - connected, S - static, R - RIP, M - mobile, B - BGP
       D - EIGRP, EX - EIGRP external, O - OSPF, IA - OSPF inter area
       N1 - OSPF NSSA external type 1, N2 - OSPF NSSA external type 2
       E1 - OSPF external type 1, E2 - OSPF external type 2
       i - IS-IS, su - IS-IS summary, L1 - IS-IS level-1, L2 - IS-IS level-2
       ia - IS-IS inter area, * - candidate default, U - per-user static
route
       o - ODR, P - periodic downloaded static route

Gateway of last resort is not set

  1.0.0.0/32 is subnetted, 1 subnets
O    1.1.1.1 [110/11] via 12.12.12.1, 00:13:39, FastEthernet0/0
  2.0.0.0/32 is subnetted, 1 subnets
C    2.2.2.2 is directly connected, Loopback0
  23.0.0.0/24 is subnetted, 1 subnets
C    23.23.23.0 is directly connected, FastEthernet0/1
  11.0.0.0/32 is subnetted, 1 subnets
O    11.11.11.11 [110/11] via 12.12.12.1, 00:13:39, FastEthernet0/0
  12.0.0.0/24 is subnetted, 1 subnets
C    12.12.12.0 is directly connected, FastEthernet0/0
  44.0.0.0/32 is subnetted, 1 subnets
B    44.44.44.44 [200/0] via 23.23.23.3, 00:02:49
R2#ping 44.44.44.44

Type escape sequence to abort.
Sending 5, 100-byte ICMP Echos to 44.44.44.44, timeout is 2 seconds:

```

```
!!!!!  
Success rate is 100 percent (5/5), round-trip min/avg/max = 48/78/112 ms  
R2#
```

Sip dah.

## BGP – Authentication

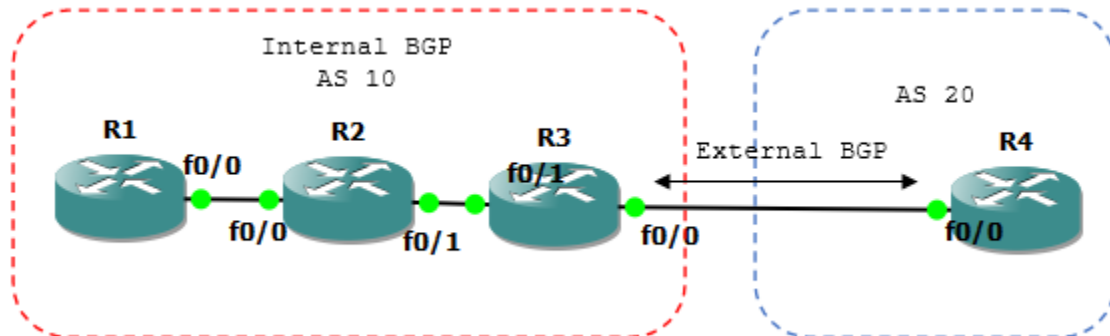

```
R2(config)#router bgp 10  
R2(config-router)#neighbor 1.1.1.1 password ?  
  <0-7> Encryption type (0 to disable encryption, 7 for proprietary)  
  
R2(config-router)#neighbor 1.1.1.1 password 0 HAHAHA  
  
R1(config)#router bgp 10  
R1(config-router)#neighbor 2.2.2.2 password 0 HAHAHA  
*Mar 1 00:05:09.383: %BGP-3-NOTIFICATION: received from neighbor 2.2.2.2  
4/0 (hold time expired) 0 bytes  
R1(config)#  
*Mar 1 00:05:09.383: %BGP-5-ADJCHANGE: neighbor 2.2.2.2 Down BGP  
Notification received  
*Mar 1 00:05:36.667: %BGP-5-ADJCHANGE: neighbor 2.2.2.2 Up
```

Oke selesai. Gampangkan.

## BGP Route Reflector

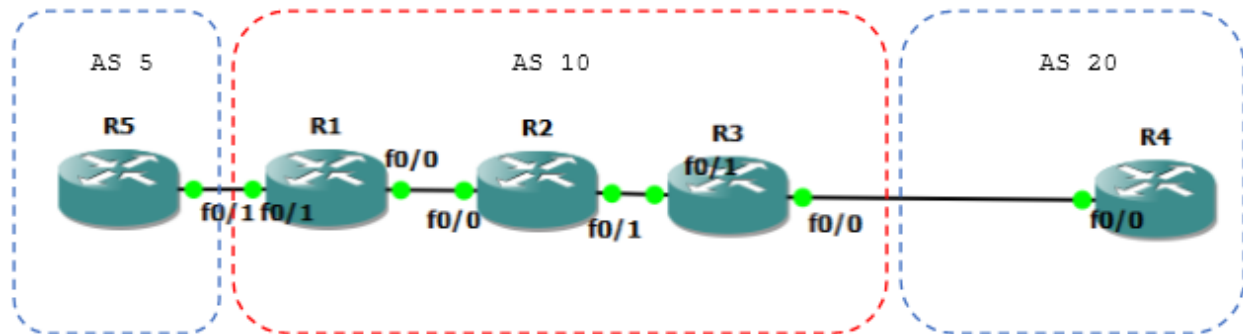

Balik lagi ke topologi lab 5. Pada iBGP, peers nya harus full mesh. Masalah terjadi ketika ada router baru yang tersambung. Artinya harus dikonfigurasi peer yang baru satu per satu.

Solusinya adalah menjadikan salah satu router menjadi Route Reflector(RR) sehingga hanya RR yang full mesh ke semua router sedang router lain hanya perlu peer ke RR.

Yang mau kita konfigurasi adalah iBGP AS 10. R1 akan kita jadikan RR.

```
R1#sh run | s r b
router bgp 10
no synchronization
bgp log-neighbor-changes
network 11.11.11.11 mask 255.255.255.255
network 12.12.12.0 mask 255.255.255.0
neighbor 2.2.2.2 remote-as 10
neighbor 2.2.2.2 update-source Loopback0
neighbor 3.3.3.3 remote-as 10
neighbor 3.3.3.3 update-source Loopback0
neighbor 15.15.15.5 remote-as 5
no auto-summary
R1#
```

Karena sudah dikonfigurasi sebelumnya, tinggal mengeset route-reflector-client aja.

```
R1(config)#router bgp 10
R1(config-router)#neighbor 2.2.2.2 route-reflector-client
R1(config-router)#neighbor 3.3.3.3 route-reflector-client
*Mar 1 00:11:20.291: %BGP-5-ADJCHANGE: neighbor 2.2.2.2 Down RR client
config change
R1(config-router)#neighbor 2.2.2.2 route-reflector-client
*Mar 1 00:11:22.543: %BGP-5-ADJCHANGE: neighbor 2.2.2.2 Up
*Mar 1 00:11:30.891: %BGP-5-ADJCHANGE: neighbor 3.3.3.3 Down RR client
config change
*Mar 1 00:11:33.275: %BGP-5-ADJCHANGE: neighbor 3.3.3.3 Up
```

Sekarang hapus peer pada R2 dan R3 yang tidak mengarah ke R1.

```
R2(config-router)#no neighbor 3.3.3.3 remot 10
R3(config-router)#no neighbor 2.2.2.2 remot 10
```

Untuk pengecekan, buat interface loopback dan advertise ke iBGP.

```
R2(config)#int lo22
R2(config-if)#ip add 22.22.22.22 255.255.255.255
R2(config-if)#router bgp 10
R2(config-router)#net 22.22.22.22 mask 255.255.255.255
```

Pastikan R1 dan R3 bisa ping.

```
R1#ping 22.22.22.22

Type escape sequence to abort.
Sending 5, 100-byte ICMP Echos to 22.22.22.22, timeout is 2 seconds:
!!!!
Success rate is 100 percent (5/5), round-trip min/avg/max = 16/52/80 ms
R1#
R3#ping 22.22.22.22

Type escape sequence to abort.
Sending 5, 100-byte ICMP Echos to 22.22.22.22, timeout is 2 seconds:
!!!!
Success rate is 100 percent (5/5), round-trip min/avg/max = 20/53/88 ms
R3#
```

Dan ketika dicek, peer atau networknya hanya ada satu.

```
R2#sh ip bgp sum
BGP router identifier 2.2.2.2, local AS number 10
BGP table version is 19, main routing table version 19
5 network entries using 600 bytes of memory
5 path entries using 260 bytes of memory
5/4 BGP path/bestpath attribute entries using 620 bytes of memory
1 BGP rrinfo entries using 24 bytes of memory
2 BGP AS-PATH entries using 48 bytes of memory
0 BGP route-map cache entries using 0 bytes of memory
0 BGP filter-list cache entries using 0 bytes of memory
Bitfield cache entries: current 1 (at peak 1) using 32 bytes of memory
BGP using 1584 total bytes of memory
BGP activity 5/0 prefixes, 10/5 paths, scan interval 60 secs

Neighbor      V    AS MsgRcvd MsgSent   TblVer  InQ  OutQ Up/Down
State/PfxRcd
1.1.1.1        4    10     35     28      19   0    0 00:10:28    4
R2#
```

Oke fix.

## BGP Attribute - Origin

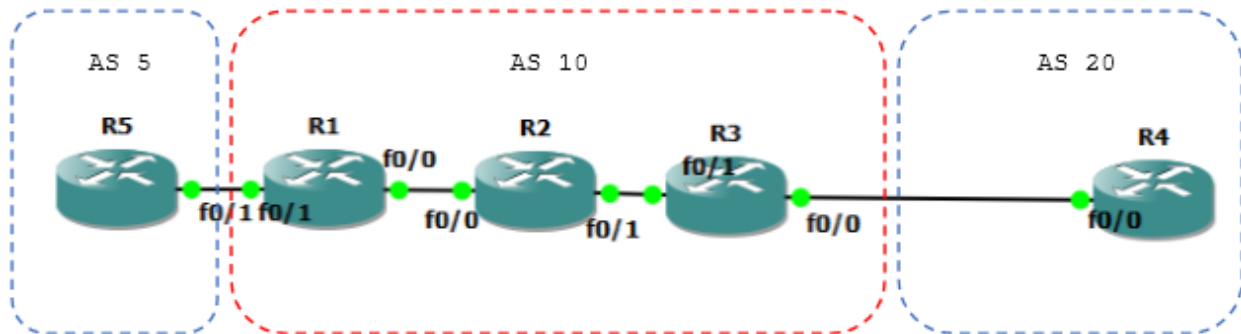

Buat interface loopback untuk didistributikan ke BGP.

```
R2(config)#int lo222
R2(config-if)#ip add 222.222.222.222 255.255.255.255
R2(config-if)#router rip
R2(config-router)#net 222.222.222.0
R2(config-router)#router bgp 10
R2(config-router)#redistribute rip

R5#sh ip bgp
BGP table version is 8, local router ID is 15.15.15.5
Status codes: s suppressed, d damped, h history, * valid, > best, i -
internal,
                r RIB-failure, S Stale
Origin codes: i - IGP, e - EGP, ? - incomplete

   Network          Next Hop          Metric LocPrf Weight Path
*> 11.11.11.11/32    15.15.15.1          0           0 10 i
*> 12.12.12.0/24    15.15.15.1          0           0 10 i
*> 15.15.15.0/24    0.0.0.0            0           32768 i
*> 22.22.22.22/32   15.15.15.1          0           0 10 i
*> 23.23.23.0/24    15.15.15.1          0           0 10 i
*> 44.44.44.44/32   15.15.15.1          0           0 10 20 i
*> 222.222.222.222/32 15.15.15.1          0           0 10 ?
R5#ping 222.222.222.222

Type escape sequence to abort.
Sending 5, 100-byte ICMP Echos to 222.222.222.222, timeout is 2 seconds:
!!!!
Success rate is 100 percent (5/5), round-trip min/avg/max = 32/80/108 ms
R5#
```

Pada path ada beberapa keterangan origin code:

**i** = berasal dari BGP baik iBGP atau eBGP dengan perintah network x.x.x.x mask X.X.X.X

**e** = berasal dari protocol EGP, saat ini sudah tidak ada.

**?** = berasal dari protocol lain(RIP, EIGRP, OSPF, Static) yang didistributikan ke BGP.

R5 menuju 222.222.222.222/32 melalui 15.15.15.1 dengan path 10 ? . Artinya Next AS Path nya adalah 200 dengan origin code adalah ? artinya terjadi melalui redistribute protocol lain ke BGP.

## BGP Attribute - Community

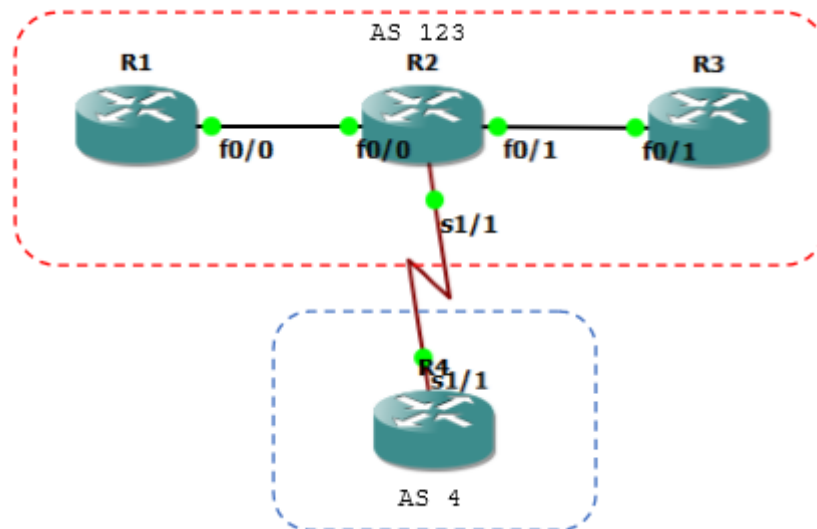

```
R1(config)#int lo0
R1(config-if)#ip add 1.1.1.1 255.255.255.255
R1(config-if)#int lo11
R1(config-if)#ip add 11.11.11.11 255.255.255.255
R1(config-if)#int fa0/0
R1(config-if)#ip add 12.12.12.1 255.255.255.0
R1(config-if)#router ospf 1
R1(config-router)#net 1.1.1.1 0.0.0.0 area 0
R1(config-router)#net 12.12.12.0 0.0.0.255 area 0
```

```
R2(config)#int lo0
R2(config-if)#ip add 2.2.2.2 255.255.255.255
R2(config-if)#int lo22
R2(config-if)#ip add 22.22.22.22 255.255.255.255
R2(config-if)#int fa0/0
R2(config-if)#no sh
R2(config-if)#ip add 12.12.12.2 255.255.255.0
R2(config-if)#int fa0/1
R2(config-if)#ip add 23.23.23.2 255.255.255.0
R2(config-if)#no sh
R2(config-if)#int s1/1
R2(config-if)#ip add 24.24.24.2 255.255.255.0
R2(config-if)#no sh
R2(config)#router ospf 1
R2(config-router)#net 2.2.2.2 0.0.0.0 area 0
R2(config-router)#net 12.12.12.0 0.0.0.255 area 0
R2(config-router)#net 24.24.24.0 0.0.0.255 area 0
```

```
R2(config-router)#net 23.23.23.0 0.0.0.255 area 0
```

```
R3(config)#int lo0
R3(config-if)#ip add 3.3.3.3 255.255.255.255
R3(config-if)#int lo33
R3(config-if)#ip add 33.33.33.33 255.255.255.255
R3(config-if)#int fa0/1
R3(config-if)#no sh
R3(config-if)#ip add 23.23.23.
R3(config-if)#ip add 23.23.23.3 255.255.255.0
R3(config-if)#router ospf 1
R3(config-router)#net 3.3.3.3 0.0.0.0 area 0
R3(config-router)#net 23.23.23.0 0.0.0.255 area 0
```

```
R4(config-if)#int lo0
R4(config-if)#ip add 4.4.4.4 255.255.255.255
R4(config-if)#int s1/1
R4(config-if)#ip add 24.24.24.24 255.255.255.0
R4(config-if)#no sh
```

## Konfigurasi BGP. R1 sebagai RR.

```
R1(config-router)#router bgp 123
R1(config-router)#neighbor 2.2.2.2 remote-as 123
R1(config-router)#neighbor 2.2.2.2 update-source loopback0
R1(config-router)#network 11.11.11.11 mask 255.255.255.255
```

```
R2(config-router)#router bgp 123
R2(config-router)#neighbor 1.1.1.1 remote-as 123
R2(config-router)#neighbor 3.3.3.3 remote-as 123
R2(config-router)#neighbor 24.24.24.4 remote-as 4
R2(config-router)#neighbor 1.1.1.1 update-source loopback 0
R2(config-router)#neighbor 3.3.3.3 update-source loopback 0
R2(config-router)#neighbor 1.1.1.1 route-reflector-client
R2(config-router)#neighbor 3.3.3.3 route-reflector-client
R2(config-router)#network 22.22.22.22 mask 255.255.255.255
```

```
R3(config)#router bgp 123
R3(config-router)#neighbor 2.2.2.2 remote-as 123
R3(config-router)#neighbor 2.2.2.2 up lo0
R3(config-router)#network 33.33.33.33 mask 255.255.255.255
```

```
R4(config-if)#router bgp 4
R4(config-router)#neighbor 24.24.24.2 remot 123
R4(config-router)#network 4.4.4.4 mask 255.255.255.255
```

## Sekarang cek bgp route di R1 dan R4.

```
R1#sh ip bgp
BGP table version is 4, local router ID is 11.11.11.11
Status codes: s suppressed, d damped, h history, * valid, > best, i -
internal,
                r RIB-failure, S Stale
Origin codes: i - IGP, e - EGP, ? - incomplete
```

Network	Next Hop	Metric	LocPrf	Weight	Path
* i4.4.4.4/32	24.24.24.4	0	100	0	4 i
*> 11.11.11.11/32	0.0.0.0	0		32768	i

```

*>i22.22.22.22/32  2.2.2.2          0    100    0 i
*>i33.33.33.33/32  3.3.3.3          0    100    0 i
R1#

R4#sh ip bgp
BGP table version is 5, local router ID is 4.4.4.4
Status codes: s suppressed, d damped, h history, * valid, > best, i -
internal,
              r RIB-failure, S Stale
Origin codes: i - IGP, e - EGP, ? - incomplete

   Network          Next Hop          Metric LocPrf Weight Path
*>  4.4.4.4/32      0.0.0.0           0             32768 i
*> 11.11.11.11/32   24.24.24.2        0             0 123 i
*> 22.22.22.22/32   24.24.24.2        0             0 123 i
*> 33.33.33.33/32   24.24.24.2        0             0 123 i
R4#

```

### Ada beberapa set-community dalam BGP:

**no-export** = network tidak diadvertise ke eBGP.

**no-advertise** = network tidak diadvertise ke iBGP/eBGP.

**local-as** = network hanya diadvertise ke iBGP Confederation(ada AS didalam AS).

### Set community no-export di R1.

```

R1(config)#access-list 10 permit host 11.11.11.11
R1(config)#route-map NO-EXPORT
R1(config-route-map)#match ip address ?
  <1-199>          IP access-list number
  <1300-2699>     IP access-list number (expanded range)
  WORD            IP access-list name
  prefix-list     Match entries of prefix-lists
  <cr>

R1(config-route-map)#match ip address 10
R1(config-route-map)#set community ?
  <1-4294967295> community number
  aa:nn          community number in aa:nn format
  additive       Add to the existing community
  internet       Internet (well-known community)
  local-AS       Do not send outside local AS (well-known community)
  no-advertise   Do not advertise to any peer (well-known community)
  no-export      Do not export to next AS (well-known community)
  none           No community attribute
  <cr>

R1(config-route-map)#set community no-export
R1(config-route-map)#router bgp 123
R1(config-router)#neighbor 2.2.2.2 route-map NO-EXPORT out
R1(config-router)#neighbor 2.2.2.2 send-community

```

### Cek bgp di R4 pastikan network 11.11.11.11 tidak ada.

```
R4#sh ip bgp
```



```

BGP table version is 6, local router ID is 4.4.4.4
Status codes: s suppressed, d damped, h history, * valid, > best, i -
internal,
                r RIB-failure, S Stale
Origin codes: i - IGP, e - EGP, ? - incomplete

```

Network	Next Hop	Metric	LocPrf	Weight	Path
*> 4.4.4.4/32	0.0.0.0	0		32768	i
*> 22.22.22.22/32	24.24.24.2	0		0	123 i
*> 33.33.33.33/32	24.24.24.2			0	123 i

R4#

```

R2#sh ip bgp 11.11.11.11
BGP routing table entry for 11.11.11.11/32, version 3
Paths: (1 available, best #1, table Default-IP-Routing-Table, not advertised
to EBGP peer)
Flag: 0x820
  Advertised to update-groups:
    2
  Local, (Received from a RR-client)
    1.1.1.1 (metric 11) from 1.1.1.1 (11.11.11.11)
      Origin IGP, metric 0, localpref 100, valid, internal, best
      Community: no-export
R2#

```

### Set community no-advertise di R3.

```

R3(config)#access-list 10 permit host 33.33.33.33
R3(config)#route-map NO-ADVERTISE
R3(config-route-map)#match ip address 10
R3(config-route-map)#set community no-advertise
R3(config-route-map)#router bgp 123
R3(config-router)#neighbor 2.2.2.2 route-map NO-ADVERTISE out
R3(config-router)#neighbor 2.2.2.2 send-community

```

### Cek di R1 dan R4 pastikan network 33.33.33.33 sudah tidak ada.

```

R1#sh ip bgp
BGP table version is 5, local router ID is 11.11.11.11
Status codes: s suppressed, d damped, h history, * valid, > best, i -
internal,
                r RIB-failure, S Stale
Origin codes: i - IGP, e - EGP, ? - incomplete

```

Network	Next Hop	Metric	LocPrf	Weight	Path
* i4.4.4.4/32	24.24.24.4	0	100		0 4 i
*> 11.11.11.11/32	0.0.0.0	0		32768	i
*>i22.22.22.22/32	2.2.2.2	0	100		0 i

R1#

```

R4#sh ip bgp
BGP table version is 7, local router ID is 4.4.4.4
Status codes: s suppressed, d damped, h history, * valid, > best, i -
internal,
                r RIB-failure, S Stale
Origin codes: i - IGP, e - EGP, ? - incomplete

```

Network	Next Hop	Metric	LocPrf	Weight	Path
---------	----------	--------	--------	--------	------

```

*> 4.4.4.4/32      0.0.0.0          0          32768 i
*> 22.22.22.22/32  24.24.24.2      0           0 123 i
R4#

R2#sh ip bgp 33.33.33.33
BGP routing table entry for 33.33.33.33/32, version 5
Paths: (1 available, best #1, table Default-IP-Routing-Table, not advertised
to any peer)
Flag: 0x820
    Not advertised to any peer
    Local, (Received from a RR-client)
    3.3.3.3 (metric 11) from 3.3.3.3 (33.33.33.33)
    Origin IGP, metric 0, localpref 100, valid, internal, best
    Community: no-advertise
R2#

```

Oke sip.

## BGP Attribute - Community Local-AS and Configuring Confederation

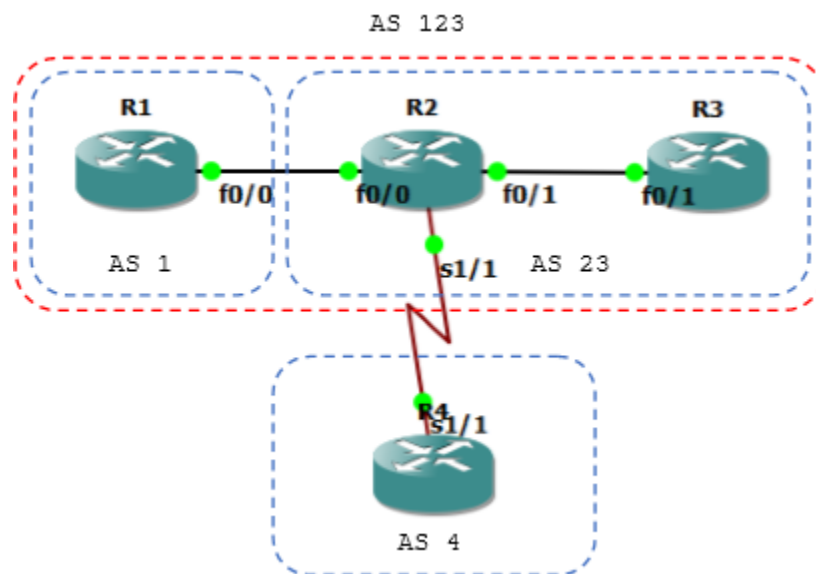

Oke konfigurasi BGP Confederation, sebelumnya hapus dulu BGP 123.

```

R1(config)#no router bgp 123
R1(config)#router bgp 1
R1(config-router)# bgp confederation identifier 123
R1(config-router)# bgp confederation peers 23
R1(config-router)# network 11.11.11.11 mask 255.255.255.255
R1(config-router)# neighbor 12.12.12.2 remote-as 23

R2(config)#no router bgp 123
R2(config)#router bgp 23
R2(config-router)# bgp confederation identifier 123
R2(config-router)# bgp confederation peers 1

```

```
R2(config-router)# network 22.22.22.22 mask 255.255.255.255
R2(config-router)# neighbor 12.12.12.1 remote-as 1
R2(config-router)# neighbor 12.12.12.1 next-hop-self
R2(config-router)# neighbor 23.23.23.3 remote-as 23
R2(config-router)# neighbor 23.23.23.3 next-hop-self
R2(config-router)# neighbor 24.24.24.4 remote-as 4
```

```
R3(config)#no router bgp 123
R3(config)#router bgp 23
R3(config-router)# bgp confederation identifier 123
R3(config-router)# network 33.33.33.33 mask 255.255.255.255
R3(config-router)# neighbor 23.23.23.2 remote-as 23
```

## Oke cek dulu.

```
R2(config-router)#do sh ip bgp sum
BGP router identifier 22.22.22.22, local AS number 23
BGP table version is 5, main routing table version 5
4 network entries using 480 bytes of memory
4 path entries using 208 bytes of memory
5/4 BGP path/bestpath attribute entries using 620 bytes of memory
2 BGP AS-PATH entries using 48 bytes of memory
0 BGP route-map cache entries using 0 bytes of memory
0 BGP filter-list cache entries using 0 bytes of memory
Bitfield cache entries: current 4 (at peak 4) using 128 bytes of memory
BGP using 1484 total bytes of memory
BGP activity 4/0 prefixes, 4/0 paths, scan interval 60 secs
```

Neighbor	V	AS	MsgRcvd	MsgSent	TblVer	InQ	OutQ	Up/Down	
12.12.12.1	4	1	6	8	5	0	0	00:02:13	1
23.23.23.3	4	23	6	8	5	0	0	00:02:03	1
24.24.24.4	4	4	7	9	5	0	0	00:02:08	1

```
R2(config-router)#do sh ip bgp
BGP table version is 5, local router ID is 22.22.22.22
Status codes: s suppressed, d damped, h history, * valid, > best, i -
internal,
                r RIB-failure, S Stale
Origin codes: i - IGP, e - EGP, ? - incomplete
```

Network	Next Hop	Metric	LocPrf	Weight	Path
*> 4.4.4.4/32	24.24.24.4	0		0	4 i
*> 11.11.11.11/32	12.12.12.1	0	100	0	(1) i
*> 22.22.22.22/32	0.0.0.0	0		32768	i
*>i33.33.33.33/32	23.23.23.3	0	100	0	i

```
R2(config-router)#
```

```
R1(config-router)#do sh ip bgp
BGP table version is 5, local router ID is 11.11.11.11
Status codes: s suppressed, d damped, h history, * valid, > best, i -
internal,
                r RIB-failure, S Stale
Origin codes: i - IGP, e - EGP, ? - incomplete
```

Network	Next Hop	Metric	LocPrf	Weight	Path
*> 4.4.4.4/32	12.12.12.2	0	100	0	(23) 4 i
*> 11.11.11.11/32	0.0.0.0	0		32768	i

```
*> 22.22.22.22/32 12.12.12.2 0 100 0 (23) i
*> 33.33.33.33/32 12.12.12.2 0 100 0 (23) i
R1(config-router)#
```

### Sekarang set community local-as pada R3.

```
R3(config)#access-list 20 permit host 33.33.33.33
R3(config)#route-map LOCAL-AS
R3(config-route-map)#match ip address 20
R3(config-route-map)#set community local-AS
R3(config-route-map)#router bgp 23
R3(config-router)#neighbor 23.23.23.2 route-map LOCAL-AS out
R3(config-router)#neighbor 23.23.23.2 send-community
```

### Cek di R1 dan R2. Harusnya network 33.33.33.33 hanya diadvertise ke Confederation iBGP(R2) saja.

```
R1#sh ip bgp
BGP table version is 4, local router ID is 11.11.11.11
Status codes: s suppressed, d damped, h history, * valid, > best, i -
internal,
                r RIB-failure, S Stale
Origin codes: i - IGP, e - EGP, ? - incomplete

   Network          Next Hop          Metric LocPrf Weight Path
*> 4.4.4.4/32       12.12.12.2         0      100      0 (23) 4 i
*> 11.11.11.11/32   0.0.0.0            0              32768 i
*> 22.22.22.22/32   12.12.12.2         0      100      0 (23) i
R1#
```

```
R2#sh ip bgp
BGP table version is 5, local router ID is 22.22.22.22
Status codes: s suppressed, d damped, h history, * valid, > best, i -
internal,
                r RIB-failure, S Stale
Origin codes: i - IGP, e - EGP, ? - incomplete

   Network          Next Hop          Metric LocPrf Weight Path
*> 4.4.4.4/32       24.24.24.4         0              0 4 i
*> 11.11.11.11/32   12.12.12.1         0      100      0 (1) i
*> 22.22.22.22/32   0.0.0.0            0              32768 i
*>i33.33.33.33/32   23.23.23.3         0      100      0 i
R2#sh ip bgp 33.33.33.33
BGP routing table entry for 33.33.33.33/32, version 4
Paths: (1 available, best #1, table Default-IP-Routing-Table, not advertised
outside local AS)
  Not advertised to any peer
  Local
    23.23.23.3 from 23.23.23.3 (33.33.33.33)
      Origin IGP, metric 0, localpref 100, valid, confed-internal, best
      Community: local-AS
R2#
```

# BGP Aggregator

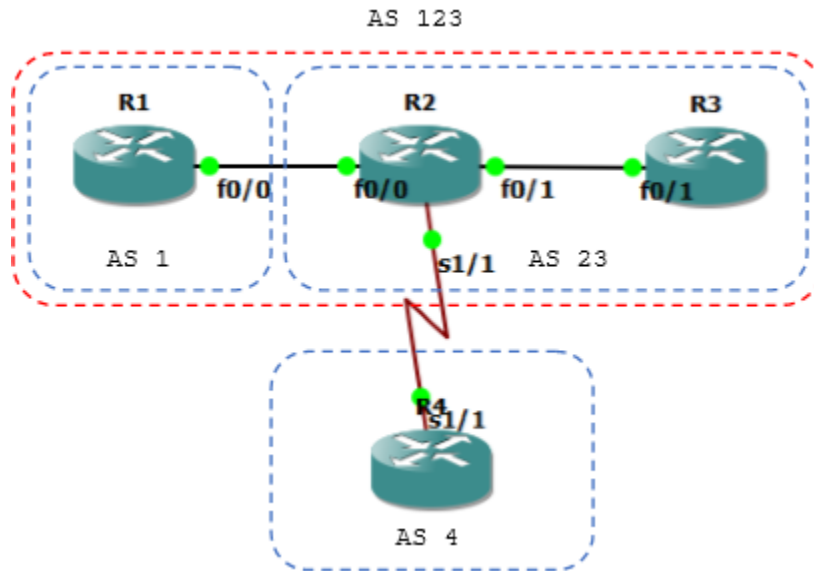

Aggregator ini sama dengan summary.

```
R4(config)#int lo1
R4(config-if)#ip add 44.1.1.1 255.255.255.255
R4(config-if)#int lo2
R4(config-if)#ip add 44.2.1.1 255.255.255.255
R4(config-if)#int lo3
R4(config-if)#ip add 44.3.1.1 255.255.255.255
R4(config-if)#int lo4
R4(config-if)#ip add 44.4.1.1 255.255.255.255
R4(config-if)#int lo5
R4(config-if)#ip add 44.5.1.1 255.255.255.255
R4(config-if)#int lo6
R4(config-if)#ip add 44.6.1.1 255.255.255.255
```

Advertise ke BGP.

```
R4(config-if)#router bgp 4
R4(config-router)#network 44.1.1.1 mask 255.255.255.255
R4(config-router)#network 44.2.1.1 mask 255.255.255.255
R4(config-router)#network 44.3.1.1 mask 255.255.255.255
R4(config-router)#network 44.4.1.1 mask 255.255.255.255
R4(config-router)#network 44.5.1.1 mask 255.255.255.255
R4(config-router)#network 44.6.1.1 mask 255.255.255.255
```

Cek di R1.

```
R1#sh ip bgp
BGP table version is 10, local router ID is 11.11.11.11
Status codes: s suppressed, d damped, h history, * valid, > best, i -
internal,
                r RIB-failure, S Stale
Origin codes: i - IGP, e - EGP, ? - incomplete

   Network          Next Hop          Metric LocPrf Weight Path
*> 4.4.4.4/32       12.12.12.2         0      100      0 (23) 4 i
```

```

*> 11.11.11.11/32 0.0.0.0 0 32768 i
*> 22.22.22.22/32 12.12.12.2 0 100 0 (23) i
*> 44.1.1.1/32 12.12.12.2 0 100 0 (23) 4 i
*> 44.2.1.1/32 12.12.12.2 0 100 0 (23) 4 i
*> 44.3.1.1/32 12.12.12.2 0 100 0 (23) 4 i
*> 44.4.1.1/32 12.12.12.2 0 100 0 (23) 4 i
*> 44.5.1.1/32 12.12.12.2 0 100 0 (23) 4 i
*> 44.6.1.1/32 12.12.12.2 0 100 0 (23) 4 i
R1#

```

## Lakukan aggregate di R4 lalu cek kembali di R1.

```

R4(config-router)#aggregate-address 44.0.0.0 255.248.0.0

R1#sh ip bgp
BGP table version is 11, local router ID is 11.11.11.11
Status codes: s suppressed, d damped, h history, * valid, > best, i -
internal,
                r RIB-failure, S Stale
Origin codes: i - IGP, e - EGP, ? - incomplete

   Network          Next Hop          Metric LocPrf Weight Path
*> 4.4.4.4/32       12.12.12.2         0     100     0 (23) 4 i
*> 11.11.11.11/32  0.0.0.0            0           32768 i
*> 22.22.22.22/32  12.12.12.2         0     100     0 (23) i
*> 44.0.0.0/13     12.12.12.2         0     100     0 (23) 4 i
*> 44.1.1.1/32     12.12.12.2         0     100     0 (23) 4 i
*> 44.2.1.1/32     12.12.12.2         0     100     0 (23) 4 i
*> 44.3.1.1/32     12.12.12.2         0     100     0 (23) 4 i
*> 44.4.1.1/32     12.12.12.2         0     100     0 (23) 4 i
*> 44.5.1.1/32     12.12.12.2         0     100     0 (23) 4 i
*> 44.6.1.1/32     12.12.12.2         0     100     0 (23) 4 i
R1#sh ip bgp 44.0.0.0
BGP routing table entry for 44.0.0.0/13, version 11
Paths: (1 available, best #1, table Default-IP-Routing-Table)
Flag: 0x820
    Not advertised to any peer
    (23) 4, (aggregated by 4 4.4.4.4)
    12.12.12.2 from 12.12.12.2 (22.22.22.22)
    Origin IGP, metric 0, localpref 100, valid, confed-external, atomic-
aggregate, best
R1#

```

## Aggregate single route.

```

R4(config-router)#aggregate-address 44.0.0.0 255.248.0.0 summary-only

R1#sh ip bgp
BGP table version is 17, local router ID is 11.11.11.11
Status codes: s suppressed, d damped, h history, * valid, > best, i -
internal,
                r RIB-failure, S Stale
Origin codes: i - IGP, e - EGP, ? - incomplete

   Network          Next Hop          Metric LocPrf Weight Path
*> 4.4.4.4/32       12.12.12.2         0     100     0 (23) 4 i
*> 11.11.11.11/32  0.0.0.0            0           32768 i

```

```
*> 22.22.22.22/32 12.12.12.2 0 100 0 (23) i
*> 44.0.0.0/13 12.12.12.2 0 100 0 (23) 4 i
R1#
```

## Aggregate suppress map.

```
R4(config)#access-list 1 permit host 44.1.1.1
R4(config)#access-list 1 permit host 44.2.1.1
R4(config)#access-list 1 permit host 44.3.1.1
R4(config)#access-list 1 deny any
R4(config)#route-map BLOK
R4(config-route-map)#match ip address 1
R4(config-route-map)#router bgp 4
R4(config-router)#aggregate-address 44.0.0.0 255.248.0.0 suppress-map BLOK
R4(config-router)#do sh bgp
BGP table version is 26, local router ID is 4.4.4.4
Status codes: s suppressed, d damped, h history, * valid, > best, i -
internal,
                r RIB-failure, S Stale
Origin codes: i - IGP, e - EGP, ? - incomplete
```

Network	Next Hop	Metric	LocPrf	Weight	Path
*> 4.4.4.4/32	0.0.0.0	0		32768	i
*> 11.11.11.11/32	24.24.24.2			0	123 i
*> 22.22.22.22/32	24.24.24.2	0		0	123 i
*> 44.0.0.0/13	0.0.0.0			32768	i
s> 44.1.1.1/32	0.0.0.0	0		32768	i
s> 44.2.1.1/32	0.0.0.0	0		32768	i
s> 44.3.1.1/32	0.0.0.0	0		32768	i
*> 44.4.1.1/32	0.0.0.0	0		32768	i
*> 44.5.1.1/32	0.0.0.0	0		32768	i
*> 44.6.1.1/32	0.0.0.0	0		32768	i

R4(config-router)#

## Cek di R1.

```
R1#sh ip bgp
BGP table version is 26, local router ID is 11.11.11.11
Status codes: s suppressed, d damped, h history, * valid, > best, i -
internal,
                r RIB-failure, S Stale
Origin codes: i - IGP, e - EGP, ? - incomplete
```

Network	Next Hop	Metric	LocPrf	Weight	Path
*> 4.4.4.4/32	12.12.12.2	0	100	0	(23) 4 i
*> 11.11.11.11/32	0.0.0.0	0		32768	i
*> 22.22.22.22/32	12.12.12.2	0	100	0	(23) i
*> 44.0.0.0/13	12.12.12.2	0	100	0	(23) 4 i
*> 44.4.1.1/32	12.12.12.2	0	100	0	(23) 4 i
*> 44.5.1.1/32	12.12.12.2	0	100	0	(23) 4 i
*> 44.6.1.1/32	12.12.12.2	0	100	0	(23) 4 i

R1#

## Oke sip.

## BGP Attribute - Weight

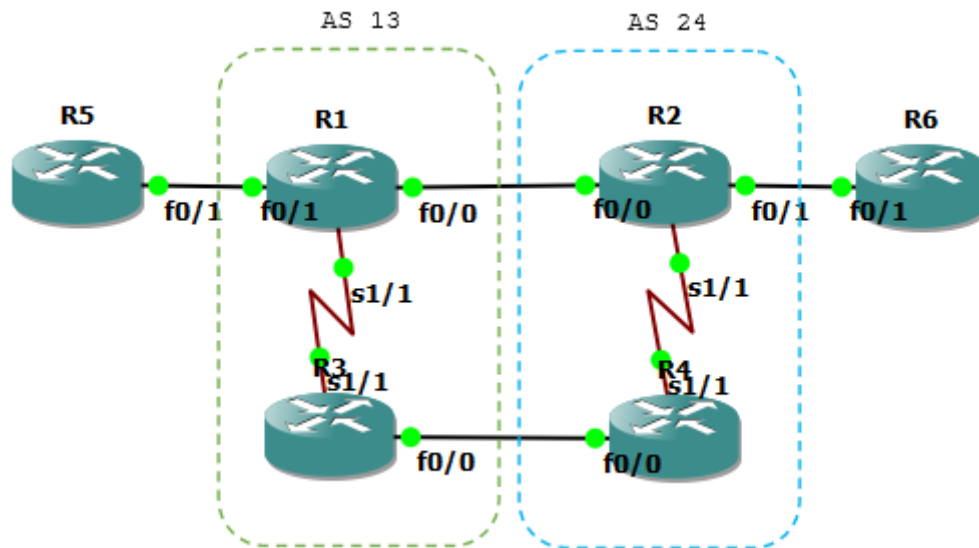

```
R1(config)#int fa0/0
R1(config-if)#ip add 12.12.12.1 255.255.255.0
R1(config-if)#no sh
R1(config-if)#int fa0/1
R1(config-if)#ip add 15.15.15.1 255.255.255.0
R1(config-if)#no sh
R1(config-if)#int s1/1
R1(config-if)#ip add 13.13.13.1 255.255.255.0
R1(config-if)#no sh
```

```
R2(config)#int fa0/0
R2(config-if)#ip add 12.12.12.2 255.255.255.0
R2(config-if)#no sh
R2(config-if)#int s1/1
R2(config-if)#ip add 24.24.24.2 255.255.255.0
R2(config-if)#no sh
R2(config-if)#int fa0/1
R2(config-if)#ip add 26.26.26.2 255.255.255.0
R2(config-if)#no sh
```

```
R3(config)#int fa0/0
R3(config-if)#ip add 34.34.34.3 255.255.255.0
R3(config-if)#no sh
R3(config-if)#int s1/1
R3(config-if)#ip add 13.13.13.3 255.255.255.0
R3(config-if)#no sh
```

```
R4(config)#int fa0/0
R4(config-if)#ip add 34.34.34.4 255.255.255.0
R4(config-if)#no sh
R4(config-if)#int s1/1
R4(config-if)#ip add 24.24.24.4 255.255.255.0
R4(config-if)#no sh
```

```
R5(config)#int fa0/1
```



```
R5(config-if)#ip add 15.15.15.5 255.255.255.0
R5(config-if)#no sh
```

```
R6(config)#int fa0/1
R6(config-if)#ip add 26.26.26.6 255.255.255.0
R6(config-if)#no sh
```

## Konfigurasi BGP.

```
R1(config)#router bgp 13
R1(config-router)# neighbor 12.12.12.2 remote-as 24
R1(config-router)# neighbor 12.12.12.2 next-hop-self
R1(config-router)# neighbor 13.13.13.3 remote-as 13
R1(config-router)# neighbor 13.13.13.3 next-hop-self
```

```
R3(config-router)#router bgp 13
R3(config-router)# neighbor 13.13.13.1 remote-as 13
R3(config-router)# neighbor 13.13.13.1 next-hop-self
R3(config-router)# neighbor 34.34.34.4 remote-as 24
R3(config-router)# neighbor 34.34.34.4 next-hop-self
```

```
R2(config)#router bgp 24
R2(config-router)# neighbor 12.12.12.1 remote-as 13
R2(config-router)# neighbor 12.12.12.1 next-hop-self
R2(config-router)# neighbor 24.24.24.4 remote-as 24
R2(config-router)# neighbor 24.24.24.4 next-hop-self
```

```
R4(config-if)#router bgp 24
R4(config-router)# network 45.45.45.0 mask 255.255.255.0
R4(config-router)# neighbor 24.24.24.2 remote-as 24
R4(config-router)# neighbor 34.34.34.3 remote-as 13
R4(config-router)# neighbor 24.24.24.2 next-hop-self
R4(config-router)# neighbor 34.34.34.3 next-hop-self
```

## Default route pada R5 dan R6. Advertise dulu network R2 ke BGP.

```
R1(config-router)#network 15.15.15.0 mask 255.255.255.0
R2(config-router)# network 26.26.26.0 mask 255.255.255.0
```

```
R1(config-router)#do sh ip bgp
BGP table version is 8, local router ID is 15.15.15.1
Status codes: s suppressed, d damped, h history, * valid, > best, i -
internal,
                r RIB-failure, S Stale
Origin codes: i - IGP, e - EGP, ? - incomplete
```

Network	Next Hop	Metric	LocPrf	Weight	Path
*> 15.15.15.0/24	0.0.0.0	0		32768	i
* i26.26.26.0/24	13.13.13.3	0	100	0	24 i
*>	12.12.12.2	0		100	24 i

```
R1(config-router)#do sh ip bgp 26.26.26.0
BGP routing table entry for 26.26.26.0/24, version 2
Paths: (2 available, best #2, table Default-IP-Routing-Table)
  Advertised to update-groups:
    2
  24
    12.12.12.2 from 12.12.12.2 (26.26.26.2)
      Origin IGP, metric 0, localpref 100, valid, external
```

```
24
 13.13.13.3 from 13.13.13.3 (34.34.34.3)
   Origin IGP, metric 0, localpref 100, valid, internal, best
R1(config-router)#
```

Ternyata ada 2 jalur menuju network 26.26.26.0, namun yang digunakan sekarang adalah melalui 12.12.12.2. Sekarang masukkan default routing ke R5 dan R6.

```
R5(config-if)#ip route 0.0.0.0 0.0.0.0 15.15.15.1
R6(config-if)#ip route 0.0.0.0 0.0.0.0 26.26.26.2
```

Trace dari R5 ke R6.

```
R5#trace 26.26.26.6

Type escape sequence to abort.
Tracing the route to 26.26.26.6

 0 15.15.15.1 68 msec 96 msec 68 msec
 1 12.12.12.2 88 msec 76 msec 80 msec
 2 26.26.26.6 200 msec 148 msec 56 msec
R5#
```

Sekarang kita belokkan jalurnya agar melalui 13.13.13.3 dengan konfigurasi weight attribute.

```
R1(config)#route-map WEIGHT permit 10
R1(config-route-map)#set weight 100
R1(config-route-map)#router bgp 13
R1(config-router)#neighbor 13.13.13.3 route-map WEIGHT in
R1(config-router)#do clear ip bgp *
```

Sekarang kita cek lagi.

```
R1(config-router)#do sh ip bgp 26.26.26.0
BGP routing table entry for 26.26.26.0/24, version 2
Paths: (2 available, best #2, table Default-IP-Routing-Table)
  Advertised to update-groups:
    2
 24
 12.12.12.2 from 12.12.12.2 (26.26.26.2)
   Origin IGP, metric 0, localpref 100, valid, external
 24
 13.13.13.3 from 13.13.13.3 (34.34.34.3)
   Origin IGP, metric 0, localpref 100, weight 100, valid, internal, best
R1(config-router)#

R5#trace 26.26.26.6

Type escape sequence to abort.
Tracing the route to 26.26.26.6

 0 15.15.15.1 112 msec 72 msec 60 msec
 1 13.13.13.3 140 msec 112 msec 88 msec
 2 34.34.34.4 232 msec 172 msec 88 msec
 3 24.24.24.2 112 msec 140 msec 156 msec
 4 26.26.26.6 220 msec 240 msec 152 msec
R5#
```

## BGP Dualhoming – Load Balance

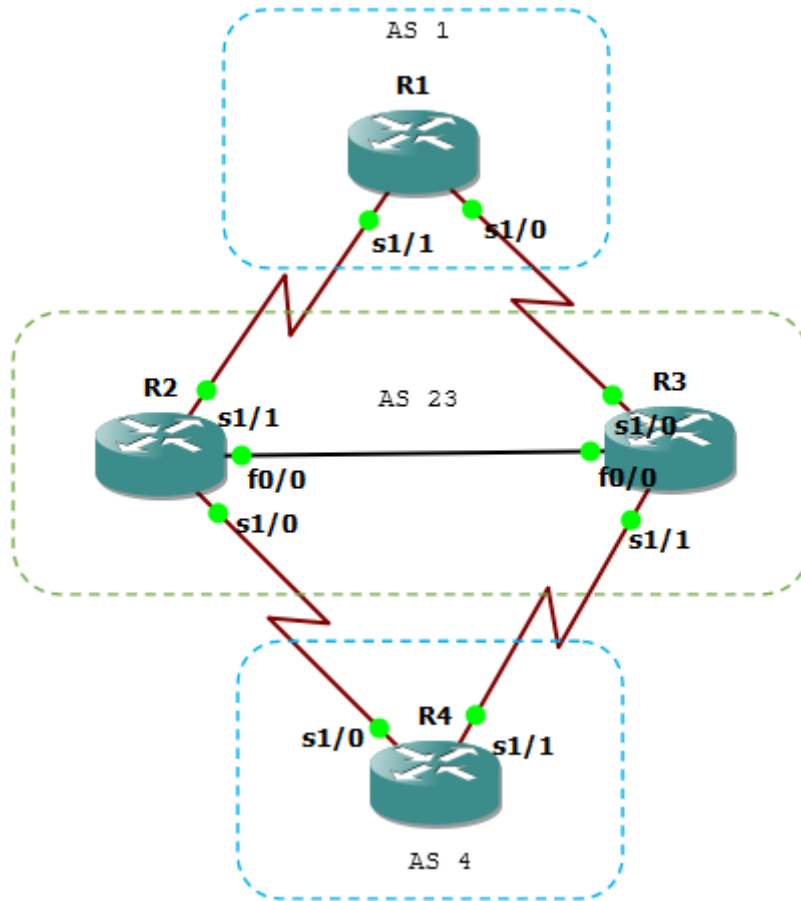

### Konfigurasi interface.

```
R1(config)#int s1/1
R1(config-if)#ip add 12.12.12.1 255.255.255.0
R1(config-if)#no sh
R1(config-if)#int s1/0
R1(config-if)#ip add 13.13.13.1 255.255.255.0
R1(config-if)#no sh
```

```
R2(config)#int s1/1
R2(config-if)#ip add 12.12.12.2 255.255.255.0
R2(config-if)#no sh
R2(config-if)#int s1/0
R2(config-if)#ip add 24.24.24.2 255.255.255.0
R2(config-if)#no sh
R2(config-if)#int fa0/0
R2(config-if)#ip add 23.23.23.2 255.255.255.0
R2(config-if)#no sh
```

```
R3(config)#int s1/1
R3(config-if)#ip add 34.34.34.3 255.255.255.0
R3(config-if)#no sh
R3(config-if)#int s1/0
R3(config-if)#ip add 13.13.13.3 255.255.255.0
```

```
R3(config-if)#no sh
R3(config-if)#int fa0/0
R3(config-if)#ip add 23.23.23.3 255.255.255.0
R3(config-if)#no sh
```

```
R4(config)#int s1/1
R4(config-if)#ip add 34.34.34.4 255.255.255.0
R4(config-if)#no sh
R4(config-if)#int s1/0
R4(config-if)#ip add 24.24.24.4 255.255.255.0
R4(config-if)#no sh
```

## Konfigurasi BGP.

```
R1(config)#router bgp 1
R1(config-router)#neighbor 12.12.12.2 remote-as 23
R1(config-router)#neighbor 13.13.13.3 remote-as 23
```

```
R2(config)#router bgp 23
R2(config-router)#neighbor 12.12.12.1 remote-as 1
R2(config-router)#neighbor 24.24.24.4 remote-as 4
R2(config-router)#neighbor 23.23.23.3 remote-as 23
R2(config-router)#neighbor 23.23.23.3 next-hop-self
```

```
R3(config)#router bgp 23
R3(config-router)#neighbor 34.34.34.4 remote-as 4
R3(config-router)#neighbor 13.13.13.1 remote-as 1
R3(config-router)#neighbor 23.23.23.2 remote-as 23
R2(config-router)#neighbor 23.23.23.2 next-hop-self
```

```
R4(config)#router bgp 4
R4(config-router)#neighbor 24.24.24.2 remote-as 23
R4(config-router)#neighbor 34.34.34.3 remote-as 23
```

## Buat loopback di R1 dan R4 lalu advertise ke BGP..

```
R1(config)#int lo0
R1(config-if)#ip add 1.1.1.1 255.255.255.255
R1(config-if)#router bgp 1
R1(config-router)#network 1.1.1.1 mask 255.255.255.255
```

```
R4(config)#int lo0
R4(config-if)#ip add 4.4.4.4 255.255.255.255
R4(config-if)#router bgp 4
R4(config-router)#net 4.4.4.4 mask 255.255.255.255
```

```
R1(config-router)#do sh ip bgp
BGP table version is 15, local router ID is 1.1.1.1
Status codes: s suppressed, d damped, h history, * valid, > best, i -
internal,
                r RIB-failure, S Stale
Origin codes: i - IGP, e - EGP, ? - incomplete
```

Network	Next Hop	Metric	LocPrf	Weight	Path
*> 1.1.1.1/32	0.0.0.0	0		32768	i
*> 4.4.4.4/32	12.12.12.2			100	23 4 i
*	13.13.13.3			0	23 4 i

Walau ada 2 link, yang dipakai hanya 1, dilihat dari tanda “>” nya hanya satu. Informasi diatas menunjukkan yang dipakai sebagai next hop ke 4.4.4.4 adalah 12.12.12.2.

Coba ping dari R1 ke R4.

```
R1(config-router)#do ping 4.4.4.4

Type escape sequence to abort.
Sending 5, 100-byte ICMP Echos to 4.4.4.4, timeout is 2 seconds:
.....
Success rate is 0 percent (0/5)
R1(config-router)#do trace 4.4.4.4

Type escape sequence to abort.
Tracing the route to 4.4.4.4

  1 12.12.12.2 84 msec 60 msec 64 msec
  2 * * *
  3 *
R1(config)#
```

Ternyata gagal. Hal ini dikarenakan network belum diadvertise ke BGP.

```
R1(config-router)#network 12.12.12.0 mask 255.255.255.0
R1(config-router)#network 13.13.13.0 mask 255.255.255.0

R4(config-router)#network 24.24.24.0 mask 255.255.255.0
R4(config-router)#network 34.34.34.0 mask 255.255.255.0
```

Oke cek lagi.

```
R1(config-router)#do ping 4.4.4.4

Type escape sequence to abort.
Sending 5, 100-byte ICMP Echos to 4.4.4.4, timeout is 2 seconds:
!!!!
Success rate is 100 percent (5/5), round-trip min/avg/max = 44/88/152 ms
R1(config-router)#do trace 4.4.4.4

Type escape sequence to abort.
Tracing the route to 4.4.4.4

  1 12.12.12.2 52 msec 44 msec 32 msec
  2 24.24.24.4 [AS 4] 96 msec 108 msec 64 msec
R1(config-router)#
```

Sekarang konfigurasikan agar load-balance.

```
R1(config-router)#maximum-paths 2

R1(config-router)#do sh ip bgp
BGP table version is 21, local router ID is 1.1.1.1
Status codes: s suppressed, d damped, h history, * valid, > best, i -
internal,
                r RIB-failure, S Stale
Origin codes: i - IGP, e - EGP, ? - incomplete

Network          Next Hop          Metric LocPrf Weight Path
```

```

*> 1.1.1.1/32      0.0.0.0      0      32768 i
*> 4.4.4.4/32      12.12.12.2   0      100 23 4 i
*                  13.13.13.3   0      0 23 4 i
*> 12.12.12.0/24   0.0.0.0      0      32768 i
*> 13.13.13.0/24   0.0.0.0      0      32768 i
*> 24.24.24.0/24   12.12.12.2   0      100 23 4 i
*                  13.13.13.3   0      0 23 4 i
*> 34.34.34.0/24   12.12.12.2   0      100 23 4 i
*                  13.13.13.3   0      0 23 4 i
R1(config-router)#do trace 4.4.4.4

Type escape sequence to abort.
Tracing the route to 4.4.4.4

  1 13.13.13.3 80 msec
    12.12.12.2 64 msec
    13.13.13.3 60 msec
  2 24.24.24.4 [AS 4] 188 msec
    34.34.34.4 [AS 4] 152 msec
    24.24.24.4 [AS 4] 168 msec
R1(config-router)#

```

Walau pada show ip bgp tanda ">" hanya 1, tapi ketika dicek sudah load balance.  
Oke sip.

## BGP Dualhoming – Set Weight

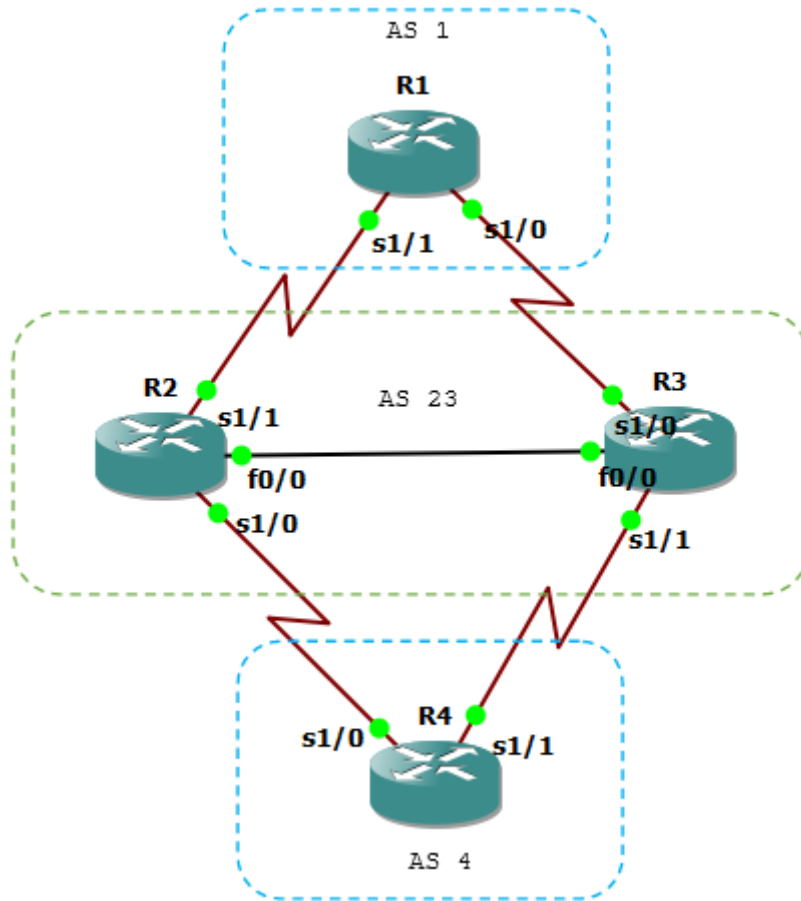

Oke hapus dulu konfigurasi load balancenya.

```
R1(config)#router bgp 1
R1(config-router)#no maximum-paths 2
```

Sekarang coba ping ke 4.4.4.4.

```
R1#sh ip bgp
BGP table version is 8, local router ID is 1.1.1.1
Status codes: s suppressed, d damped, h history, * valid, > best, i -
internal,
              r RIB-failure, S Stale
Origin codes: i - IGP, e - EGP, ? - incomplete
```

Network	Next Hop	Metric	LocPrf	Weight	Path
*> 1.1.1.1/32	0.0.0.0	0		32768	i
*> 4.4.4.4/32	12.12.12.2			0	23 4 i
*	13.13.13.3			0	23 4 i
*> 12.12.12.0/24	0.0.0.0	0		32768	i
*> 13.13.13.0/24	0.0.0.0	0		32768	i
* 23.23.23.0/24	12.12.12.2	0		0	23 i
*>	13.13.13.3	0		0	23 i
* 24.24.24.0/24	12.12.12.2			0	23 4 i
*>	13.13.13.3			0	23 4 i
* 34.34.34.0/24	12.12.12.2			0	23 4 i

```

*> 13.13.13.3 0 23 4 i
R1#trace 4.4.4.4

Type escape sequence to abort.
Tracing the route to 4.4.4.4

 1 12.12.12.2 40 msec 108 msec 60 msec
 2 24.24.24.4 [AS 4] 88 msec 100 msec 96 msec
R1#

```

Untuk menuju 4.4.4.4, melewati 12.12.12.2. Sekarang coba matikan interface 12.12.12.1.

```

R1(config-if)#int s1/1
R1(config-if)#shutdown
*Mar 1 00:07:37.387: %BGP-5-ADJCHANGE: neighbor 12.12.12.2 Down Interface flap

R1(config-if)#do sh ip bgp
BGP table version is 23, local router ID is 1.1.1.1
Status codes: s suppressed, d damped, h history, * valid, > best, i -
internal,
                r RIB-failure, S Stale
Origin codes: i - IGP, e - EGP, ? - incomplete

   Network          Next Hop          Metric LocPrf Weight Path
*> 1.1.1.1/32       0.0.0.0           0         32768 i
*> 4.4.4.4/32       13.13.13.3        0         0 23 4 i
*> 13.13.13.0/24    0.0.0.0           0         32768 i
*> 23.23.23.0/24    13.13.13.3        0         0 23 i
*> 24.24.24.0/24    13.13.13.3        0         0 23 4 i
*> 34.34.34.0/24    13.13.13.3        0         0 23 4 i
R1(config-if)#

```

Maka sekarang akan untuk menuju 4.4.4.4 akan melewati 13.13.13.3. Coba hidupkan interface nya lagi. Ternyata walau sudah dihidupkan, main link nya tidak kembali ke 12.12.12.2 tapi tetap menggunakan 13.13.13.3.

```

R1(config-if)#int s1/1
R1(config-if)#no sh
R1(config-if)#do sh ip bgp
BGP table version is 24, local router ID is 1.1.1.1
Status codes: s suppressed, d damped, h history, * valid, > best, i -
internal,
                r RIB-failure, S Stale
Origin codes: i - IGP, e - EGP, ? - incomplete

   Network          Next Hop          Metric LocPrf Weight Path
*> 1.1.1.1/32       0.0.0.0           0         32768 i
* 4.4.4.4/32       12.12.12.2        0         0 23 4 i
*> 4.4.4.4/32       13.13.13.3        0         0 23 4 i
*> 12.12.12.0/24    0.0.0.0           0         32768 i
*> 13.13.13.0/24    0.0.0.0           0         32768 i
* 23.23.23.0/24    12.12.12.2        0         0 23 i
*> 23.23.23.0/24    13.13.13.3        0         0 23 i
* 24.24.24.0/24    12.12.12.2        0         0 23 4 i
*> 24.24.24.0/24    13.13.13.3        0         0 23 4 i

```



```

* 34.34.34.0/24 12.12.12.2 0 23 4 i
*> 13.13.13.3 0 23 4 i
R1(config-if)#

```

Untuk mengatasinya, konfigurasi attribute weight.

```

R1(config)#route-map WEIGHT
R1(config-route-map)#set ?
  as-path          Prepend string for a BGP AS-path attribute
  automatic-tag    Automatically compute TAG value
  clns             OSI summary address
  comm-list        set BGP community list (for deletion)
  community        BGP community attribute
  dampening        Set BGP route flap dampening parameters
  default          Set default information
  extcommunity     BGP extended community attribute
  interface        Output interface
  ip               IP specific information
  ipv6             IPv6 specific information
  level           Where to import route
  local-preference BGP local preference path attribute
  metric           Metric value for destination routing protocol
  metric-type      Type of metric for destination routing protocol
  mpls-label       Set MPLS label for prefix
  origin           BGP origin code
  tag              Tag value for destination routing protocol
  traffic-index    BGP traffic classification number for accounting
  vrf              Define VRF name
  weight           BGP weight for routing table

```

```

R1(config-route-map)#set weight 100
R1(config-route-map)#router bgp 1
R1(config-router)#nei
R1(config-router)#neighbor 12.12.12.2 route-map WEIGHT in
R1(config-router)#do clear ip bgp *

```

```

R1(config-router)#do sh ip bgp
BGP table version is 5, local router ID is 1.1.1.1
Status codes: s suppressed, d damped, h history, * valid, > best, i -
internal,
                r RIB-failure, S Stale
Origin codes: i - IGP, e - EGP, ? - incomplete

```

	Network	Next Hop	Metric	LocPrf	Weight	Path
*	4.4.4.4/32	13.13.13.3			0	23 4 i
*>		12.12.12.2			100	23 4 i
*	23.23.23.0/24	13.13.13.3	0		0	23 i
*>		12.12.12.2	0		100	23 i
*	24.24.24.0/24	13.13.13.3			0	23 4 i
*>		12.12.12.2			100	23 4 i
*	34.34.34.0/24	13.13.13.3			0	23 4 i
*>		12.12.12.2			100	23 4 i

```

R1(config-router)#

```

Sip dah. Klo gak percaya kita tes lagi.

```

R1(config-router)#int s1/1

```

```

R1(config-if)#sh
*Mar 1 00:15:25.867: %BGP-5-ADJCHANGE: neighbor 12.12.12.2 Down Interface
flap
R1(config-if)#
*Mar 1 00:15:27.827: %LINK-5-CHANGED: Interface Serial1/1, changed state to
administratively down
*Mar 1 00:15:28.827: %LINEPROTO-5-UPDOWN: Line protocol on Interface
Serial1/1, changed state to down
R1(config-if)#do sh ip bgp
BGP table version is 13, local router ID is 1.1.1.1
Status codes: s suppressed, d damped, h history, * valid, > best, i -
internal,
                r RIB-failure, S Stale
Origin codes: i - IGP, e - EGP, ? - incomplete

   Network          Next Hop          Metric LocPrf Weight Path
*> 1.1.1.1/32       0.0.0.0            0         32768 i
*> 4.4.4.4/32       13.13.13.3         0          0 23 4 i
*> 13.13.13.0/24    0.0.0.0            0         32768 i
*> 23.23.23.0/24    13.13.13.3         0          0 23 i
*> 24.24.24.0/24    13.13.13.3         0          0 23 4 i
*> 34.34.34.0/24    13.13.13.3         0          0 23 4 i
R1(config-if)#

```

**Sekarang hidupin lagi. Tunggu agak lama baru cek show ip bgp.**

```

R1(config-if)#no sh
R1(config-if)#
*Mar 1 00:15:52.047: %LINK-3-UPDOWN: Interface Serial1/1, changed state to
up
R1(config-if)#
*Mar 1 00:15:53.051: %LINEPROTO-5-UPDOWN: Line protocol on Interface
Serial1/1, changed state to up
*Mar 1 00:16:19.355: %BGP-5-ADJCHANGE: neighbor 12.12.12.2 Up
R1(config-if)#do sh ip bgp
BGP table version is 18, local router ID is 1.1.1.1
Status codes: s suppressed, d damped, h history, * valid, > best, i -
internal,
                r RIB-failure, S Stale
Origin codes: i - IGP, e - EGP, ? - incomplete

   Network          Next Hop          Metric LocPrf Weight Path
*> 1.1.1.1/32       0.0.0.0            0         32768 i
*> 4.4.4.4/32       12.12.12.2        100        0 23 4 i
*                   13.13.13.3         0          0 23 4 i
*> 12.12.12.0/24    0.0.0.0            0         32768 i
*> 13.13.13.0/24    0.0.0.0            0         32768 i
*> 23.23.23.0/24    12.12.12.2         0          0 23 i
*                   13.13.13.3         0          0 23 i
*> 24.24.24.0/24    12.12.12.2        100        0 23 4 i
*                   13.13.13.3         0          0 23 4 i
*> 34.34.34.0/24    12.12.12.2        100        0 23 4 i
*                   13.13.13.3         0          0 23 4 i
R1(config-if)#

```

Oke sip.

## BGP Dualhoming – Set MED

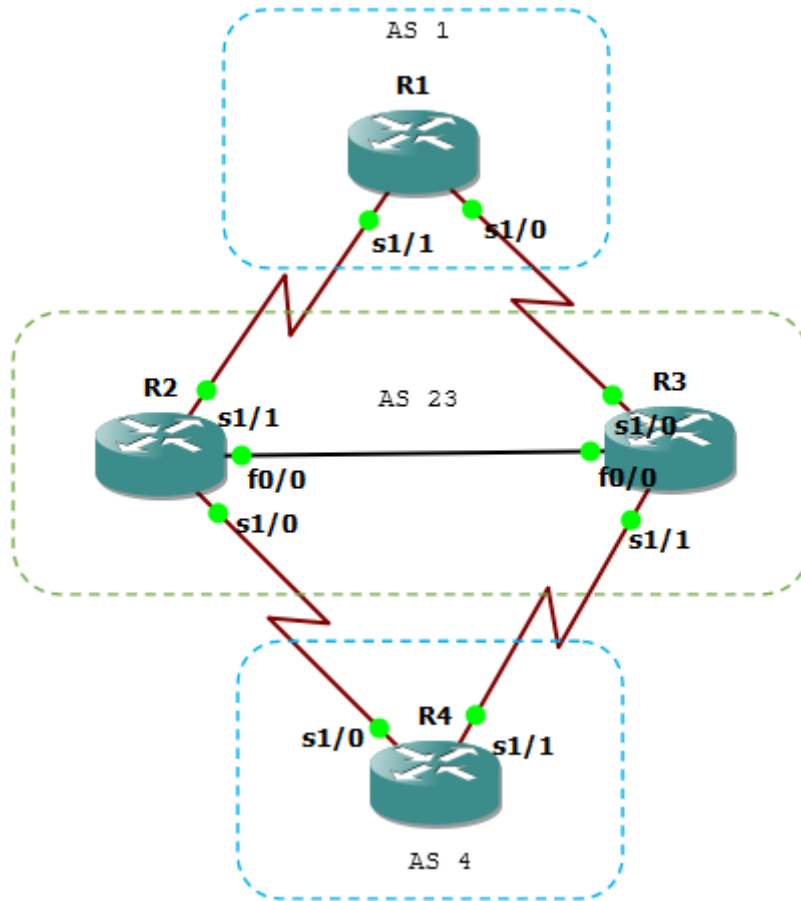

Selain mengatur traffic yang keluar dari R1, juga bisa mengatur traffic yang menuju R1 salah satunya dengan MED atau metric.

```
R1(config)#ip access-list standard LAN
R1(config-std-nacl)#permit 1.1.1.1
R1(config-std-nacl)#route-map R2MED permit 10
R1(config-route-map)#match ip address LAN
R1(config-route-map)#set metric 110
R1(config-route-map)#route-map R3MED permit 10
R1(config-route-map)#match ip address LAN
R1(config-route-map)#set metric 100
R1(config-route-map)#
R1(config-route-map)#router bgp 1
R1(config-router)#neighbor 12.12.12.2 route-map R2MED out
R1(config-router)#neighbor 13.13.13.3 route-map R3MED out
R1(config-router)#do clear ip bgp *
```

Cek di R2. Sekarang untuk menuju ke 1.1.1.1, akan dilewatkan 23.23.23.3 lalu ke 13.13.13.1 terlebih dahulu.

```
R2(config-router)#do sh ip bgp
BGP table version is 23, local router ID is 24.24.24.2
Status codes: s suppressed, d damped, h history, * valid, > best, i -
internal,
```

```

r RIB-failure, S Stale
Origin codes: i - IGP, e - EGP, ? - incomplete

  Network          Next Hop          Metric LocPrf Weight Path
*>i1.1.1.1/32      23.23.23.3        100    100      0 1 i
*                  12.12.12.1        110      0 1 i
* i4.4.4.4/32      23.23.23.3         0     100      0 4 i
*>                 24.24.24.4         0      0 4 i
*> 23.23.23.0/24   0.0.0.0           0     32768 i
* i                23.23.23.3         0     100      0 i
r i24.24.24.0/24   23.23.23.3         0     100      0 4 i
r>                 24.24.24.4         0      0 4 i
* i34.34.34.0/24   23.23.23.3         0     100      0 4 i
*>                 24.24.24.4         0      0 4 i
R2(config-router)#do trace 1.1.1.1

Type escape sequence to abort.
Tracing the route to 1.1.1.1

 1 23.23.23.3 56 msec 100 msec 64 msec
 2 13.13.13.1 112 msec 84 msec 72 msec
R2(config-router)#

```

## BGP Dualhoming – Set AS Path

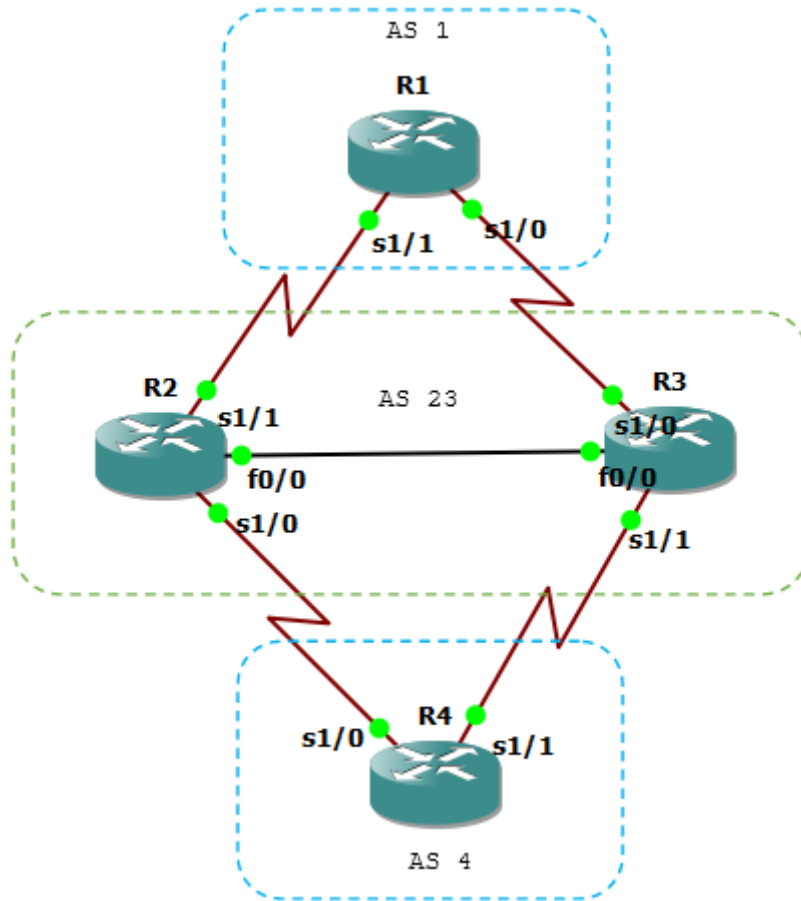

Mengatur traffic yang menuju R1 selain menggunakan metric juga bisa menggunakan AS Path. Hapus dulu MED nya.

```
R1(config-router)#no neighbor 12.12.12.2 route-map R2MED out
R1(config-router)#no neighbor 13.13.13.3 route-map R3MED out
```

Sekarang set as-path pada route-map.

```
R1(config)#route-map AS-PREPEND
R1(config-route-map)#set as-path prepend 1 1 1
R1(config-route-map)#router bgp 1
R1(config-router)#neighbor 12.12.12.2 route-map AS-PREPEND out
R1(config-router)#do clear ip bgp *
```

Cek.

```
R2#traceroute 1.1.1.1

Type escape sequence to abort.
Tracing the route to 1.1.1.1

 0  1.1.1.1 [AS 0] 0 msec 0 msec 0 msec
 1  23.23.23.3 60 msec 96 msec 44 msec
 2  13.13.13.1 [AS 1] 80 msec 92 msec 80 msec
R2#
```

## BGP Multihoming – Equal Load Balance

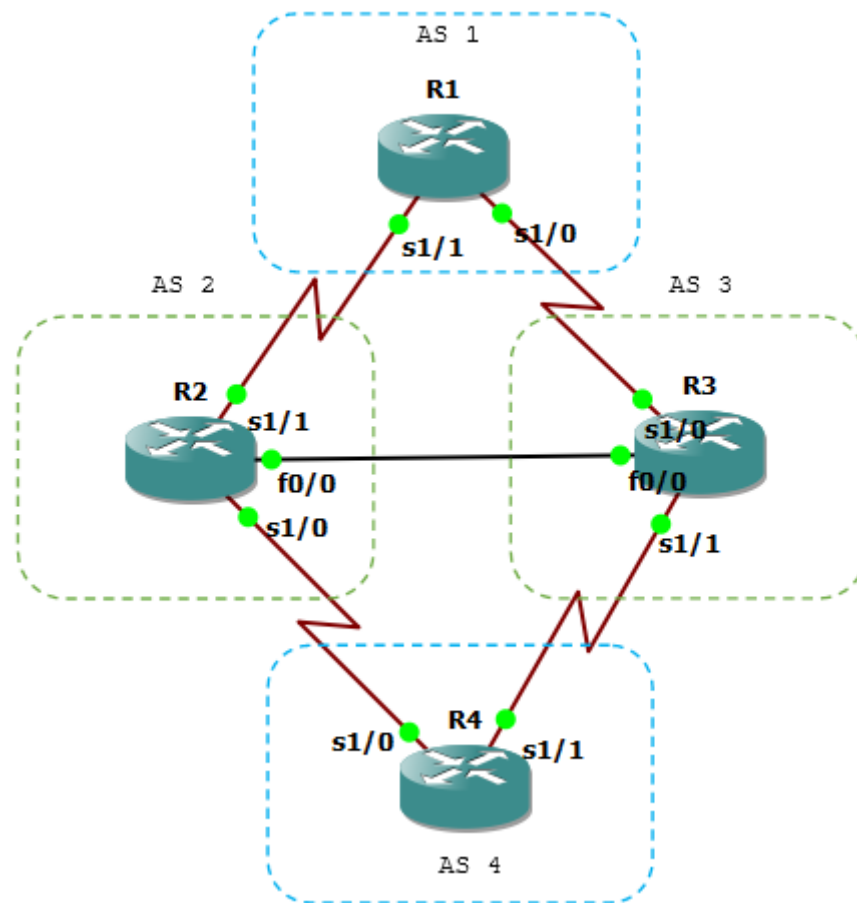

Tujuannya agar dapat load balance melalui 2 AS atau 2 ISP.

Hapus AS 23 dan ubah menjadi masing-masing AS 2 dan AS 3. Hapus juga route-map sebelumnya.

```
R1(config)#router bgp 1
R1(config-router)#no neighbor 12.12.12.2 remote-as 23
R1(config-router)#neighbor 12.12.12.2 remote-as 2
R1(config-router)#no neighbor 12.12.12.2 route-map AS-PREPEND out
R1(config-router)#no neighbor 13.13.13.3 remote-as 23
R1(config-router)#neighbor 13.13.13.3 remote-as 3

R2(config)#no router bgp 23
R2(config)#router bgp 2
R2(config-router)#neighbor 12.12.12.1 remote-as 1
R2(config-router)#neighbor 24.24.24.4 remote-as 4
R2(config-router)#neighbor 23.23.23.3 remote-as 3

R3(config)#no router bgp 23
R3(config)#router bgp 3
R3(config-router)#neighbor 34.34.34.4 remote-as 4
R3(config-router)#neighbor 13.13.13.1 remote-as 1
R3(config-router)#neighbor 23.23.23.2 remote-as 2
R4(config)#router bgp 4
```

```
R4(config-router)#no neighbor 24.24.24.2 remote-as 23
R4(config-router)#neighbor 24.24.24.2 remote-as 2
R4(config-router)#no neighbor 34.34.34.3 remote-as 23
R4(config-router)#neighbor 34.34.34.3 remote-as 3
```

### Konfigurasi load balance pada R1.

```
R1(config)#router bgp 1
R1(config-router)#maximum-paths 2
R1#trace 4.4.4.4

Type escape sequence to abort.
Tracing the route to 4.4.4.4

 0  12.12.12.2 104 msec 72 msec 48 msec
 1  24.24.24.4 [AS 4] 140 msec 92 msec 64 msec
R1#
```

Ternyata walau sudah dikonfigurasi maximum-path, tetap saja belum load-balance. Tambahkan konfigurasi dibawah.

```
R1(config)#router bgp 1
R1(config-router)#bgp bestpath as-path multipath-relax
R1(config-router)#do clear ip bgp *
```

Oke tunggu bentar dan sekarang cek lagi.

```
R1(config-router)#do trace 4.4.4.4

Type escape sequence to abort.
Tracing the route to 4.4.4.4

 0  13.13.13.3 116 msec
   12.12.12.2 108 msec
   13.13.13.3 88 msec
 2  24.24.24.4 [AS 4] 204 msec
   34.34.34.4 [AS 4] 44 msec
   24.24.24.4 [AS 4] 92 msec
R1(config-router)#
```

Sip sudah load-balance.

```
R1(config)#router bgp 1
R1(config-router)#maximum-paths 2
R1#trace 4.4.4.4

Type escape sequence to abort.
Tracing the route to 4.4.4.4

 0  12.12.12.2 104 msec 72 msec 48 msec
 1  24.24.24.4 [AS 4] 140 msec 92 msec 64 msec
R1#
```

## BGP Multihoming – Unequal Load Balance

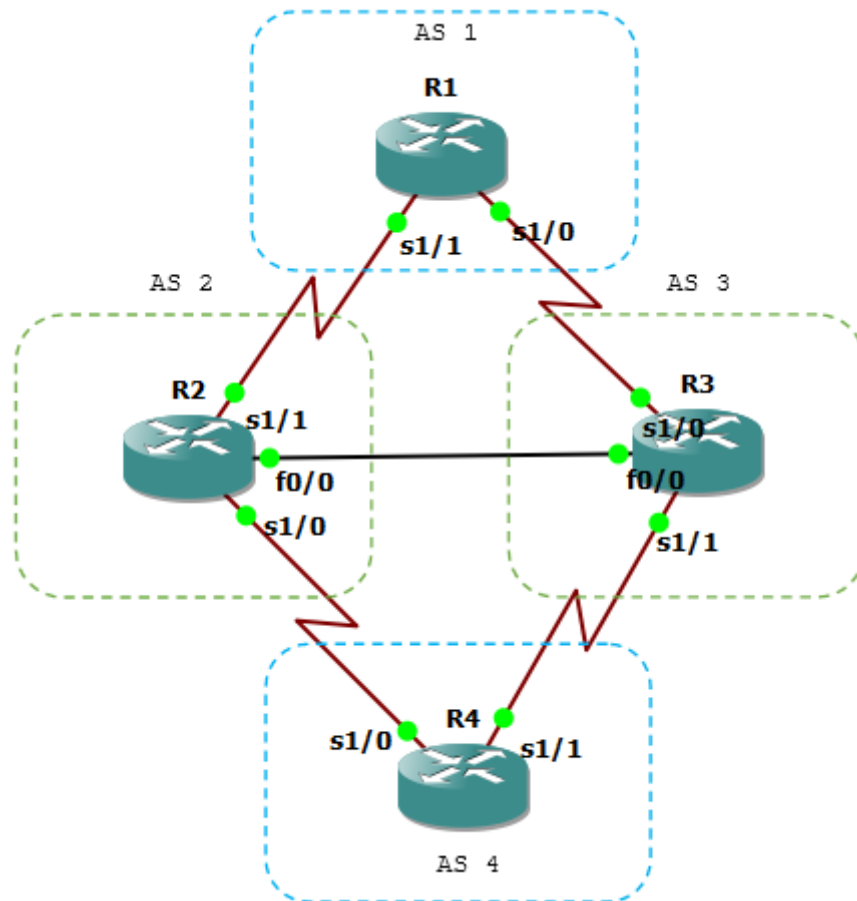

Permasalahan terjadi ketika link ke AS 4 melalui AS 2 dan AS 3 berbeda bandwidth.

```
R1(config)#int s1/0
R1(config-if)#bandwidth 100
R1(config-if)#int s1/1
R1(config-if)#bandwidth 200
R1(config-if)#do clear ip bgp *

R1(config-if)#do sh ip bgp
BGP table version is 7, local router ID is 1.1.1.1
Status codes: s suppressed, d damped, h history, * valid, > best, i -
internal,
                r RIB-failure, S Stale
Origin codes: i - IGP, e - EGP, ? - incomplete

   Network        Next Hop           Metric LocPrf Weight Path
*> 1.1.1.1/32     0.0.0.0             0         32768 i
*  4.4.4.4/32     13.13.13.3         0         3 4 i
*>                12.12.12.2         0         2 4 i
*> 12.12.12.0/24 0.0.0.0             0         32768 i
```



```
*> 13.13.13.0/24      0.0.0.0          0          32768 i
* 24.24.24.0/24      13.13.13.3       0 3 4 i
*>                    12.12.12.2       0 2 4 i
* 34.34.34.0/24      13.13.13.3       0 3 4 i
*>                    12.12.12.2       0 2 4 i
```

```
R1(config-if)#do sh ip route 4.4.4.4
Routing entry for 4.4.4.4/32
  Known via "bgp 1", distance 20, metric 0
  Tag 2, type external
  Last update from 12.12.12.2 00:00:16 ago
  Routing Descriptor Blocks:
    * 13.13.13.3, from 13.13.13.3, 00:00:16 ago
      Route metric is 0, traffic share count is 1
      AS Hops 2
      Route tag 2
    12.12.12.2, from 12.12.12.2, 00:00:16 ago
      Route metric is 0, traffic share count is 1
      AS Hops 2
      Route tag 2
```

```
R1(config-if)#
```

Maka akan didapati perbandingan bandwidthnya masih 1:1. Bagaimana jika perbedaan bandwidthnya jauh?

```
R1(config-if)#router bgp 1
R1(config-router)#bgp dmzlink-bw
R1(config-router)#neighbor 12.12.12.2 dmzlink-bw
R1(config-router)#neighbor 13.13.13.3 dmzlink-bw
R1(config-router)#do clear ip bgp *
```

Oke cek lagi.

```
R1(config-router)#do sh ip route 4.4.4.4
Routing entry for 4.4.4.4/32
  Known via "bgp 1", distance 20, metric 0
  Tag 2, type external
  Last update from 13.13.13.3 00:00:15 ago
  Routing Descriptor Blocks:
    13.13.13.3, from 13.13.13.3, 00:00:15 ago
      Route metric is 0, traffic share count is 23
      AS Hops 2
      Route tag 2
    * 12.12.12.2, from 12.12.12.2, 00:00:15 ago
      Route metric is 0, traffic share count is 48
      AS Hops 2
      Route tag 2
```

```
R1(config-router)#
```

Oke sudah berhasil.

Attributes	
Name	Description
<b>Well-known Mandatory</b> · Must be supported and propagated	
<b>1 Origin</b>	Origin type (IGP, EGP, or unknown)
<b>2 AS Path</b>	List of autonomous systems which the advertisement has traversed
<b>3 Next Hop</b>	External peer in neighboring AS
<b>Well-known Discretionary</b> · Must be supported; propagation optional	
<b>5 Local Preference</b>	Metric for internal neighbors to reach external destinations (default 100)
<b>6 Atomic Aggregate</b>	Includes ASes which have been dropped due to route aggregation
<b>Optional Transitive</b> · Marked as partial if unsupported by neighbor	
<b>7 Aggregator</b>	ID and AS of summarizing router
<b>8 Community</b>	Route tag
<b>Optional Nontransitive</b> · Deleted if unsupported by neighbor	
<b>4 Multiple Exit Discriminator (MED)</b>	Metric for external neighbors to reach the local AS (default 0)
<b>9 Originator ID</b>	The originator of a reflected route
<b>10 Cluster List</b>	List of cluster IDs
<b>13 Cluster ID</b>	Originating cluster
<b>-- Weight</b>	Cisco proprietary, not communicated to peers (default 0)

Path Selection		
Attribute	Description	Preference
<b>1 Weight</b>	Administrative preference	Highest
<b>2 Local Preference</b>	Communicated between peers within an AS	Highest
<b>3 Self-originated</b>	Prefer paths originated locally	True
<b>4 AS Path</b>	Minimize AS hops	Shortest
<b>5 Origin</b>	Prefer IGP-learned routes over EGP, and EGP over unknown	IGP
<b>6 MED</b>	Used externally to enter an AS	Lowest
<b>7 External</b>	Prefer eBGP routes over iBGP	eBGP
<b>8 IGP Cost</b>	Consider IGP metric	Lowest
<b>9 eBGP Peering</b>	Favor more stable routes	Oldest
<b>10 Router ID</b>	Tie breaker	Lowest

Influencing Path Selection			
<b>Weight</b>	neighbor 172.16.0.1 weight 200	<b>Local Preference</b>	bgp default local-preference 100
<b>MED</b>	default-metric 400	<b>Route Map</b>	neighbor 172.16.0.1 route-map Foo
<b>Ignore AS Path</b>	bgp bestpath as-path ignore	<b>Ignore Cost Communities</b>	bgp bestpath cost-community ignore

About BGP	
Type	Path Vector
<b>eBGP AD</b>	20
<b>iBGP AD</b>	200
<b>Standard</b>	RFC 4271
<b>Protocols</b>	IP
<b>Transport</b>	TCP/179
<b>Authentication</b>	MD5

Terminology	
<b>Autonomous System (AS)</b>	A logical domain under the control of a single entity
<b>External BGP (eBGP)</b>	BGP adjacencies which span autonomous system boundaries
<b>Internal BGP (iBGP)</b>	BGP adjacencies formed within a single AS
<b>Synchronization Requirement</b>	A route must be known by an IGP before it may be advertised to BGP peers

Packet Types	
<b>Open</b>	<b>Update</b>
<b>Keepalive</b>	<b>Notification</b>

Neighbor States	
<b>Idle</b>	· Neighbor is not responding
<b>Active</b>	· Attempting to connect
<b>Connect</b>	· TCP session established
<b>Open Sent</b>	· Open message sent
<b>Open Confirm</b>	· Response received
<b>Established</b>	· Adjacency established

Troubleshooting	
show ip bgp [summary]	
show ip bgp neighbors	
show ip route [bgp]	
clear ip bgp * [soft]	
debug ip bgp [...]	

## Configuration Example

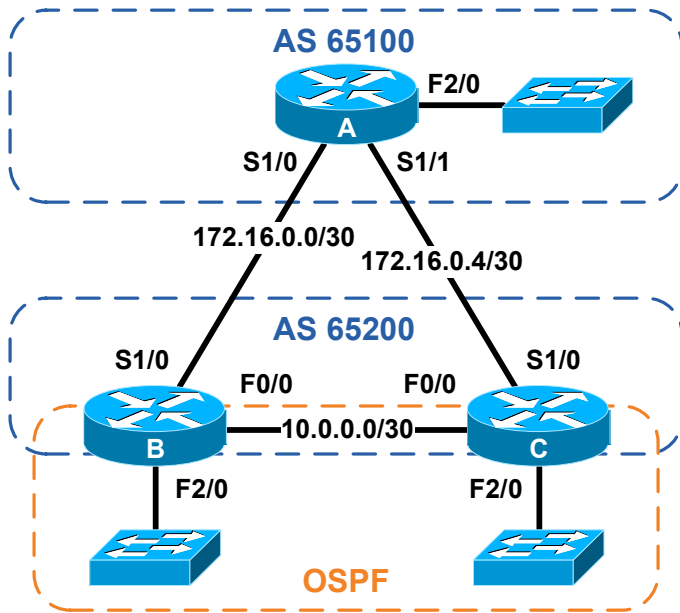

```

interface Serial1/0
description Backbone to B
ip address 172.16.0.1 255.255.255.252
!
interface Serial1/1
description Backbone to C
ip address 172.16.0.5 255.255.255.252
!
interface FastEthernet2/0
description LAN
ip address 192.168.1.1 255.255.255.0
!
router bgp 65100
no synchronization
network 172.16.0.0 mask 255.255.255.252
network 172.16.0.4 mask 255.255.255.252
network 192.168.1.0
neighbor South peer-group
neighbor South remote-as 65200
neighbor 172.16.0.2 peer-group South
neighbor 172.16.0.6 peer-group South
no auto-summary
    
```

```

interface FastEthernet0/0
description Backbone to C
ip address 10.0.0.1 255.255.255.252
!
interface Serial1/0
description Backbone to A
ip address 172.16.0.2 255.255.255.252
!
interface FastEthernet2/0
description LAN
ip address 192.168.2.1 255.255.255.0
!
router ospf 100
network 10.0.0.1 0.0.0.0 area 0
network 192.168.2.1 0.0.0.0 area 1
!
router bgp 65200
no synchronization
redistribute ospf 100 route-map LAN_Subnets
neighbor 10.0.0.2 remote-as 65200
neighbor 172.16.0.1 remote-as 65100
no auto-summary
!
access-list 10 permit 192.168.0.0 0.0.255.255
!
route-map LAN_Subnets permit 10
match ip address 10
set metric 100
    
```

```

interface FastEthernet0/0
description Backbone to B
ip address 10.0.0.2 255.255.255.252
!
interface Serial1/0
description Backbone to A
ip address 172.16.0.6 255.255.255.252
!
interface FastEthernet2/0
description LAN
ip address 192.168.3.1 255.255.255.0
!
router ospf 100
network 10.0.0.2 0.0.0.0 area 0
network 192.168.3.1 0.0.0.0 area 2
!
router bgp 65200
no synchronization
redistribute ospf 100 route-map LAN_Subnets
neighbor 10.0.0.1 remote-as 65200
neighbor 172.16.0.5 remote-as 65100
no auto-summary
!
access-list 10 permit 192.168.0.0 0.0.255.255
!
route-map LAN_Subnets permit 10
match ip address 10
set metric 100
    
```

### Router A Routing Table

```

172.16.0.0/30 is subnetted, 2 subnets
C    172.16.0.4 is directly connected, S1/1
C    172.16.0.0 is directly connected, S1/0
C    192.168.1.0/24 is directly connected, F2/0
B    192.168.2.0/24 [20/100] via 172.16.0.2
B    192.168.3.0/24 [20/100] via 172.16.0.2
    
```

### Router B Routing Table

```

172.16.0.0/30 is subnetted, 2 subnets
B    172.16.0.4 [20/0] via 172.16.0.1
C    172.16.0.0 is directly connected, S1/0
10.0.0.0/30 is subnetted, 1 subnets
C    10.0.0.0 is directly connected, F0/0
B    192.168.1.0/24 [20/0] via 172.16.0.1
C    192.168.2.0/24 is directly connected, F2/0
0 IA 192.168.3.0/24 [110/2] via 10.0.0.2, F0/0
    
```

# ABOUT AUTHOR

Name : Muhammad Taufik  
Website : <http://muhammadtaufik7.wordpress.com>  
Email : [muhammadtaufik951@gmail.com](mailto:muhammadtaufik951@gmail.com)  
Facebook : [facebook.com/MuhammadTaufiq72](https://www.facebook.com/MuhammadTaufiq72)

# NOTES

# NOTES

# NOTES

# THE WAY TO BE CISCO WARRIOR TEORY AND PRACTICE

