

Introduction to FTTx Networks

Larry Johnson
Director & Founder

Presented by

The LIGHT BRIGADE

www.lightbrigade.com

PLEASE!

- Cell phones and pagers on silent or vibrate mode.
- No photography, video taping, or audio taping is permitted.



Basic FTTx Terminology

- FTTP — Fiber to the premises (generic).
- FTTC — Fiber to the curb or cabinet.
- FTTA — Fiber to the antenna
 - FTTCell.
- FTTB — Fiber to the business or building.
 - MDU – Multiple dwelling unit.
 - MTU – Multiple tenant unit.
- FTTH — Fiber to the home.
- FTTN — Fiber to the node or neighborhood.
- FTTx — Fiber to the “x” (generic).

Today's Applications

- Business.
 - Symmetrical.
- Residential.
 - Asymmetrical.
- Triple play.
 - Voice, video, data.
- Impact of Internet protocol (IP).
 - Voice over IP (VoIP).
 - Video over IP (IPTV).
 - High speed data.

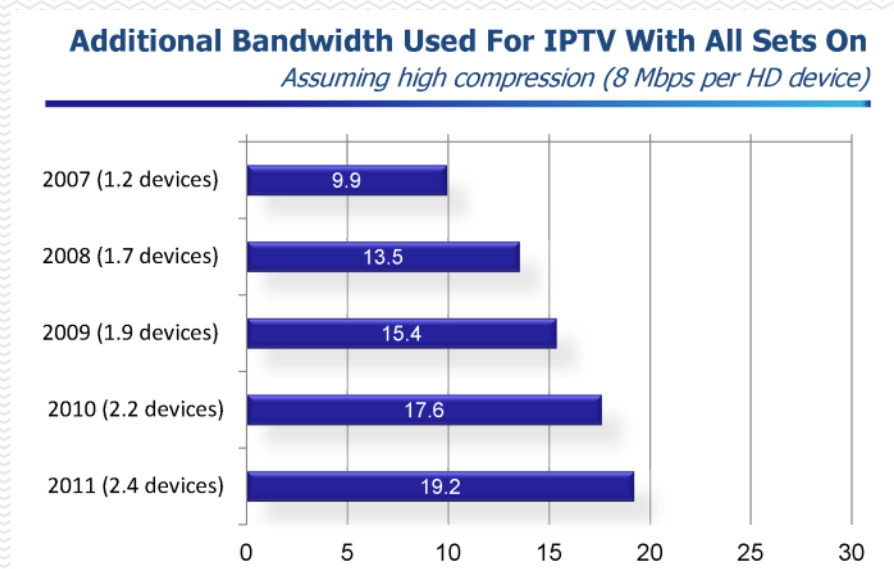

Courtesy Render, Vanderslice and Associates

FTTx Protocols

- B-PON (ATM-PON).
- G-PON (Gigabit PON).
- 10G-PON (10 Gigabit PON).
- EPON (Ethernet PON).
- Active Ethernet (AE).
- 10GEPON (10 Gigabit Ethernet PON).
- RF overlay.
- Radio frequency over glass (RFoG).
- Wavelength division multiplexed PON (WDM-PON).

Planning and Design of the FTTH Network

- Planning and design.
- FTTH or FTTB.
- Greenfield.
- Brownfield.
- Density.
- Take rate.
- Client profiles.
- Types of services.
- Protocol.

Fiber Optic Transmission

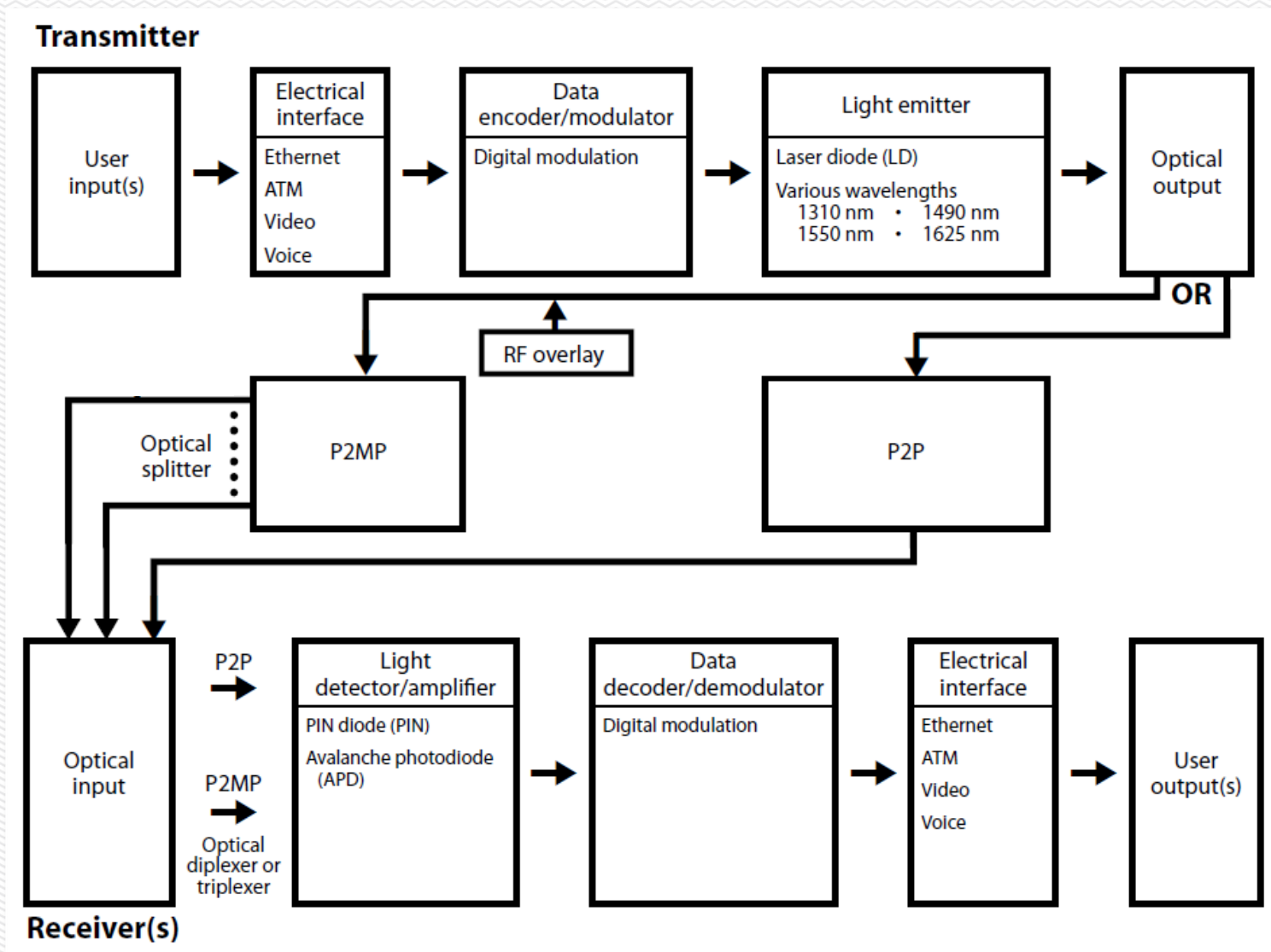

Lightwave Transmission

Attenuation and Wavelength

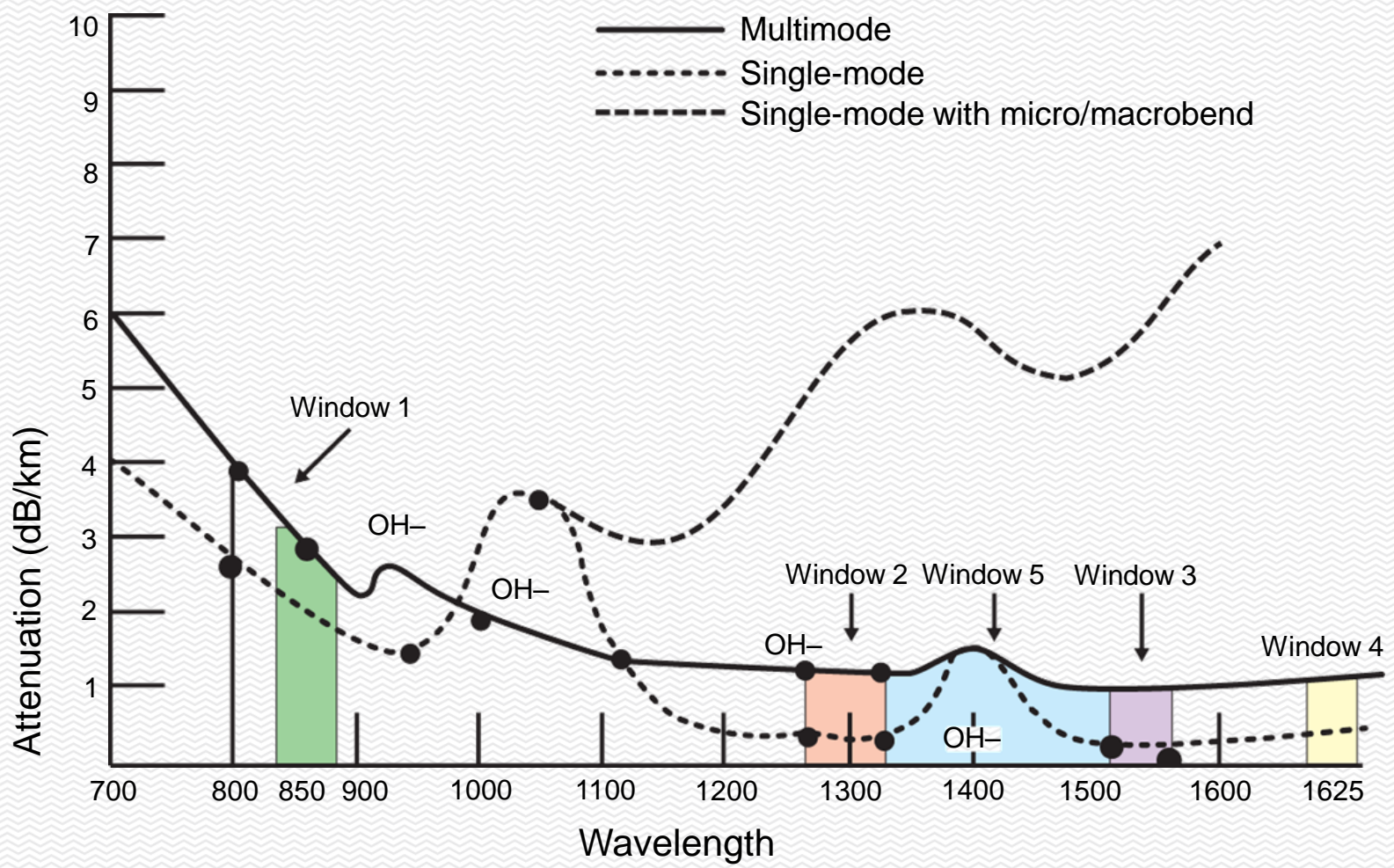

Lightwave Transmission

Transmission Bands

Wavelength	Band	Purpose	Fiber Type
1260 to 1360 nm	O-band	SOA operation	G.652 SMF
1360 to 1460 nm	E-band	For future use	G.652.D SMF
1460 to 1530 nm	S-band	Downstream FTTx operation	G.652, G.655 SMF
1530 to 1565 nm	C-band	EDFA and SOA operation	G.655 SMF
1565 to 1625 nm	L-band	For future use; DWDM monitoring	G.655 SMF
1625 to 1675 nm	U-band	For future use	G.655 SMF

“Band” terminology
used in FTTx/PON:
ITU-T G.983/984

Basic band (1480 to 1500 nm)
Enhancement band (1550 to 1560 nm)

ITU-T G.652 Single-mode Optical Fiber

- Specified by all FTTx standards.
- Legacy SMF for ILECs, utilities, and municipalities.
- Optimized for dispersion at 1310 nm.
- Optimized for attenuation at 1550 nm.
- Manufactured with various techniques.
- Cutoff wavelength is 1260 nm.

Single-mode Fiber

ITU-T G.657 Single-mode Optical Fibers

Bend-insensitive Fibers

- Variation of G.652 single-mode fiber.
- Ideal for FTTB installations.
- Designed to handle extrinsic stresses.
- G.657.B3 has the smallest bend radius values and the smallest attenuation values.

Bend Insensitive Fiber

Gigabit PON

G-PON

- ITU-T G.984.
- Released in 2004.
- Transmits ATM cells and Ethernet packets using G-PON encapsulation method (GEM).
- Data rates up to 2.488 Gb/s.
- 1:32 and 1:64 splitter options.
- RF overlay at 1550 nm.
- G.983 physical layer criteria.
 - Distance.
 - Wavelengths.
 - Bidirectional transmission.

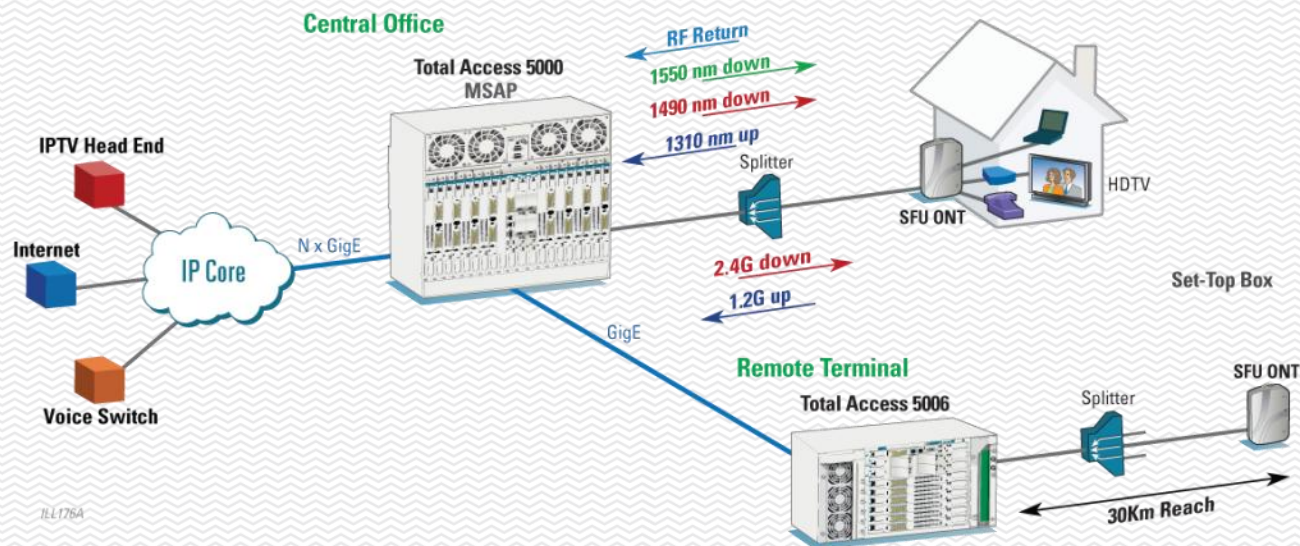

Courtesy ADTRAN, Inc.

Gigabit PON

- Each car represents ATM with a 53-kB cell loading.
- The more cars on the freeway, the longer it takes for information to be disseminated.
- All cars travel at the same speed.

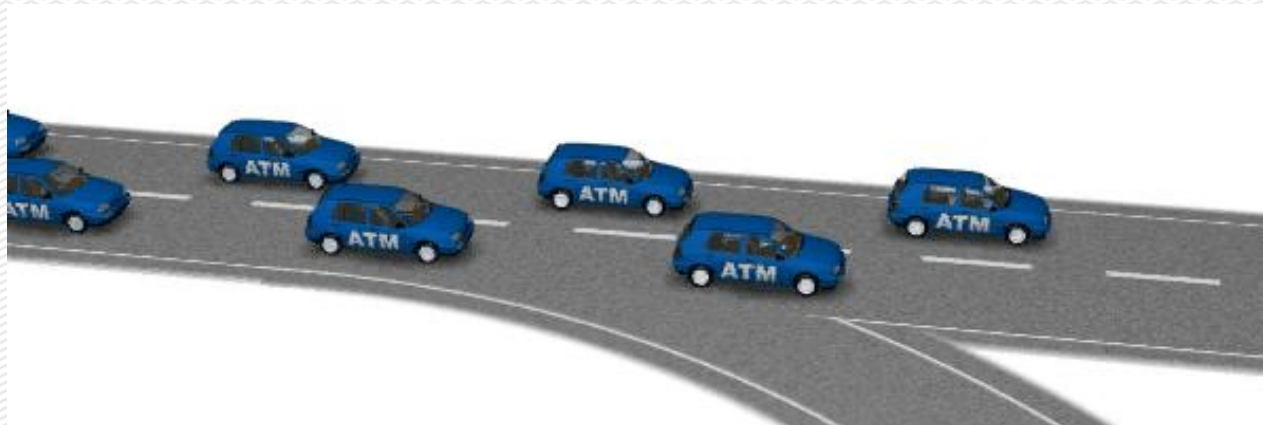

Gigabit PON

- Each truck represents Ethernet with 1,518 bytes loaded.
- All cars travel at the same speed as ATM.
- The more trucks on the freeway, the longer it takes for information to be disseminated.



Gigabit PON

- Both 53-kB cars and 1,518-byte trucks are loaded onto semis.
- All still travel at the same speed.
- Data is hauled using GEM, without changing its original protocol scheme.



IEEE 802.3ah EPON

- Ethernet in the first mile (EFM).
- Point-to-multipoint (P2MP) architecture.
- 10/100/1000 Mb/s.
- 10 and 20 km spans.
- Active Ethernet uses these same data rates but can have lengths up to 80 km without the use (loss) of optical splitters.
- Based on 802.3 standards of the 1980s.
- Dominant standard for IP transmission.
- Symmetrical and asymmetrical transmission.
- P2P and P2MP architectures.

POLAN

Passive Optical Local Area Networks

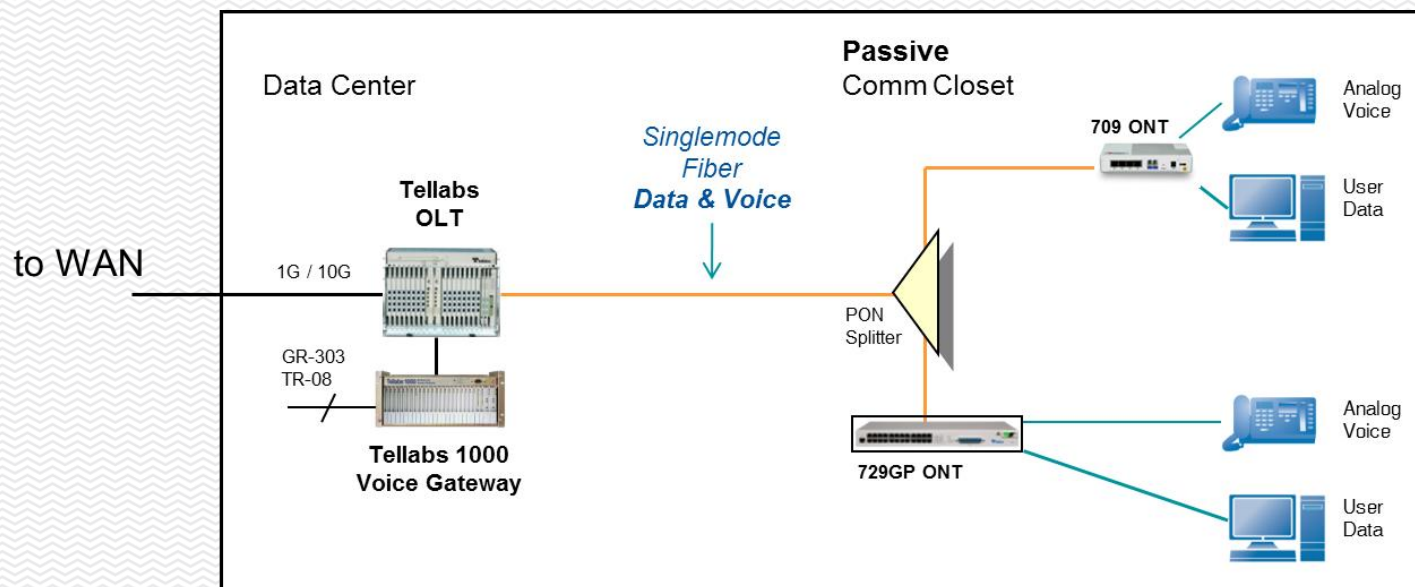

Courtesy
Tellabs

- Based on ITU G-PON standards.
- Based on elements of the TIA-568 structured wiring standard.
- LAN, campus, and FTTB focus.
- Bidirectional transmission over single-mode fibers.
- B class loss budgets.

RF Video Overlay

- Legacy CATV AM transmission.
- 1550 nm enhancement band.
- External WDM overlay option.

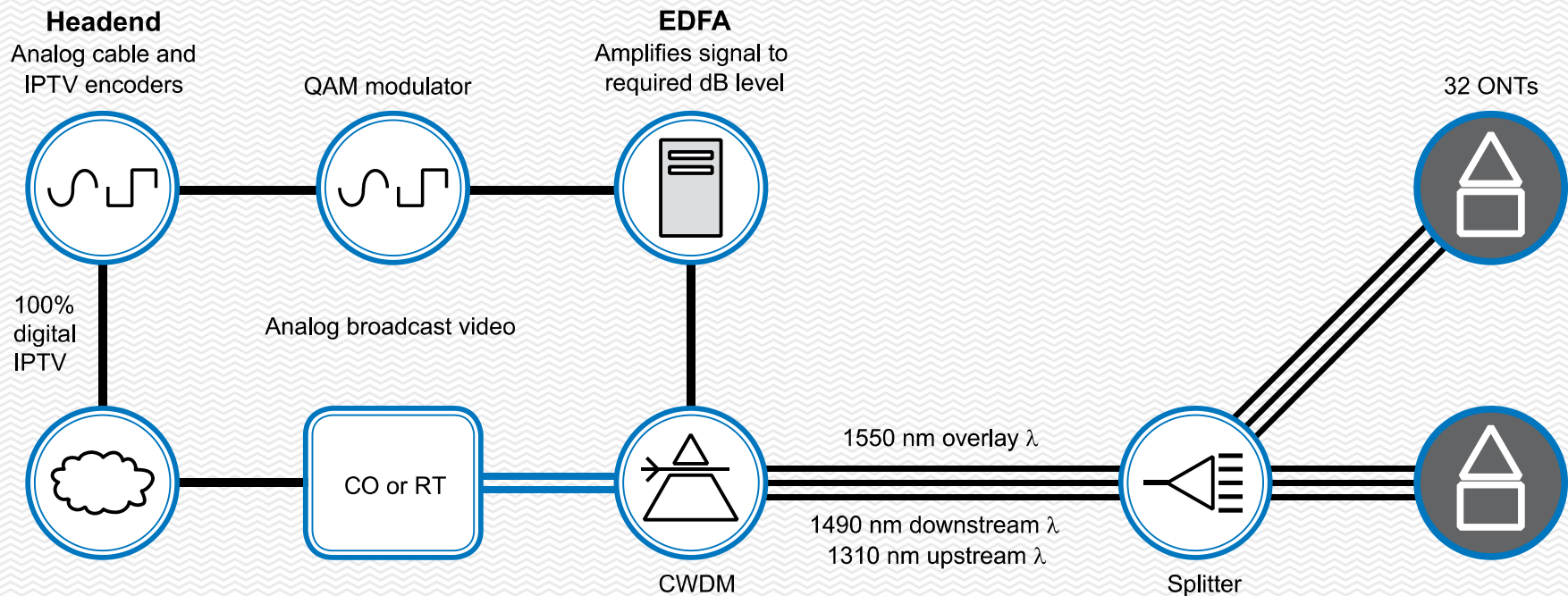

Courtesy Calix Networks

Radio Frequency over Glass

SCTE 174

- Defines a FTTH system using legacy HFC plant at the head end and subscriber.
- Designed for coexistence with or migration to G-PON.
- DOCSIS 3.0 migrations.
- New wavelength assignments.
 - 1610 nm upstream.
 - 1310 nm legacy upstream.

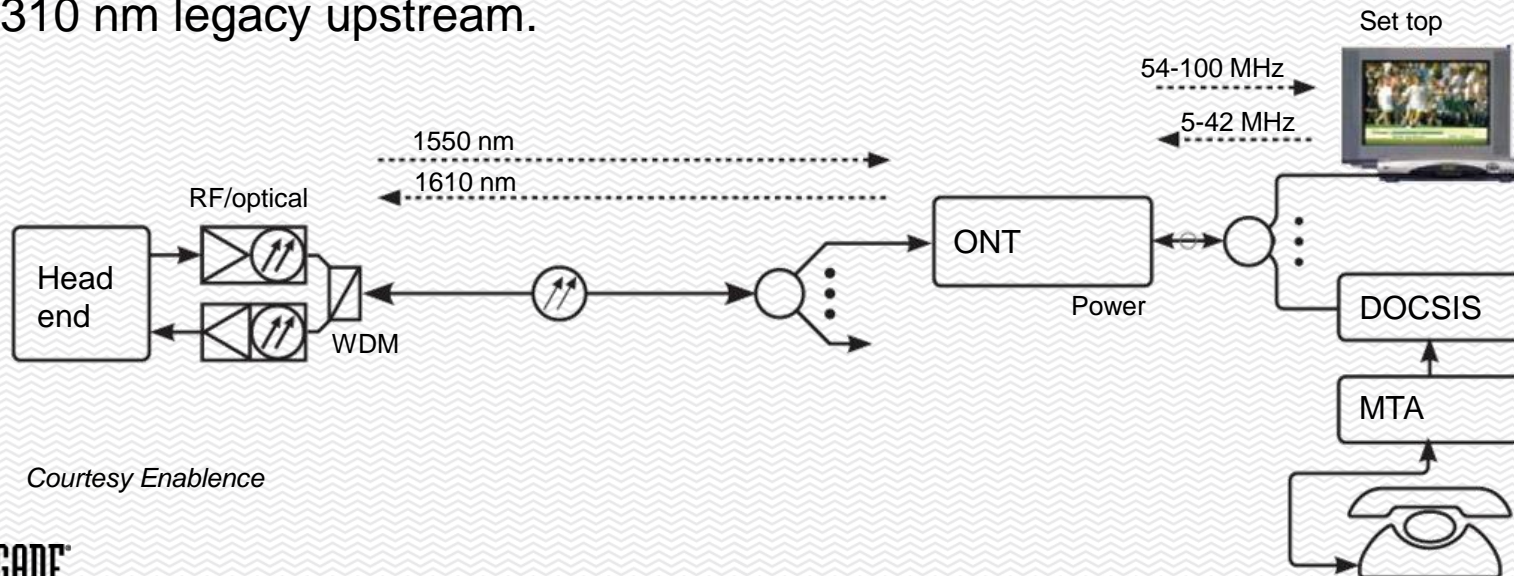

Courtesy Enablence

ITU-T G.987 and G.988 10G-PON

XG-PON Wavelength Allocation

- 10 Gb/s asymmetric and symmetric data rates.
- Coexists with legacy G-PON, BPON, and EPON standards.
- Backwards compatible with G.983 and G.984 ODNs.
- 1575-1580 nm downstream (1577 nm).
- 1260-1280 nm upstream.
 - Wavelength blocking filters required.

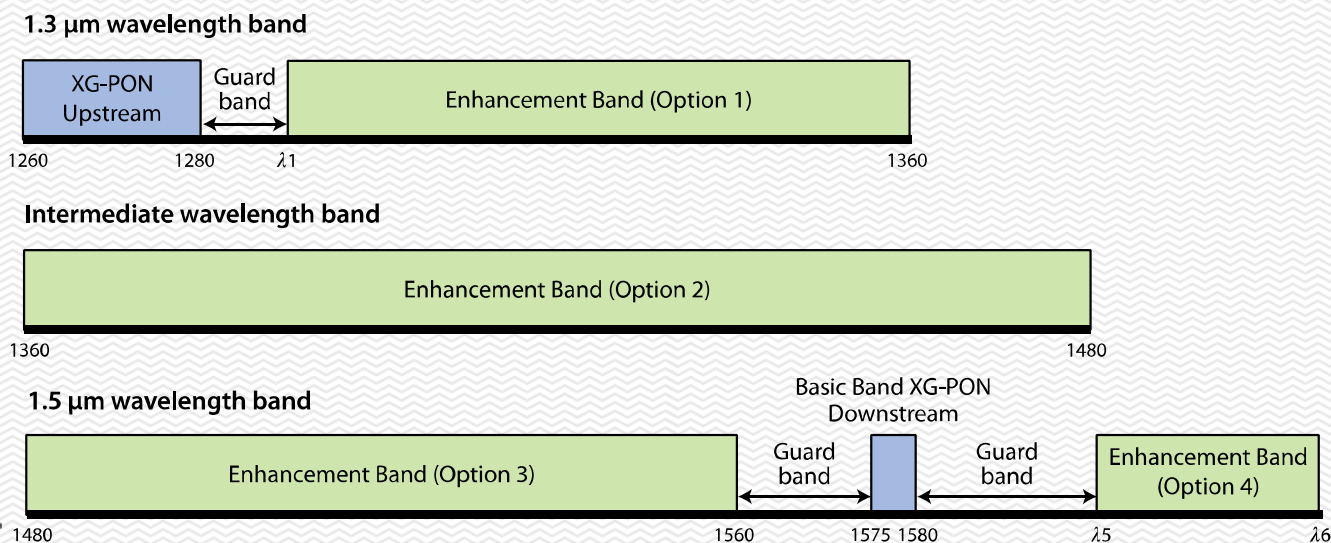

10GEPON

IEEE 802.3av

- 10, 100, 1,000, 10,000 Mb/s transmission.
 - Symmetric.
 - 10 Gb/s downstream, 10 Gb/s upstream.
 - Asymmetric.
 - 10 Gb/s downstream, 1 Gb/s upstream.
- Wavelengths.
 - Downstream: 1575-1580 nm (1577 nm).
 - Upstream: 1260-1280 nm.
- No RF overlay.
- Backwards compatible with EPON.
- 10 and 20 km spans.
- 20-29 dB loss budgets.
- Low power.
 - 10 km with 1:16 split.
- Medium power.
 - 20 km with 1:16 split.
- High power.
 - 20 km with 1:32 split.

Point to Point

P2P

- Traditional method of transmission.
 - Two fibers.
 - Single fiber bidirectional.
 - Active Ethernet.
- Requires powered cabinet in the OSP.
 - SFP modules used.
 - CWDM/DWDM for feeder.
 - Extended distances.

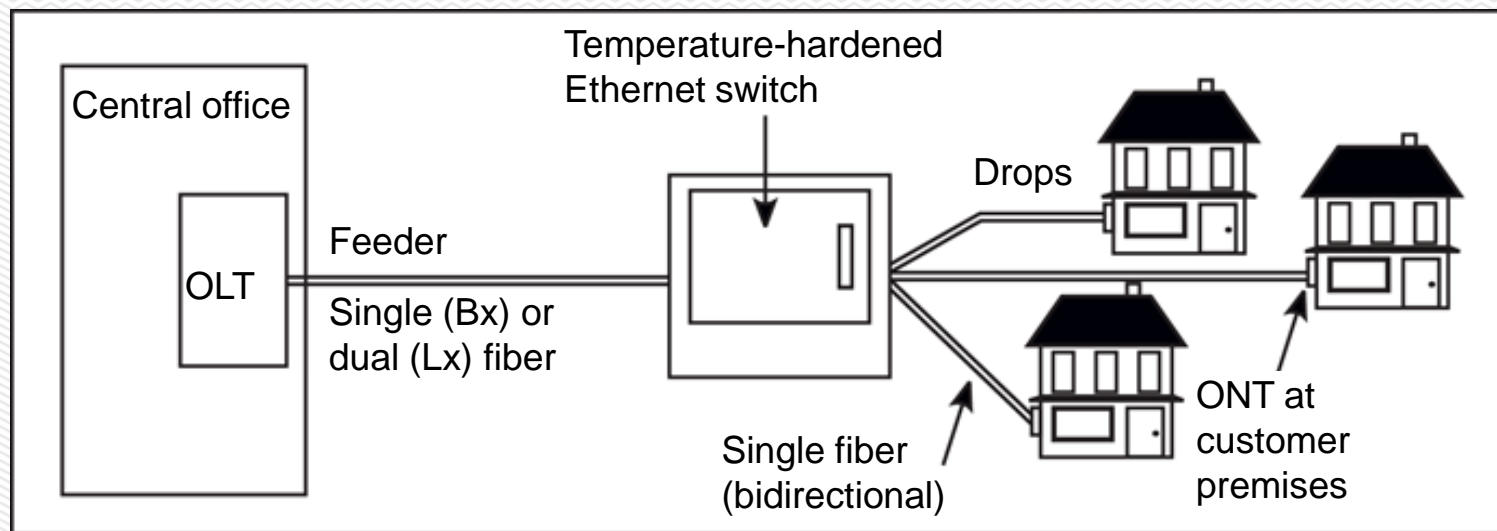

Point to Multipoint

P2MP

- Uses optical splitters.
- Passive optical network (PON).
- 20 km limitation.
- 1:64 splitter limitation.
- RF overlay option.
- Bidirectional with WDM.
- B-PON, G-PON, EPON, RFoG, 10G-PON

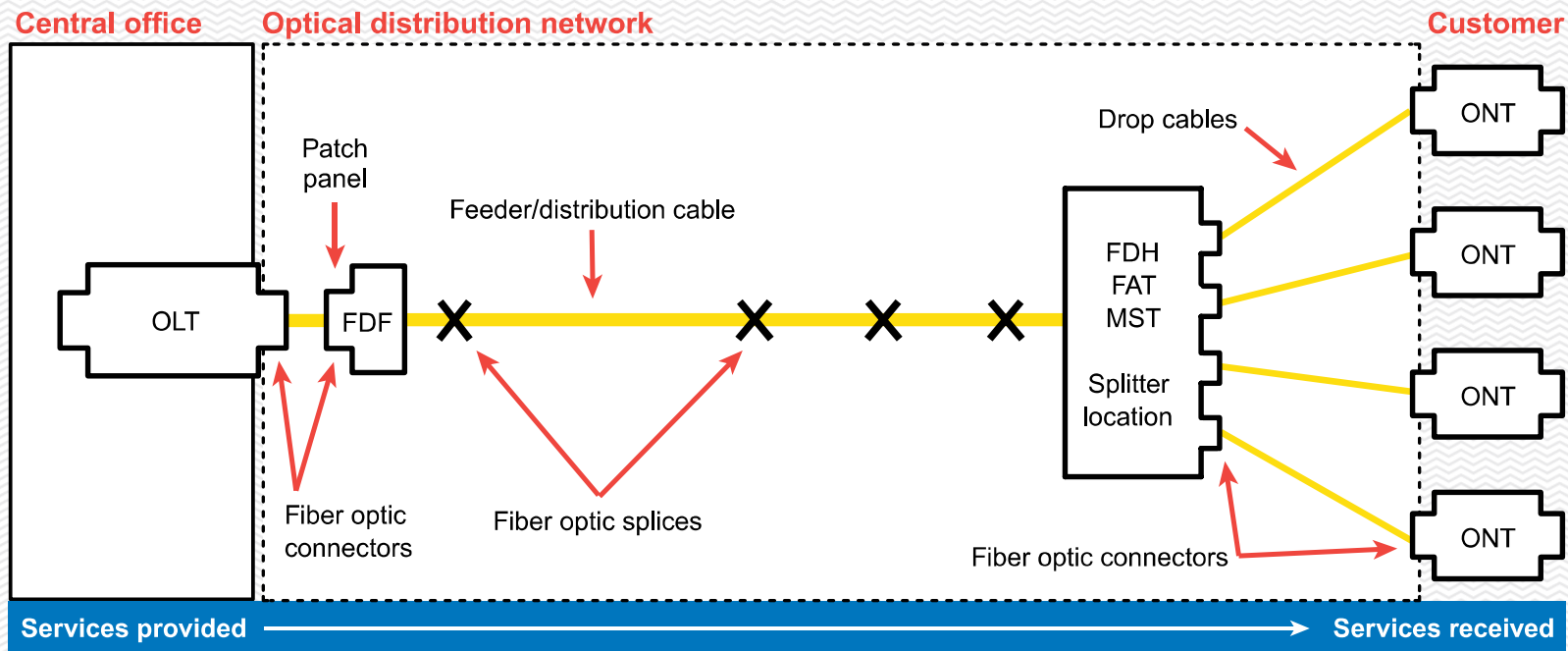

Triple Play Network Characteristics

	P2P (Active Ethernet)	P2MP (PON)
Signal delivery	Uses active electronics through dedicated Ethernet line	Uses splitters
Optical line	Dedicated	Shared
Applications	Better suited for applications similar to enterprise data	System solutions optimized for specific market applications
Cost	More expensive due to active equipment	Less expensive
Data rate	Max/peak bandwidth is >1 Gb/s to each customer immediate	75-150 Mb/s using 2.4 Gb/s OLT
Reach	80 km	20 km
Components	Integrated CO and subscriber components	Separate CO and subscriber electronics

Star Topology

- Active.
- Passive.
 - P2MP.
- Centralized.
- Distributed.
- Home run.

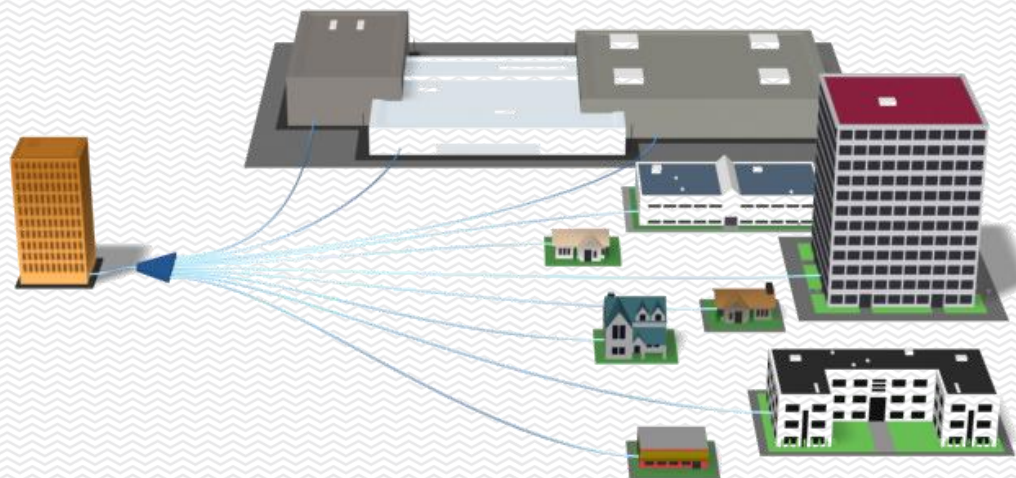
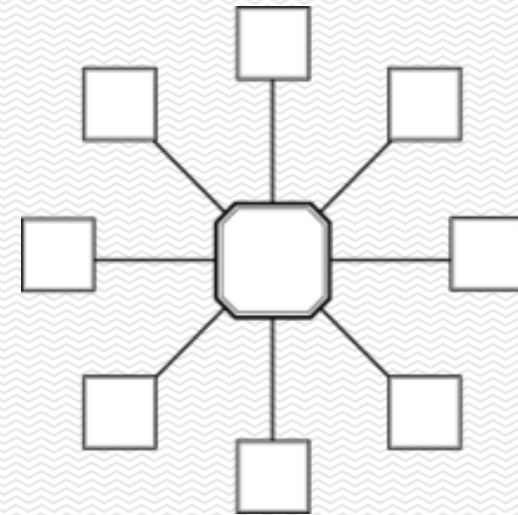

PON Star Configurations

Centralized Splitting

- Single splitter located in OSP.
- Housed in:
 - Fiber distribution hub (FDHs).
 - Fiber access terminal (FATs).
 - Multiservice terminal (MSTs).

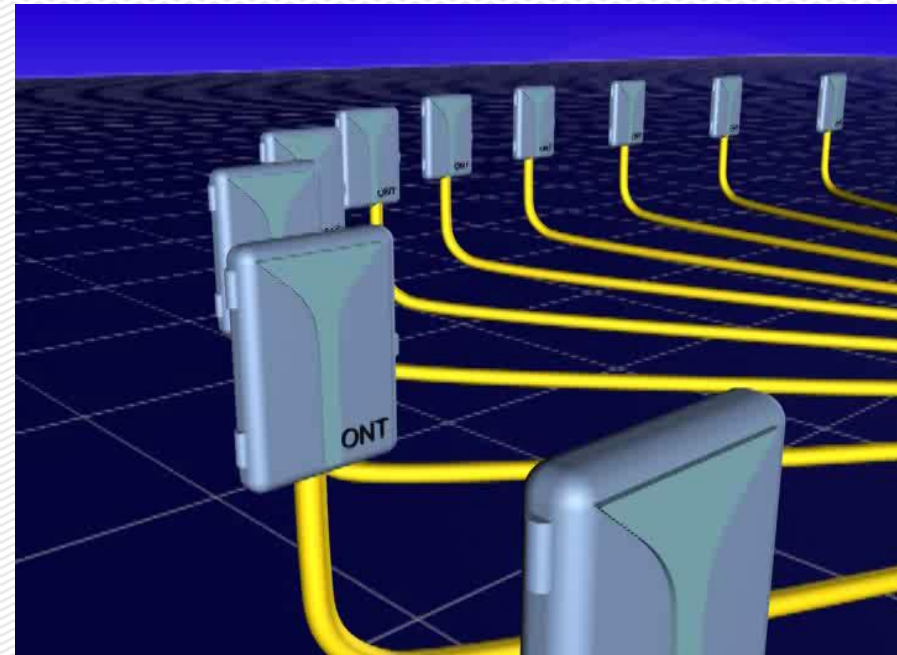

PON Star Configurations

Distributed Star

- Splitters located in two or more locations.
- Housed in:
 - Fiber distribution hub (FDHs).
 - Fiber access terminal (FATs).
 - Multiport service terminal (MSTs).
 - Splice closures.

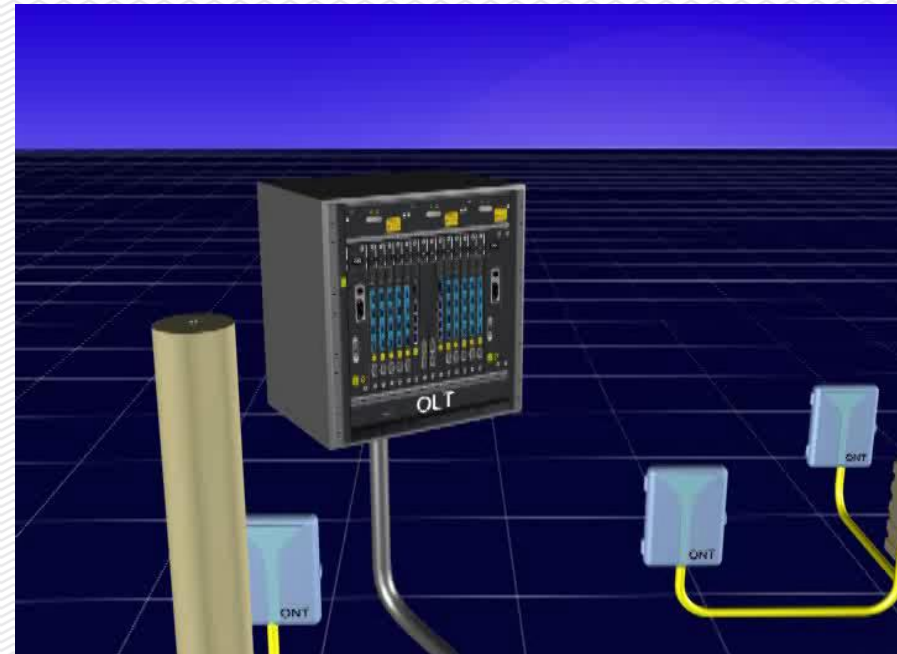

PON Star Configurations

Home Run

- Splitter housed in CO/headend.
- Easy physical fiber management.
- Requires fiber rich cables in OSP.
- Dense urban applications.

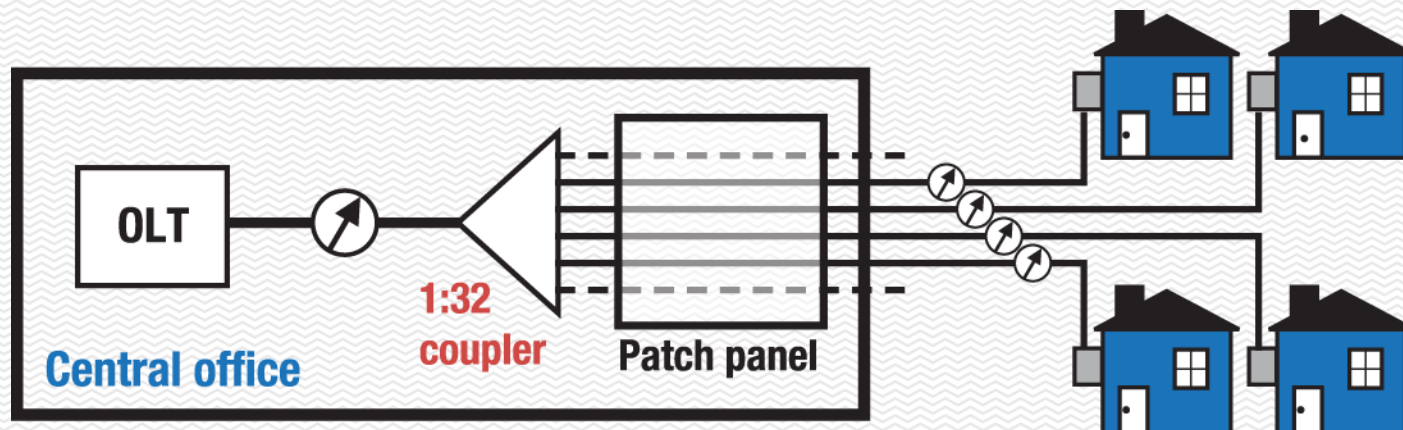

Introduction to Network Components

- Active devices.

- Network elements.
 - OLT, ONT, switches.
- Optical subassemblies.
 - Diplexers, triplexers.
- Components.
 - Lasers, photodiodes.

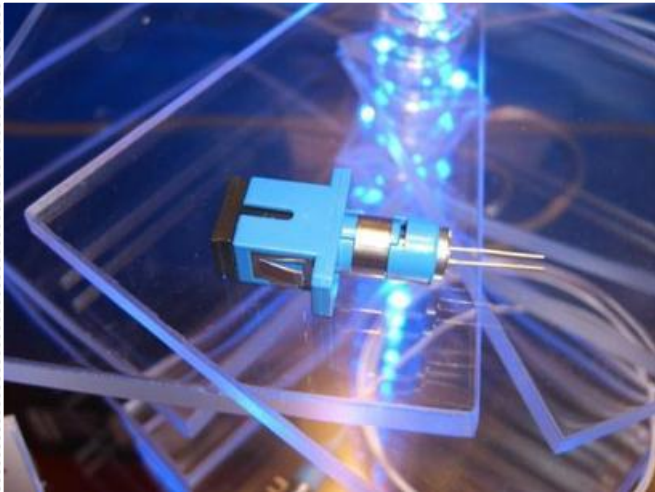

- Passive devices.

- Components.
 - Splitters, WDMs, filters.



Active Devices

- Traditional two fiber transmitters and receivers.
- Bidirectional FTTH transmitters and receivers.
- Diplexers and triplexers.
- SFP, small form factor pluggable.
- XFP, 10 Gigabit small form factor pluggable.



Courtesy Gigacomm

Cable Designs

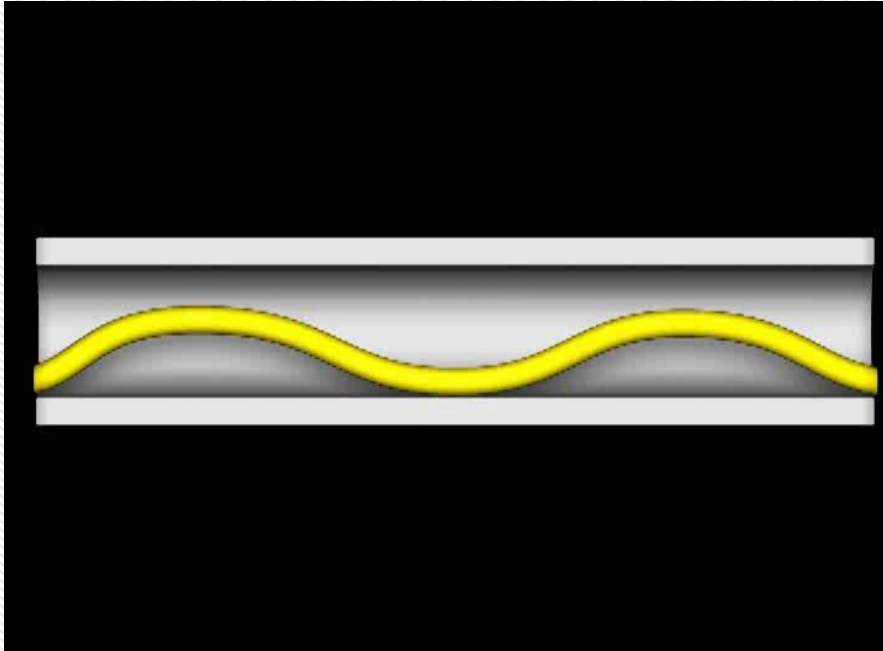

- Loose buffered (OSP).
 - Central tube.
 - Stranded.
 - Armored.
 - Unarmored.
 - Indoor/outdoor.
 - Ribbon.
 - Composite.
 - Moisture intrusion resistance.
- Tight buffered (MDU/MTU).
 - Distribution.
 - Breakout.
 - Cordage.
 - Indoor/outdoor.
 - Composite.
 - Hybrid.

FTTx Drop Cables

- Aerial, ducted and direct buried designs.
- Small fiber counts (<12).
- Rigid central tube designs.
- Tensile strengths of 300 lbs.
- Most designs are oval (versus round).
- Toneable options.
- Preparation tools and process unique to cable design.
- Closure sealing is critical.

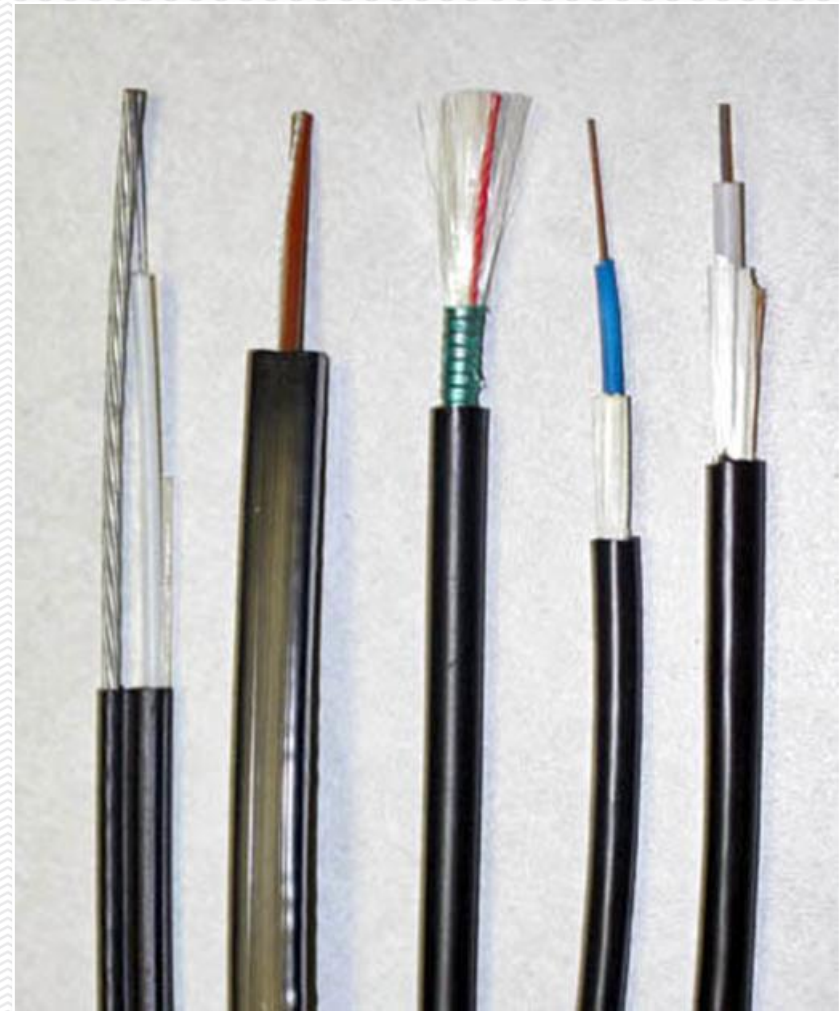

Distribution Cables

- Style, not application
- Indoor, indoor/outdoor.
- Used in riser, plenum, LSZH applications.
- Smallest size and bend radius.
- Tight buffered, 900- μm coating.
- G.657 BIF recommended
- Aramid yarn grouped around all fibers.

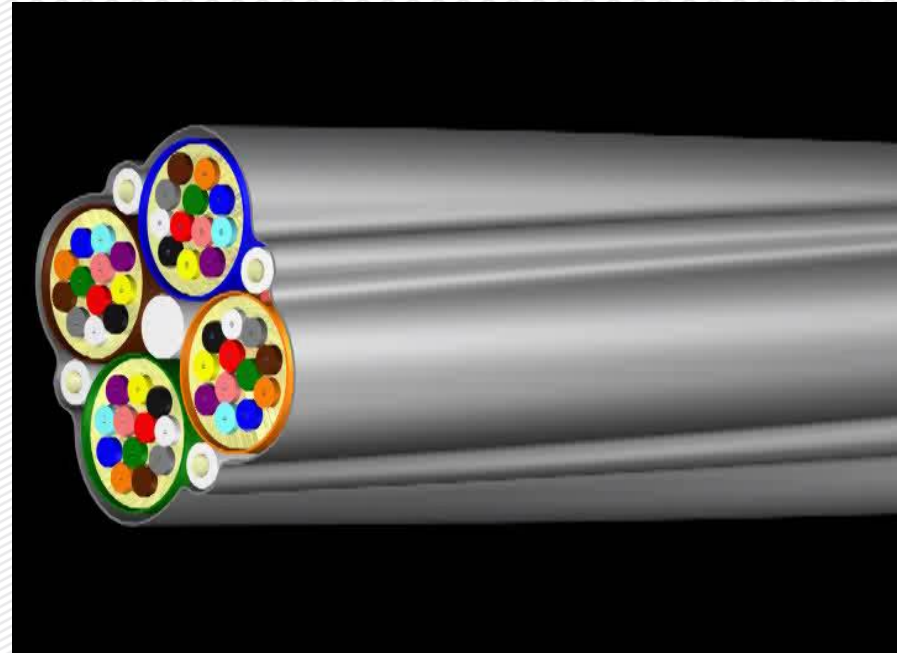

Plenum, Riser, and LSZH Cables

- NEC code requirements.
 - Plenum.
 - Return air handling space.
 - Riser.
 - Vertical space penetrating more than one floor.
- Remember the 50 foot rule (15 meters).
- Cable markings.
 - OFC, OFCP, OFCR, OFCG.
 - OFN, OFNP, OFNR, OFNG.
- LSZH for international code requirements.



Panels, Closures and Cabinets

- Cable management.
- Fiber management.
- Growth and migration.

- Planners should pay attention to flexibility offered by manufacturers.
 - What splitter counts are needed?
 - How are fibers routed and protected?
 - What growth options are provided?
 - Migration and coexistence.

Fiber Optic Interconnect Hardware

Description	CO/OSP Applications	Premises Applications
Fiber distribution frames	Central office, headends, nodes	Large high rises
Distribution panels	Central office, headends, nodes	Building entrance, hub
Splice panels	Central office, building entrance	Building entrance
Optical entrance enclosures	Central office, headends	Building entrance
Fiber distribution hub	Outside plant, serving area hubs	Indoor/outdoor FDH
Splice closures	Outside plant, aerial, vaults	Outside vault, intrabuilding
Premises panels	Fiber to the building	Intrabuilding
Transition terminal	Outside plant, next to ONT	FTTB (MDU/MTU)
Media outlets/MUTOA	N/A	FTTB (MDU/MTU)

Outside Plant Cable Management

- This technique uses two splice closures.
 - Feeder.
 - Distribution.
- All localized drop cables are accessed from the distribution splice closure.



Fiber Distribution Hubs

- Splitter housing.
- Various configurations.
- Feeder to distribution fibers.
- Feeder to drop fibers.
- Cable stubs inbound and outbound.
- Growth and migration.
- Flexibility.
- Pad, pole, and wall mounting.



Courtesy TE Connectivity

Pedestals

- Fiber access terminals.
- Centralized and distributed architectures.
- Urban and rural applications.
- Transition for small fiber routes.
- Mid-entry capable.
- Cross-connect options.

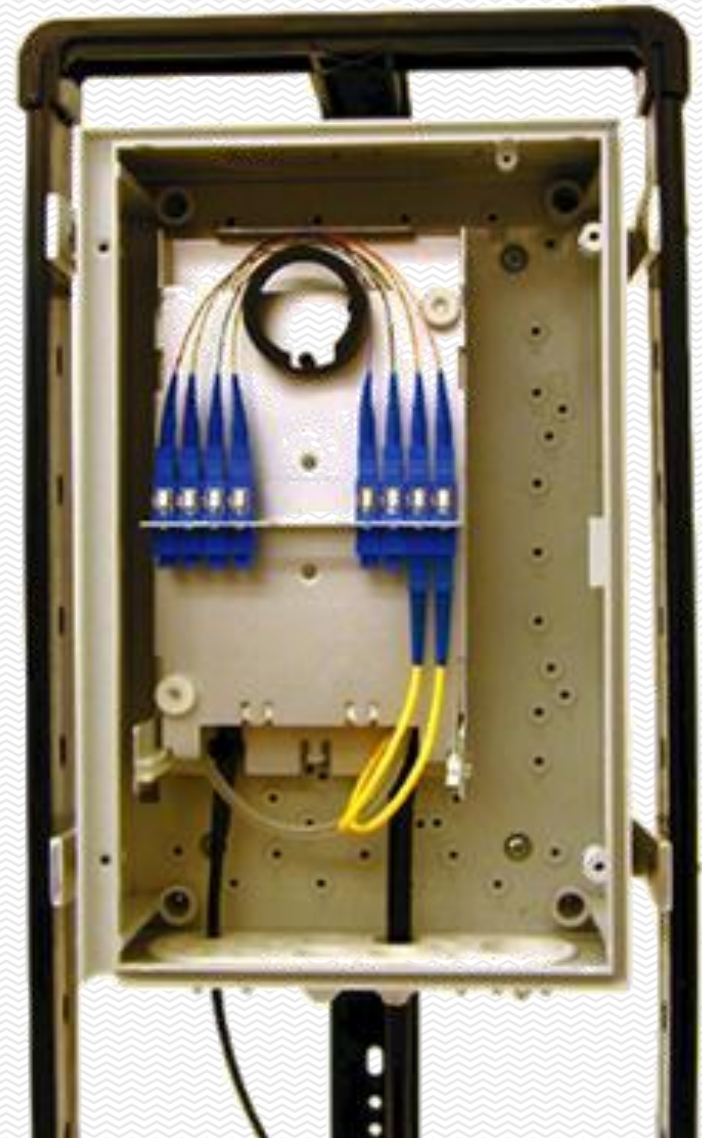

Splice Closures

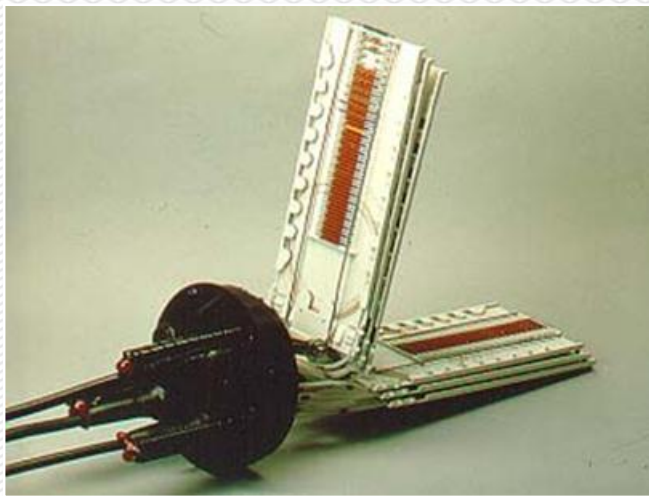

- OSP closure.
 - High fiber counts.
 - In-line or butt style.
 - Larger.
 - Feeder and distribution.

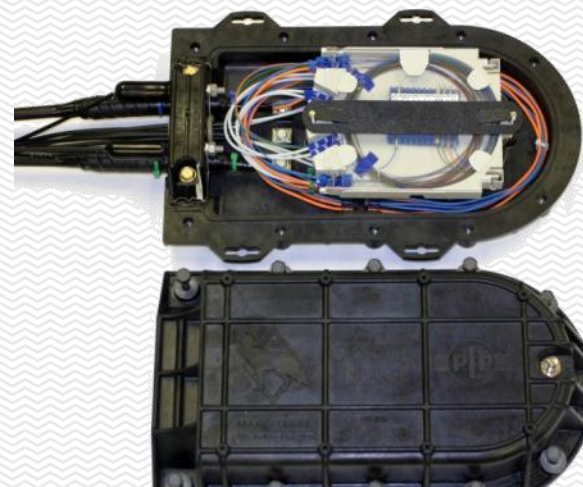

- FTTx closure.
 - Small fiber counts.
 - Butt style.
 - Smaller.
 - Distribution and drops.

Multiport Service Terminals

- Traditional drop cable spliced to distribution fibers.
- MST with hardened connectors.
 - Dust caps.
 - Up to 12 ports.
- Slack storage.
- Mid-entries.
- Environmental sealing.



Fiber Transition Terminals

- Temporary storage.
- Low cost.
- Slack fiber storage.
- Connector options.
- Splice tray options.
- Media converter options.

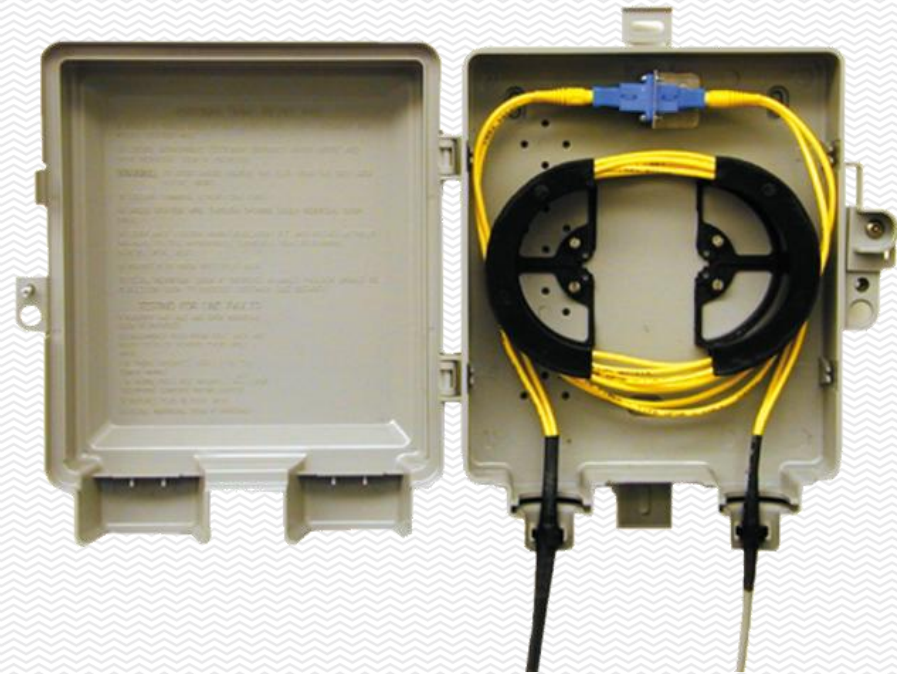

Courtesy Charles Industries

FTTB/MDU Premises Installations

- Secured entrance site.
- Fiber management.
- Centralized cabling.
- G.657 bend-insensitive fiber.
- Customized FTTB products available.
- Preconnectorized options available.

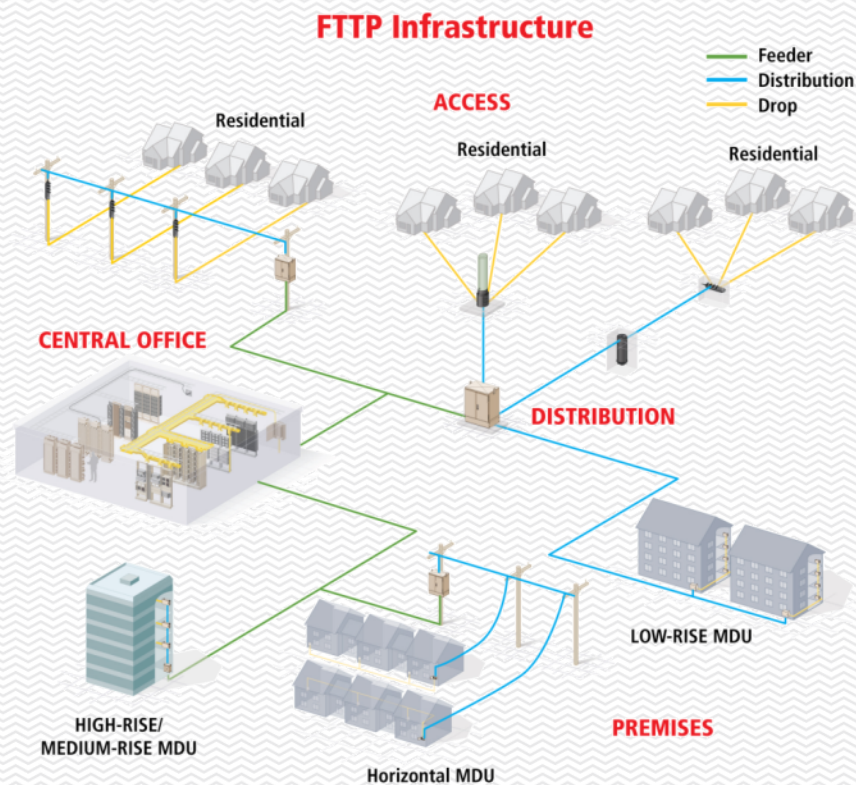

Courtesy TE Connectivity

FTTB Panels

- Wall mounted.
- Provides inbound splice capability.
- Routes drop cables to the client's ONTs.
- Provides transition point per NEC.
- Secured access.



Courtesy TE Connectivity

Hardened Connector Slack Storage

- Aesthetics.
- Location.
 - Subscriber.
 - Pedestal.
 - MST.
 - FDH.



Courtesy Corning Cable Systems



Courtesy Craigville Telephone

Managing Termination Costs

- Greenfield, brownfield.
- FTTH, FTTB.
- Density.
- Architecture.
 - Home run.
 - Centralized.
 - Distributed.
 - Active Ethernet (P2P).
- Termination technique.
- Installed cost.
- Yield.
- Performance.
- Equipment.



Drop Cable Splicing

- Portable and battery powered.
- Tight fiber tolerances.
- Fixed V-groove fusion splicer.
- Mechanical splices.
- No-polish connectors.
- Preterminated hardened drop cables.
- Preterminated pigtails.



What to Look for in a Connector

- Low loss (attenuation).
 - 0.50 dB (ITU-T G.671).
 - 0.40 dB (Telcordia GR-326-CORE).
- Repeatability (keyed).
 - ≤ 0.2 dB (Telcordia GR-326-CORE).
- Reflectivity (in dB).
- Rugged (strain relief).

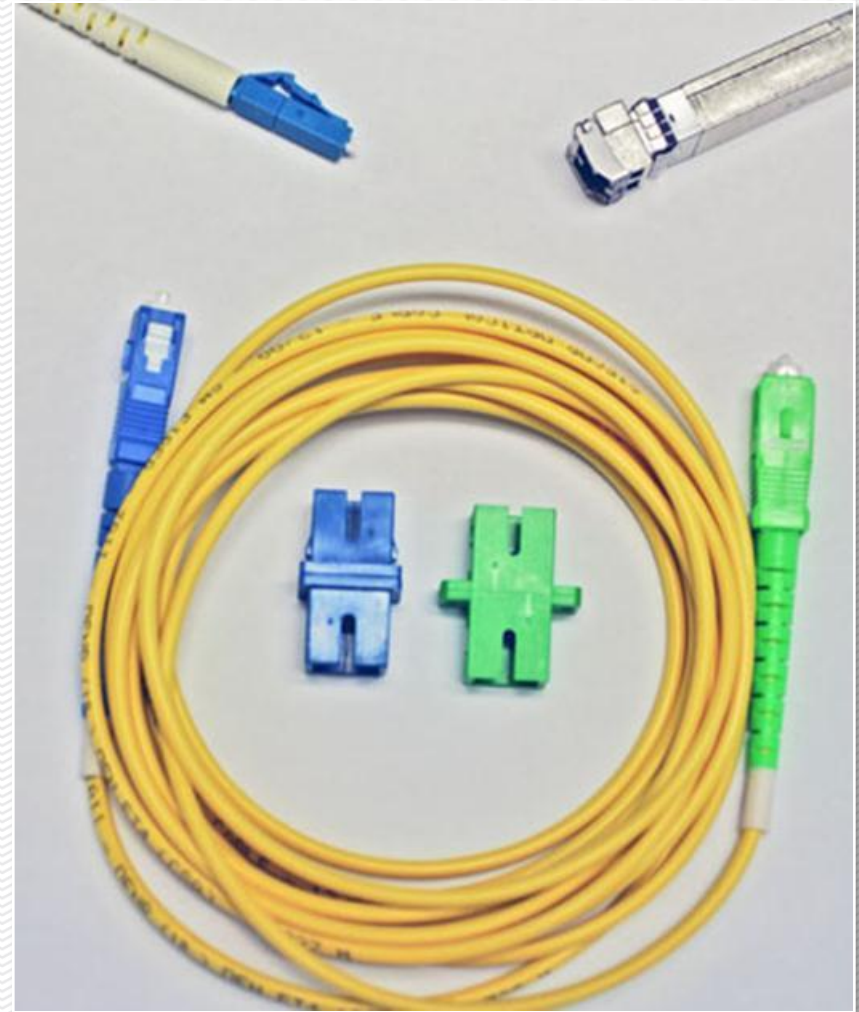

Types of Connections

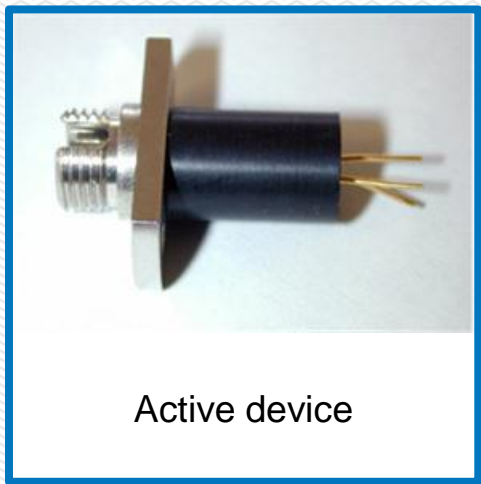
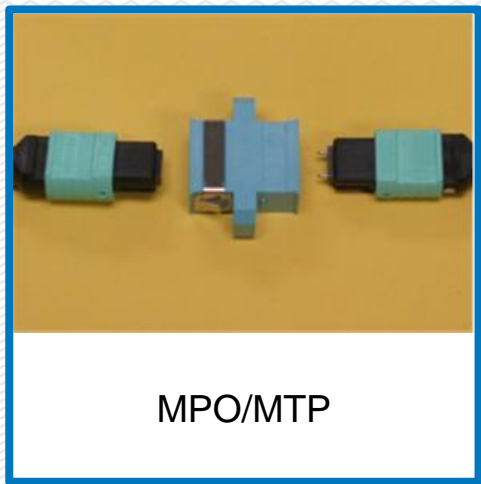
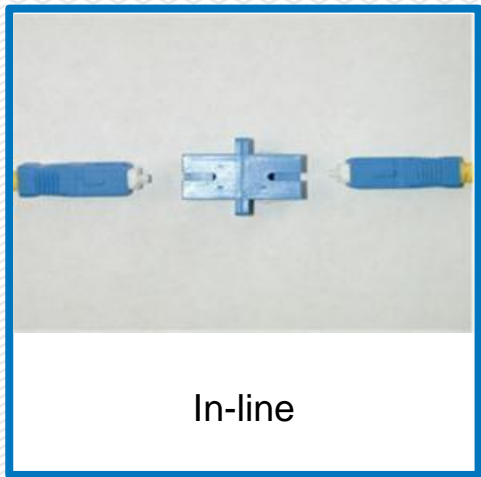

Fiber Optic Connector Polishes

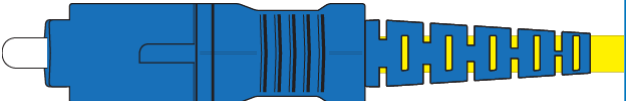
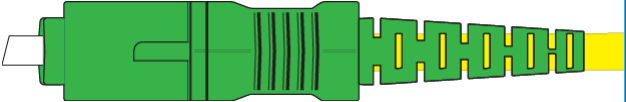
Single-mode Polishes	Reflection	% of Light Reflected
UPC 	55 dB	0.0003%
APC 	65 dB	0.000032%

Non-FTTx Single-mode Polishes	Reflection	% of Light Reflected
Premises	26 dB	0.3%
PC	40 dB	0.01%

Common FTTx Connectors

SC – Subscriber Connector

- Recognized by TIA-604, IEC 61754, and TIA-568 standards.
- Hardened version for drop cables.
- Color coded based on the type of polish.
- Most popular connector worldwide.

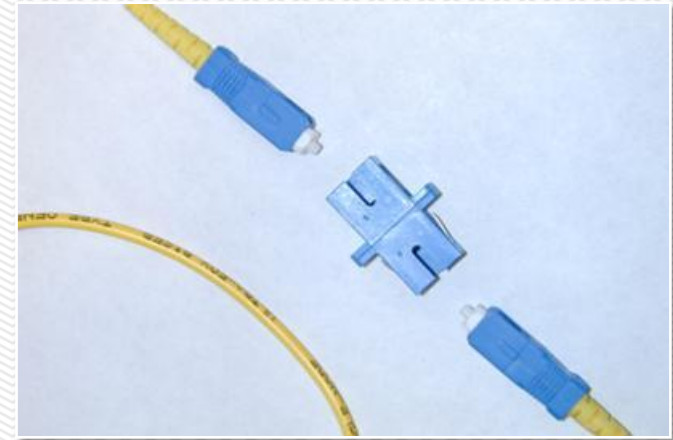

SC/UPC



SC/APC

Hardened Connectors

- Designed to reduce costs in drop cable installations.
- Specified by Telcordia GR-3120.
- Environmentally sealed for OSP and FTTx applications.
- Quick termination to factory-built drop cables.

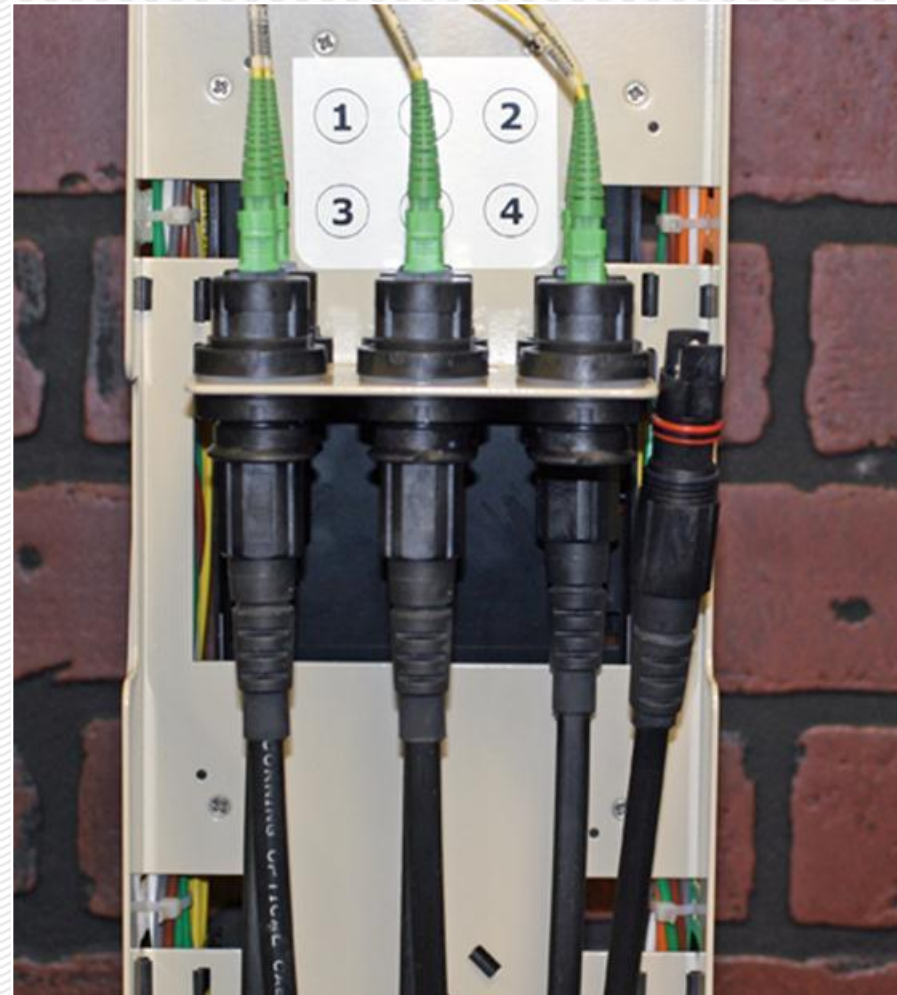

Small Form Factor LC Connectors

- Influenced by DWDM applications.
- Designed for high performance.
- Smaller density and smaller footprint.
- Low loss and low reflectance.
- 1.25-mm ferrule used.
- Standard for SFP and XFP modules.



Multifiber Connectors

- Designed for low-cost applications.
- High fiber count.
 - 24 single-mode fibers.
- Duplex and ribbon connector types.
- MTP/MPO single-mode versions with APC polish.
- Used in FTTB installations.

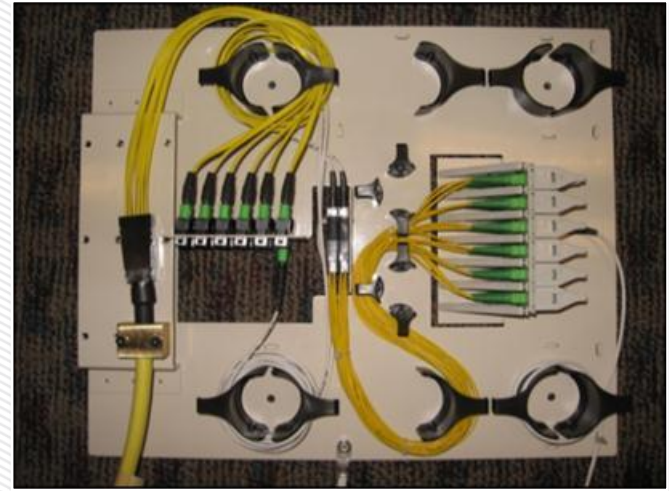

Courtesy TE Connectivity



Courtesy USConec

Field Terminable FTTH Connectors

- Ideal for ONT fiber terminations.
- Meets ITU attenuation and reflectance values.
- UPC and APC polishes.
- Simple terminations.
- Uses mechanical or fusion bonding techniques.
- Quick repairs.

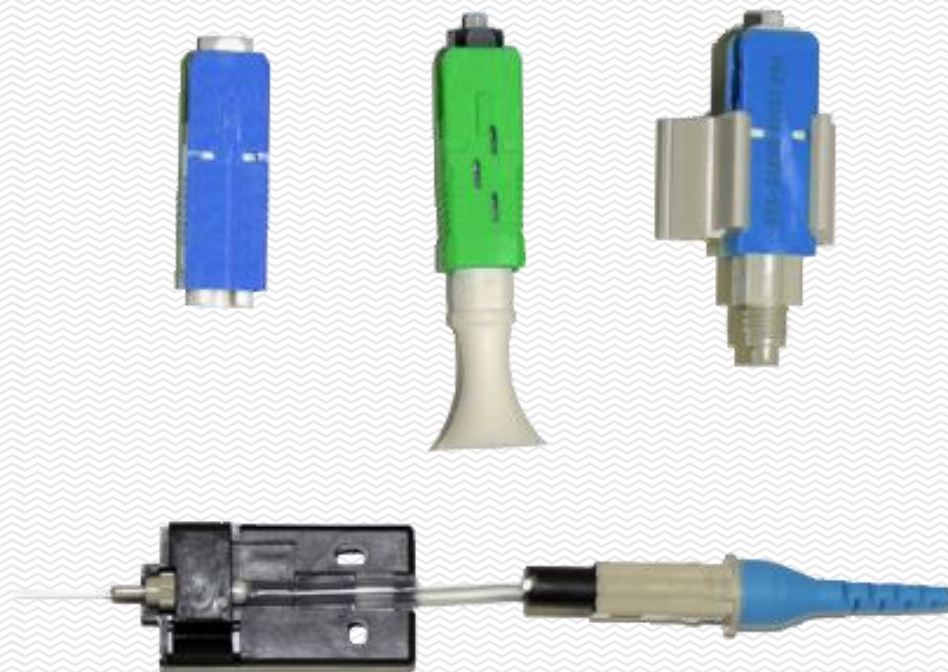

Introduction to Splitter Placement

- All PONs use splitters.
- Application.
 - FTTB, FTTH.
- Design.
 - Centralized.
 - Distributed.
 - Home run.
 - Tapered.
- Splitter products.
- Housing splitters.
- Terminations.
- Location.
- Growth.



Courtesy Charles Industries

Take Rate

- Take rate applies to the number of subscribers per:
 - Per serving area.
 - Per card.
 - Splitter ports.
- Can be specified as a percentage. Will increase as more users subscribe.
- OLT take rate.
 - PON cards.
- Active Ethernet P2P issues.

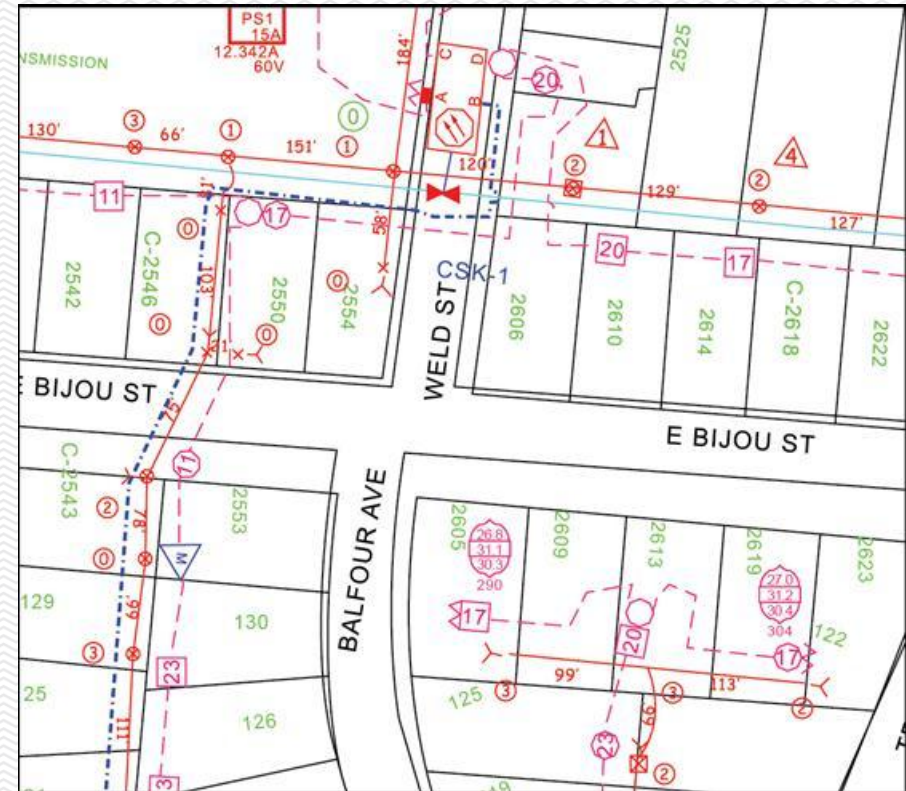

Courtesy SpatialINFO

FTTB/MDU Premises

Installations

- Multiple dwelling units.
 - Apartments, hotels, condominiums, etc.
- Multiple tenant units.
 - Office buildings.
- Structures.
 - High rise.
 - Medium rise.
 - Low rise/garden.
 - Horizontal.



FTTB Systems

- FTTB systems.
 - Active system.
 - Centralized PON.
 - Decentralized PON.
 - Interfaces with contracted services.
 - Solutions vary for indoor MDUs.
- Aesthetics.
 - Where visible, e.g., surface molding.
 - Residences.
 - MUTOA outlets.



Courtesy Corning Cable Systems



Courtesy Alcatel Lucent

FTTB MDU Existing Infrastructure

- Evaluate infrastructure and limitations.
 - Entrance facilities.
 - Risers, space.
 - Communication wiring.
 - Types.
 - Telecom/equipment rooms.
 - Power.
 - Building codes.
 - Building ownership.
- Design considerations.
 - Deployment philosophies.
 - Topology.



Optical Network Terminals and Access Points

- Physical location (inside/outside).
- Electrical power.
- Protection.
- Aesthetics.



Courtesy Tellabs

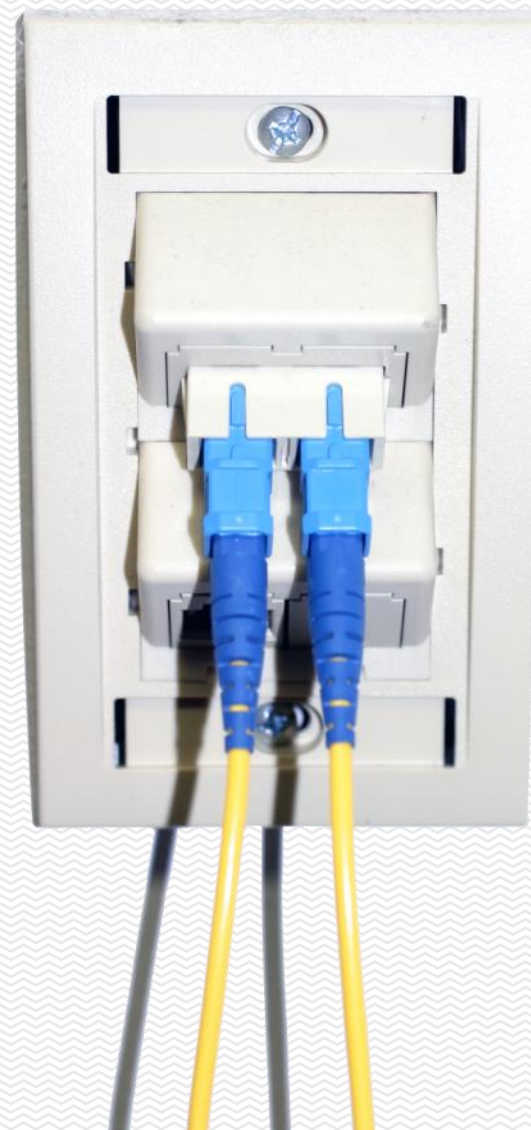

Get Cabling to Each User

- Existing risers and available space.
- Locations and routes.
- OFNR/OFNP/LSZH tight buffered distribution cables.
- Microduct cabling.
- Bend radius concerns (G.657).
- Slack storage.
- Multiple utility spaces available.
- MDU splitter terminal.
- Indoor drop cables (IDC).
- Stubbed pigtails.
- Fiber distribution terminal (FDT).
- Multifiber terminals (MFT).
- Physical protection.



Courtesy TE Connectivity

OmniReach™ Solution

- Minimizes termination costs.
 - MPO ribbon terminations.
- Slack storage on panel.
- Up to 432 fibers.
- Various fiber management options.
- G.657 fiber and cable.

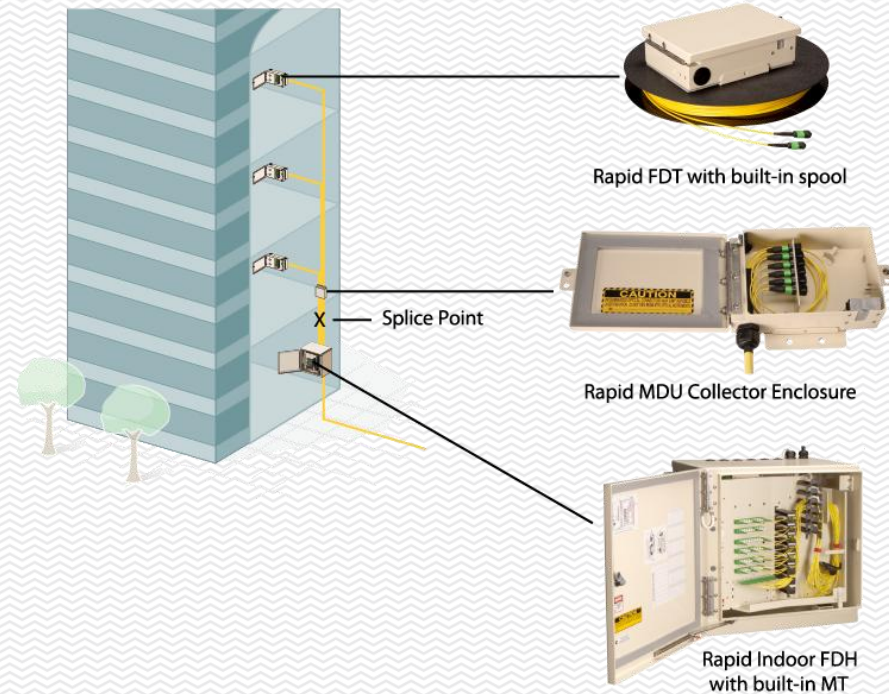

Courtesy TE Connectivity

One Pass™ Solution

- Aesthetics.
- 1-12 fiber units.
- Transition hardware.
- Tooling.
- Passthrough.
- Hallways and inside.
- NPC and terminations.



Courtesy 3M

Invisilight™ Solution

- 900-micron coated G.657 fibers.
- Aesthetic horizontal solution.
- Vertical integration.
- Fiber management products with slack storage.
- Multiple termination options using MPO, SC, or bare fiber.



Courtesy OFS Optics

Loss Budgets for FTTx Networks

- OSP focus.
 - Fiber attenuation.
 - Splitter attenuation.
 - Termination attenuation.
- PON criteria.
 - Identify expected OSP losses.
 - Select required ODN class.
 - Based on splitter attenuation.
 - Based on span distance.
 - Based on margins.
 - Wavelength division multiplexing for RF overlay applications adds 1.0 dB.
- Active Ethernet.
 - Can be longer than 20 km.
 - No splitter losses.

Splitter Specifications

- ITU G.671 components values.
- Wavelength independent couplers (WIC).
 - Bidirectional.
 - FTTH wavelengths.
- Use component values, not theoretical.
- For tapered designs, calculate a loss budget for each drop.

Insertion Loss			
	Maximum	Minimum	Average
1:2	4.2 dB	2.6 dB	3.4 dB
2:2	4.5 dB	2.5 dB	3.9 dB
1:4	7.8 dB	5.4 dB	6.6 dB
2:4	8.1 dB	5.3 dB	7.5 dB
1:8	11.4 dB	8.1 dB	9.7 dB
2:8	11.7 dB	8.0 dB	10.8 dB
1:16	15.0 dB	10.8 dB	12.9 dB
2:16	15.3 dB	10.7 dB	13.5 dB
1:32	18.6 dB	13.1 dB	15.8 dB
2:32	18.9 dB	13.1 dB	17.5 dB
1:64	22.8 dB	15.7 dB	19.2 dB

Theoretical Value		Component Value
1:2 = 3 dB	50%	1:2 ≤ 3.4 dB
1:4 = 6 dB	25%	1:4 < 6.6 dB
1:8 = 9 dB	12.6%	1:8 < 9.7 dB
1:16 = 12 dB	6.25%	1:16 < 13.4 dB
1:32 = 15 dB	3.125%	1:32 < 15.8 dB
1:64 = 18 dB	1.562%	1:64 < 19.2 dB

Splitter Attenuation

Theoretical Value		Component Value	2:n Value
1:2 = 3 dB	50%	1:2 \leq 3.4 dB	2:2 \leq 3.9 dB
1:4 = 6 dB	25%	1:4 < 6.6 dB	2:4 \leq 7.5 dB
1:8 = 9 dB	12.6%	1:8 < 9.7 dB	2:8 \leq 10.8 dB
1:16 = 12 dB	6.25%	1:16 < 13.4 dB	2:16 \leq 13.5 dB
1:32 = 15 dB	3.125%	1:32 < 15.8 dB	2:32 \leq 17.5 dB
1:64 = 18 dB	1.562%	1:64 < 19.2 dB	2:64 \leq 21.4 dB

- ITU-T G.671 values.
- Losses may be higher with connectors and splices.

FTTH Testing and Troubleshooting

- Testing.
- Maintenance.
- Troubleshooting.
- Point to point.
- Point to multipoint.
- Physical layer (OSP).
- Network layer.
- Identify what tests will be performed and what test equipment will be required.



PON Power Meters

- Also known as wavelength isolating power meters.
- Bidirectional testing.
- 1310/1490/1550 nm operation.
- In-line operation.
- Power level measurement.

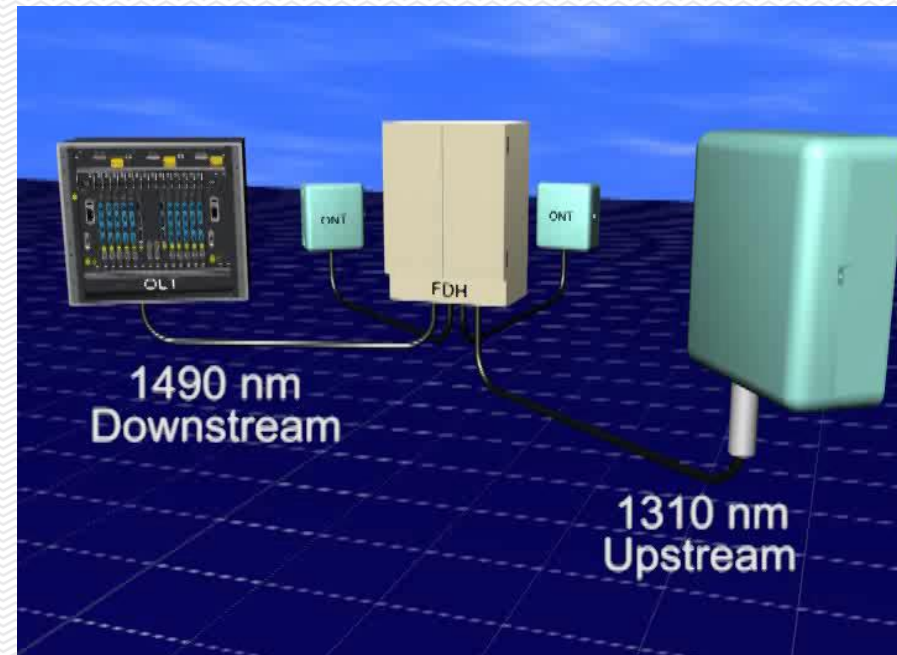

Troubleshooting PON and AE Systems

- When to use the OTDR.
- Testing drop cables.
 - Short spans.
 - Keep it simple.
 - OPM using dBm power levels.
 - $\text{dBm (Tx)} - \text{dBm (Rx)} = \text{dB}$.
- Visual lasers for simple continuity check.
- Testing active Ethernet SFP drop cables uses the same technique.

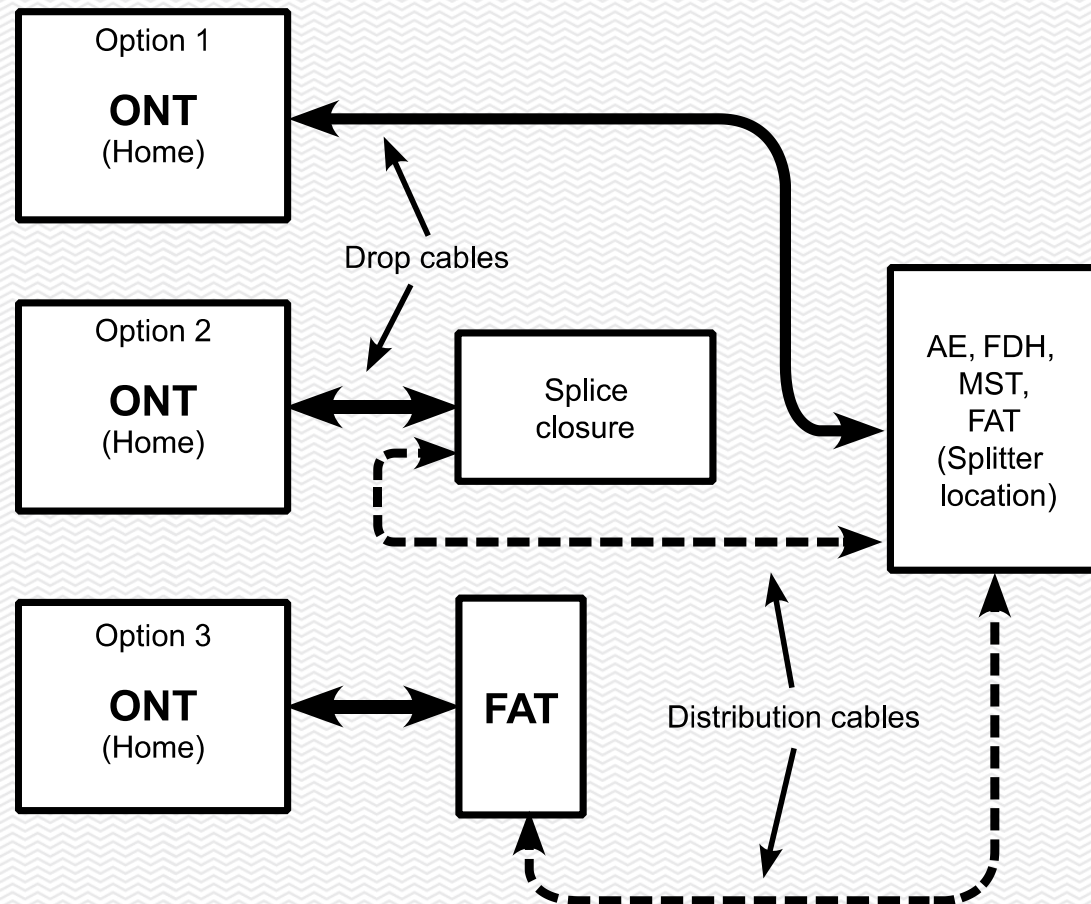

Service Activation Testing

- Optical power.
 - Upstream.
 - Downstream.
- Internet address.
- Data rate.
- Telephone connections.
- Video service.



Question and Answer Session

Visit us in the registration area to pick up your FTTx wavelength allocation chart.

Presented by

The LIGHT BRIGADE

www.lightbrigade.com

This concludes
Introduction to FTTx Networks

Presented by

The LIGHT BRIGADE

www.lightbrigade.com